

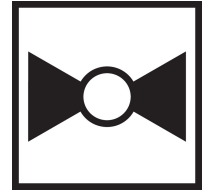

5-year warranty



Technical data

Functional data	Valve Size	2" [50]
	Fluid	chilled or hot water, up to 60% glycol
	Fluid Temp Range (water)	0...250°F [-18...120°C]
	Body Pressure Rating	400 psi
	Close-off pressure Δps	200 psi
	Flow characteristic	equal percentage
	Servicing	maintenance-free
	Flow Pattern	2-way
	Leakage rate	0% for A – AB
	Controllable flow range	75°
	Cv	85
	Cv Flow Rating	A-port: as stated in chart B-port: 70% of A – AB Cv
	Materials	Valve body
Spindle		stainless steel
Spindle seal		EPDM (lubricated)
Seat		PTFE
Characterized disc		stainless steel
Pipe connection		NPT female ends
O-ring		EPDM (lubricated)
Ball		stainless steel
Suitable actuators	Non-Spring	ARB(X)
	Spring	AFRB(X)

Safety notes



- WARNING: This product can expose you to lead which is known to the State of California to cause cancer and reproductive harm. For more information go to www.p65warnings.ca.gov

Product features

Application This valve is typically used in air handling units on heating or cooling coils, and fan coil unit heating or cooling coils. Some other common applications include Unit Ventilators, VAV box re-heat coils and bypass loops. This valve is suitable for use in a hydronic system with variable flow.

Flow/Mounting details

Two-way valves should be installed with the disc upstream.

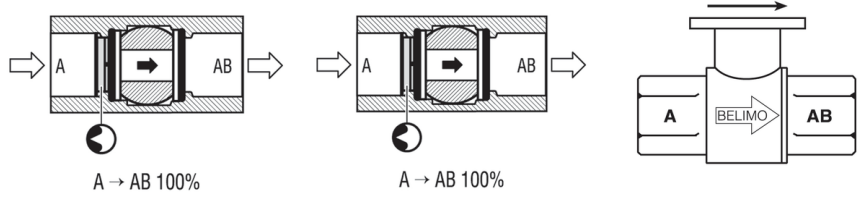

Dimensions

Dimensional drawings

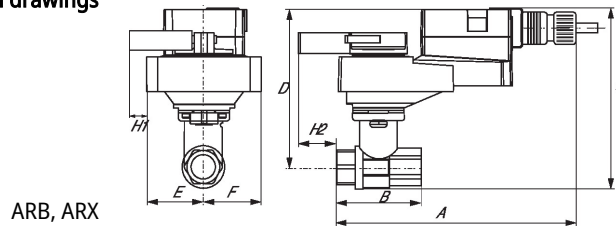

ARB, ARX

A	B	C	D	E	F	H1
10.2" [260]	4.9" [125]	7.7" [196]	6.0" [152]	1.7" [44]	1.7" [44]	1.2" [30]



ARB N4, ARX N4, NRB N4, NRX N4

A	B	C	D	E	F
11.4" [289]	4.9" [125]	9.8" [249]	7.6" [194]	3.1" [80]	3.1" [80]



ARQB, ARQX

A	B	C	D	E	F	H1	H2
9.9" [251]	4.9" [125]	7.5" [191]	6.1" [155]	2.3" [58]	2.3" [58]	0.8" [20]	0.6" [15]

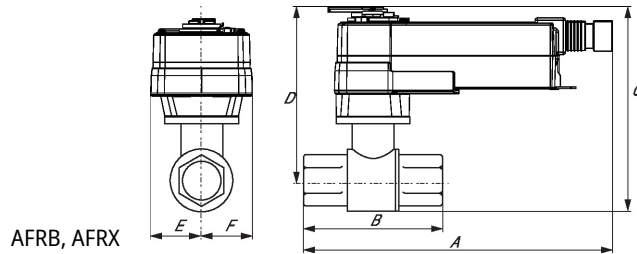

AFRB, AFRX

A	B	C	D	E	F
11.3" [286]	4.9" [125]	10.6" [268]	8.9" [225]	2.0" [51]	2.0" [51]

AFRB N4, AFRX N4



A	B	C	D	E	F
13.0" [330]	4.9" [125]	10.3" [262]	9.3" [235]	3.4" [86]	3.4" [86]



5-year warranty



Technical data

Electrical data	Nominal voltage	AC/DC 24 V
	Nominal voltage frequency	50/60 Hz
	Power consumption in operation	2.5 W
	Power consumption in rest position	0.5 W
	Transformer sizing	5.5 VA (class 2 power source)
	Auxiliary switch	1 x SPDT, 3 A resistive (0.5 A inductive) @ AC 250 V, adjustable 0...100%
	Switching capacity auxiliary switch	3 A resistive (0.5 A inductive) @ AC 250 V
	Electrical Connection	18 GA plenum cable with 1/2" conduit connector, degree of protection NEMA 2 / IP54, 3 ft [1 m] 10 ft [3 m] and 16ft [5 m]
	Overload Protection	electronic throughout 0...90° rotation
Functional data	Direction of motion motor	selectable with switch 0/1
	Manual override	external push button
	Angle of rotation	90°
	Angle of rotation note	adjustable with mechanical stop
	Running Time (Motor)	90 s / 90°
	Running time motor variable	90 or 150 s
	Noise level, motor	45 dB(A)
	Position indication	Mechanically, pluggable
Safety data	Degree of protection IEC/EN	IP54
	Degree of protection NEMA/UL	NEMA 2
	Enclosure	UL Enclosure Type 2
	Agency Listing	cULus acc. to UL60730-1A/-2-14, CAN/CSA E60730-1:02, CE acc. to 2014/30/EU and 2014/35/EU; Listed to UL 2043 - suitable for use in air plenums per Section 300.22(c) of the NEC and Section 602.2 of the IMC
	Quality Standard	ISO 9001
	Ambient temperature	-22...122°F [-30...50°C]
	Storage temperature	-40...176°F [-40...80°C]
	Ambient humidity	Max. 95% RH, non-condensing
	Servicing	maintenance-free
	Materials	Housing material

Footnotes †Rated Impulse Voltage 800V, Type action 1.B, Control Pollution Degree 3.

Accessories

Electrical accessories	Description	Type
	Battery backup system, for non-spring return models	NSV24 US
	Battery, 12 V, 1.2 Ah (two required)	NSV-BAT

Electrical installation

✂ INSTALLATION NOTES

- 1** Provide overload protection and disconnect as required.
- 2** Actuators may be connected in parallel. Power consumption and input impedance must be observed.
- 3** Actuators may also be powered by DC 24 V.
- 6** Actuators Hot wire must be connected to the control board common. Only connect common to neg. (-) leg of control circuits. Terminal models (-T) have no-feedback.
- 18** Actuators with plenum cable do not have numbers; use color codes instead.
- 44** One built-in auxiliary switch (1x SPDT), for end position indication, interlock control, fan startup, etc.
- ⚡** Apply only AC line voltage or only UL-Class 2 voltage to the terminals of auxiliary switches. Mixed or combined operation of line voltage/safety extra low voltage is not allowed.
- ◆** Meets cULus requirements without the need of an electrical ground connection.
- ⚠ Warning! Live electrical components!**
During installation, testing, servicing and troubleshooting of this product, it may be necessary to work with live electrical components. Have a qualified licensed electrician or other individual who has been properly trained in handling live electrical components perform these tasks. Failure to follow all electrical safety precautions when exposed to live electrical components could result in death or serious injury.

Wiring diagrams

On/Off

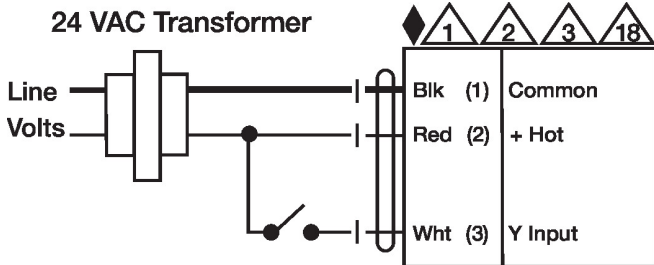

Floating Point

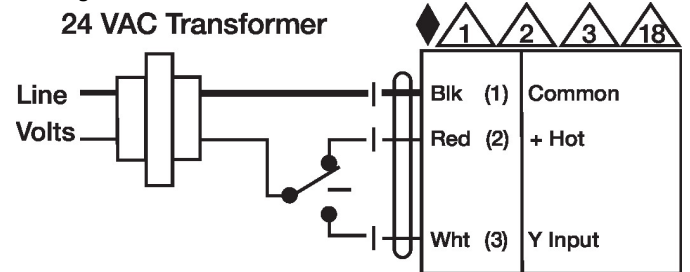

24 VAC Transformer

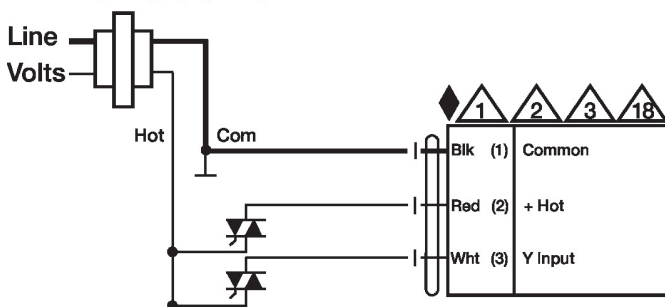

Floating Point - Triac Sink

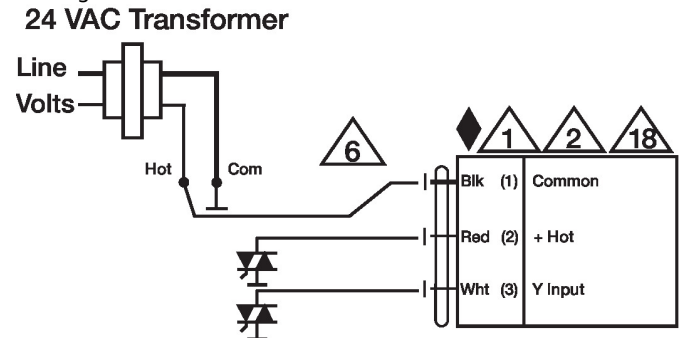

Auxiliary Switches

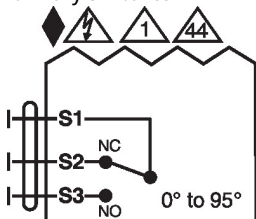

Dimensions