



5-year warranty



Technical data

Functional data	Valve Size	1" [25]
	Fluid	chilled or hot water, up to 60% glycol
	Fluid Temp Range (water)	0...250°F [-18...120°C]
	Body Pressure Rating	600 psi
	Body pressure rating note	600 psi
	Close-off pressure Δps	200 psi
	Flow characteristic	A-port equal percentage, B-port modified for constant common port flow
	Servicing	maintenance-free
	Flow Pattern	3-way Mixing/Diverting
	Leakage rate	0% for A – AB, <2.0% for B – AB
	Controllable flow range	75°
	Cv	10
	Cv Flow Rating	A-port: as stated in chart B-port: 70% of A – AB Cv
Materials	Valve body	Nickel-plated brass body
	Stem	stainless steel
	Stem seal	EPDM (lubricated)
	Seat	PTFE
	Characterizing disk	TEFZEL®
	Pipe connection	NPT female ends
	O-ring	EPDM (lubricated)
	Ball	stainless steel
Suitable actuators	Non-Spring	LRB(X) NRB(X) N4
	Spring	LF

Safety notes



- WARNING: This product can expose you to lead which is known to the State of California to cause cancer and reproductive harm. For more information go to www.p65warnings.ca.gov

Product features

Application This valve is typically used in air handling units on heating or cooling coils, and fan coil unit heating or cooling coils. Some other common applications include Unit Ventilators, VAV box re-heat coils and bypass loops. This valve is suitable for use in a hydronic system with variable or constant flow.

Flow/Mounting details



Dimensions

Dimensional drawings

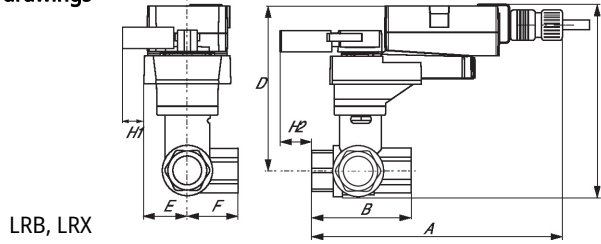

LRB, LRX

Type

DN

Weight [kg]
[kg]

B323

25

0.60

A	B	C	D	E	F	H1	H2
8.5" [216]	3.1" [78]	5.9" [150]	5.1" [129]	1.3" [33]	1.6" [40]	1.2" [30]	0.9" [23]

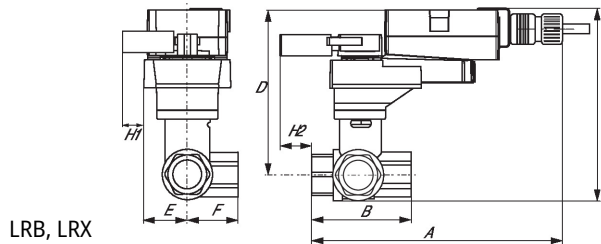

LRB, LRX

A	B	C	D	E	F	H1	H2
9.4" [239]	3.1" [78]	7.2" [184]	6.3" [161]	1.3" [33]	1.3" [33]	1.2" [30]	0.9" [23]

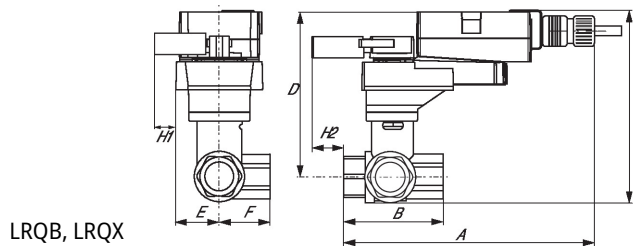

LRQB, LRQX

A	B	C	D	E	F	H1	H2
8.9" [226]	3.1" [78]	6.7" [169]	5.6" [142]	1.6" [40]	1.6" [40]	1.2" [30]	1" [25]

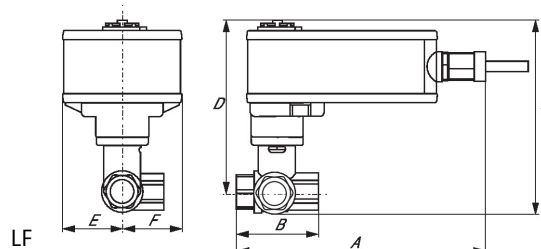

LF

A	B	C	D	E	F
8.1" [206]	3.1" [78]	6.5" [165]	5.6" [142]	1.9" [48]	1.9" [48]



5-year warranty



Technical data

Electrical data	Nominal voltage	AC/DC 24 V
	Nominal voltage frequency	50/60 Hz
	Power consumption in operation	1.5 W
	Power consumption in rest position	0.2 W
	Transformer sizing	2.5 VA (class 2 power source)
	Electrical Connection	Screw terminal (for 26 to 14 GA wire)
	Overload Protection	electronic throughout 0...90° rotation
	Electrical Protection	actuators are double insulated
Functional data	Direction of motion motor	selectable with switch 0/1
	Manual override	external push button
	Angle of rotation	90°
	Angle of rotation note	adjustable with mechanical stop
	Running Time (Motor)	default 90 s, variable 150, 90, 45, 35 s
	Running time motor variable	150, 90, 45, 35 s
	Noise level, motor	35 dB(A)
	Position indication	Mechanically, pluggable
Safety data	Degree of protection IEC/EN	IP54
	Degree of protection NEMA/UL	NEMA 2
	Enclosure	UL Enclosure Type 2
	Agency Listing	cULus acc. to UL60730-1A/-2-14, CAN/CSA E60730-1:02, CE acc. to 2014/30/EU Listed to UL 2043 - suitable for use in air plenums per Section 300.22(C) of the NEC and Section 602 of the IMC
	Quality Standard	ISO 9001
	Ambient temperature	-22...122°F [-30...50°C]
	Storage temperature	-40...176°F [-40...80°C]
	Ambient humidity	Max. 95% RH, non-condensing
	Servicing	maintenance-free
	Weight	Weight

Accessories

Electrical accessories	Description	Type
	Battery backup system, for non-spring return models	NSV24 US
	Battery, 12 V, 1.2 Ah (two required)	NSV-BAT
	Auxiliary switch 1 x SPDT add-on	S1A
	Auxiliary switch 2 x SPDT add-on	S2A
	Feedback potentiometer 140 Ω add-on, grey	P140A GR
	Feedback potentiometer 1 kΩ add-on, grey	P1000A GR
	Feedback potentiometer 10 kΩ add-on, grey	P10000A GR
	Feedback potentiometer 2.8 kΩ add-on, grey	P2800A GR
	Feedback potentiometer 500 Ω add-on, grey	P500A GR
	Feedback potentiometer 5 kΩ add-on, grey	P5000A GR

Electrical installation

✂ INSTALLATION NOTES

- ⚠ Provide overload protection and disconnect as required.
- ⚠ Actuators may be connected in parallel. Power consumption and input impedance must be observed.
- ⚠ Actuators may also be powered by DC 24 V.
- ⚠ Actuators Hot wire must be connected to the control board common. Only connect common to neg. (-) leg of control circuits. Terminal models (-T) have no-feedback.
- ⚠ Actuators are provided with a numbered screw terminal strip instead of a cable.
- ◆ Meets cULus requirements without the need of an electrical ground connection.
- ⚠ **Warning! Live electrical components!**

During installation, testing, servicing and troubleshooting of this product, it may be necessary to work with live electrical components. Have a qualified licensed electrician or other individual who has been properly trained in handling live electrical components perform these tasks. Failure to follow all electrical safety precautions when exposed to live electrical components could result in death or serious injury.

Wiring diagrams

On/Off

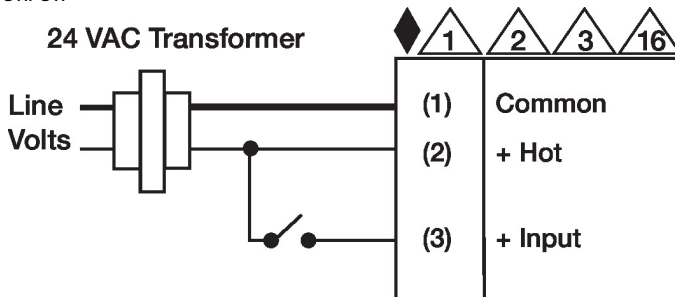

Floating Point

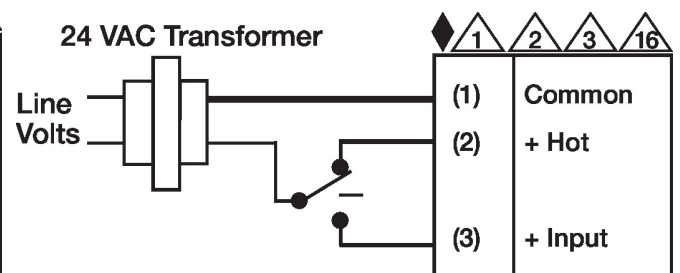

Floating Point - Triac Source
24 VAC Transformer

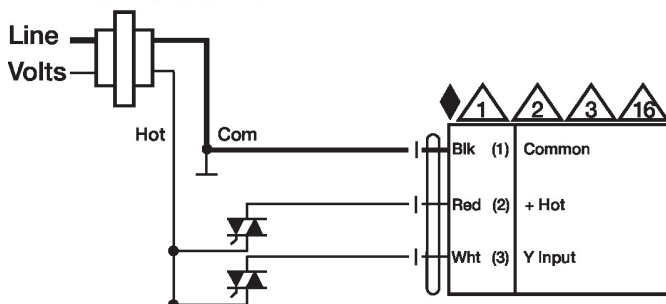

Floating Point - Triac Sink
24 VAC Transformer

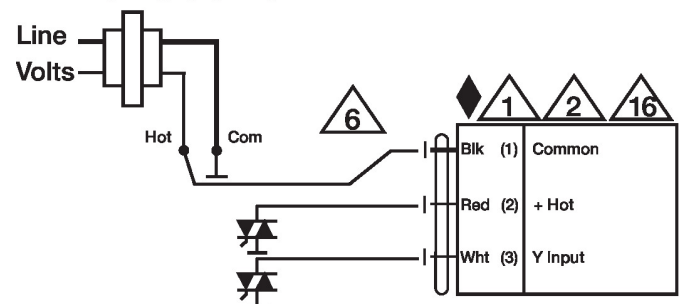

Dimensions