

Butterfly Valve with Lug types

- Disc 304 stainless steel
- Bubble tight shut-off
- Resilient seat
- Valve face-to-face dimensions comply with API 609 & MSS-SP-67
- Completely assembled and tested, ready for installation



5-year warranty

Type overview

Type	DN
F6125HD	125

Technical data

Functional data	Valve size [mm]	5" [125]
	Fluid	chilled or hot water, up to 60% glycol
	Fluid Temp Range (water)	-22...250°F [-30...120°C]
	Body Pressure Rating	ANSI Class Consistent with 125, 232 psi CWP
	Close-off pressure Δ ps	200 psi
	Flow characteristic	modified equal percentage
	Leakage rate	0% leakage, leakage rate A
	Servicing	maintenance-free
	Flow Pattern	2-way
	Controllable flow range	90° rotation
	Cv	1022
	Maximum Velocity	12 FPS
	Lug threads	3/4-10 UNC
Materials	Valve body	Ductile cast iron ASTM A536
	Body finish	epoxy powder coating (blue RAL 5002)
	Stem	416 stainless steel
	Stem seal	EPDM (lubricated)
	Seat	EPDM
	Pipe connection	for use with ANSI class 125/150 flanges
	Bearing	RPTFE
	Disc	304 stainless steel
Gear operator materials	Gears - hardened steel	
Suitable actuators	Non-Spring	DRB(X) PRB(X)
	Electrical fail-safe	PKRB(X)

Product features

Flow/Mounting details



Dimensions

Type	DN	Weight
F6125HD	125	17 lb [7.5 kg]

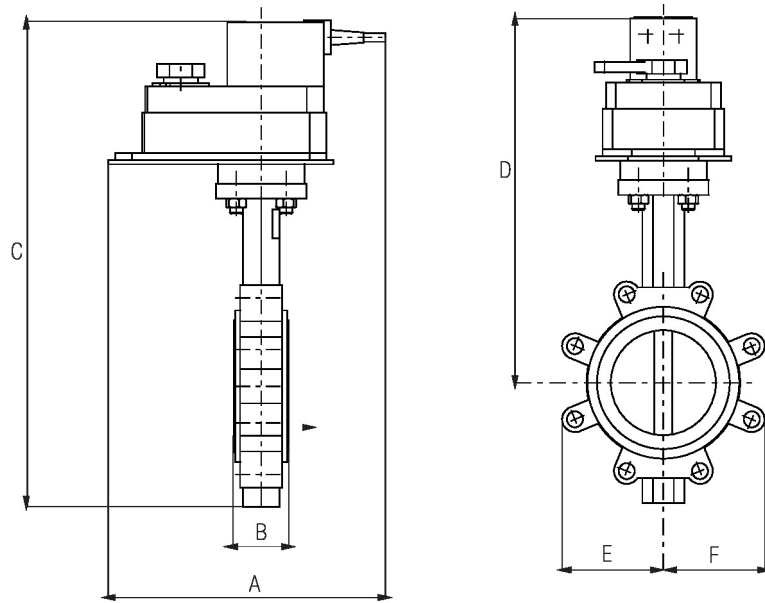

Valve with DRB, DKRB Actuator

A	B	C	D	E	F	Number of Bolt Holes
11.3" [286]	2.3" [58]	17.9" [454]	13.6" [345]	4.9" [124]	4.9" [125]	8

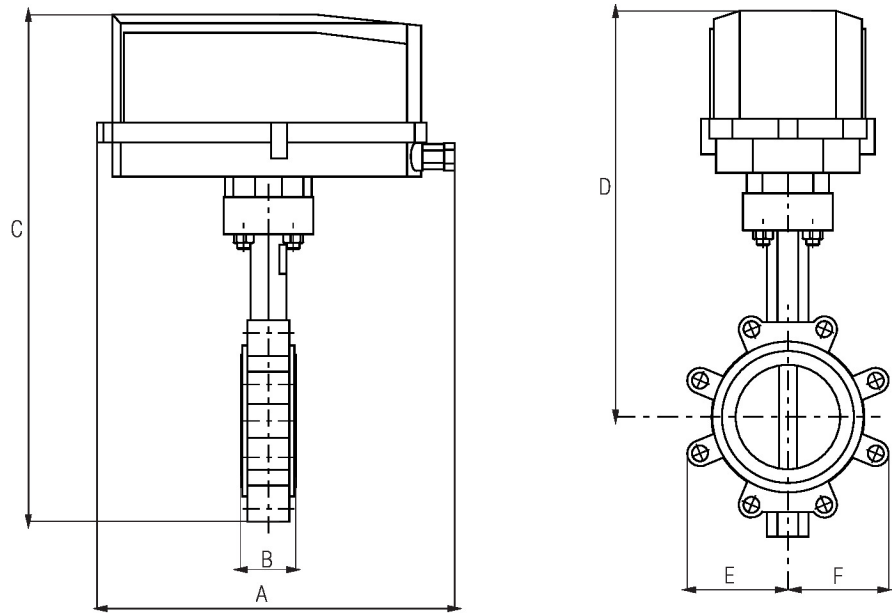

Valve with DRB..N4, DKRB..N4 Actuator

A	B	C	D	E	F	Number of Bolt Holes
14.1" [358]	2.3" [58]	20.0" [509]	15.7" [399]	4.9" [124]	4.9" [125]	8

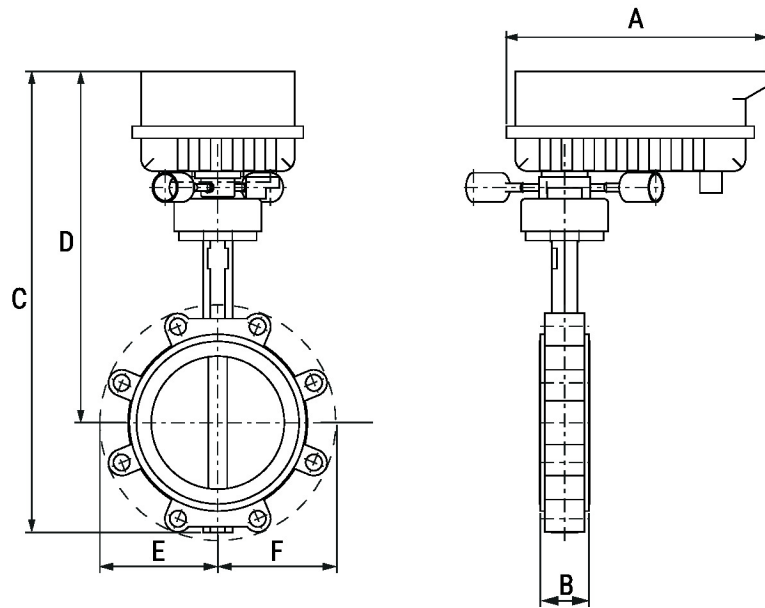

Valve with PRB(X) Actuator

A	B	C	D	E	F	Number of Bolt Holes
12.0" [304]	2.3" [58]	19.9" [506]	15.5" [394]	4.9" [124]	4.9" [125]	8

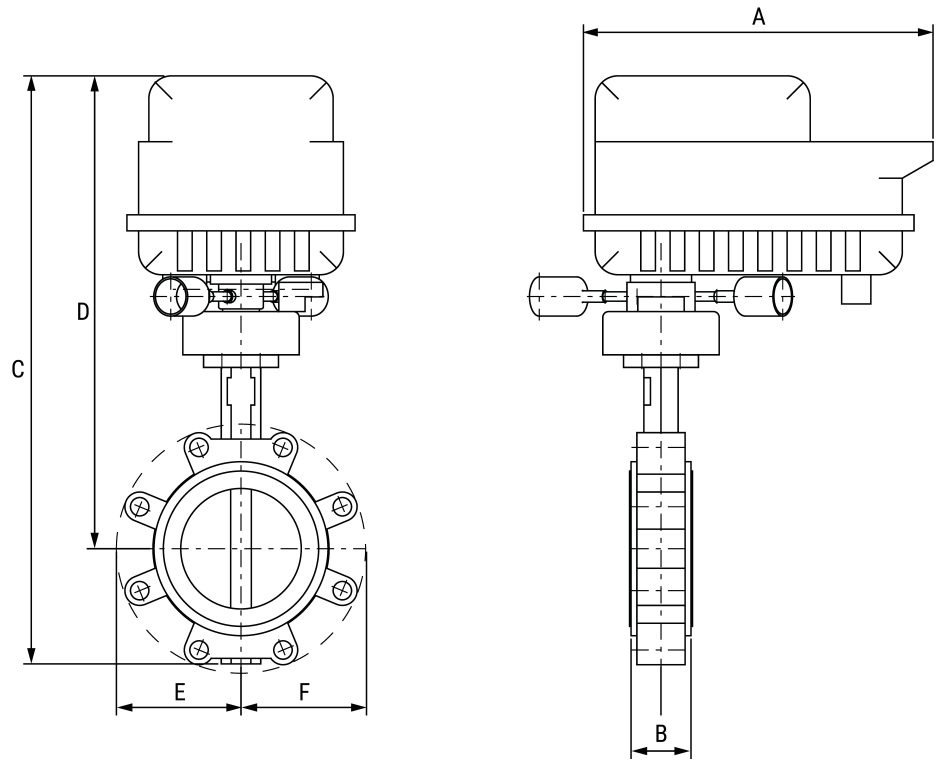

Valve with PKR Actuator

A	B	C	D	E	F	Number of Bolt Holes
12.0" [304]	2.3" [58]	22.1" [562]	17.8" [453]	4.9" [124]	4.9" [125]	8

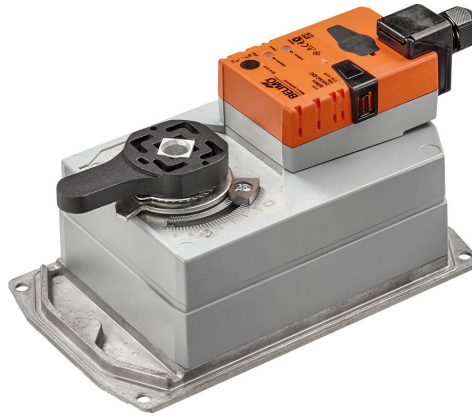

5-year warranty



Technical data

Electrical data	Nominal voltage	AC/DC 24 V
	Nominal voltage frequency	50/60 Hz
	Nominal voltage range	AC 19.2...28.8 V / DC 21.6...28.8 V
	Power consumption in operation	12 W
	Power consumption in rest position	3 W
	Transformer sizing	21 VA
	Electrical Connection	Screw terminal (for 22 to 12 AWG wire)
	Overload Protection	electronic throughout 0...90° rotation
Functional data	Direction of motion motor	selectable with switch 0/1
	Manual override	external push button
	Running Time (Motor)	35 s / 90°
	Running time motor note	constant, independent of load
	Noise level, motor	45 dB(A)
	Position indication	integrated into handle
Safety data	Power source UL	Class 2 Supply
	Degree of protection IEC/EN	IP54
	Degree of protection NEMA/UL	NEMA 2
	Enclosure	UL Enclosure Type 2
	Quality Standard	ISO 9001
	UL 2043 Compliant	Suitable for use in air plenums per Section 300.22(C) of the NEC and Section 602 of the IMC
	Ambient humidity	Max. 95% RH, non-condensing
	Ambient temperature	-22...122°F [-30...50°C]
	Storage temperature	-40...176°F [-40...80°C]
	Servicing	maintenance-free
Weight	Weight	2.8 lb [1.3 kg]
Materials	Housing material	Die cast aluminium and plastic casing
Footnotes	Control Signal must be specified at time of order. Control cannot be changed via field wiring.	

Accessories

Electrical accessories	Description	Type
	Battery backup system, for non-spring return models	NSV24 US
	Battery, 12 V, 1.2 Ah (two required)	NSV-BAT
	Auxiliary switch 1x SPDT add-on	S1A
	Auxiliary switch 2x SPDT add-on	S2A
	Feedback potentiometer 140 Ω add-on, grey	P140A GR
	Feedback potentiometer 5 kΩ add-on, grey	P5000A GR
	Feedback potentiometer 1 kΩ add-on, grey	P1000A GR
	Feedback potentiometer 2.8 kΩ add-on, grey	P2800A GR
	Feedback potentiometer 500 Ω add-on, grey	P500A GR
	Feedback potentiometer 10 kΩ add-on, grey	P10000A GR
Mechanical accessories	Description	Type
	Terminal-strip cover for NEMA 2 rating (-T models).	ZS-T

Electrical installation

⚡ INSTALLATION NOTES

- ⚠ Provide overload protection and disconnect as required.
- ⚠ Actuators may also be powered by DC 24 V.
- ⚠ For triac sink the Common connection from the actuator must be connected to the Hot connection of the controller. Position feedback cannot be used with a triac sink controller; the actuator internal common reference is not compatible.
- ⚠ IN4004 or IN4007 diode. (IN4007 supplied, Belimo part number 40155).
- ⚠ Actuators are provided with a numbered screw terminal strip instead of a cable.
- ◆ Meets cULus requirements without the need of an electrical ground connection.
- ⚠ **Warning! Live electrical components!**
During installation, testing, servicing and troubleshooting of this product, it may be necessary to work with live electrical components. Have a qualified licensed electrician or other individual who has been properly trained in handling live electrical components perform these tasks. Failure to follow all electrical safety precautions when exposed to live electrical components could result in death or serious injury.

Wiring diagrams

On/Off

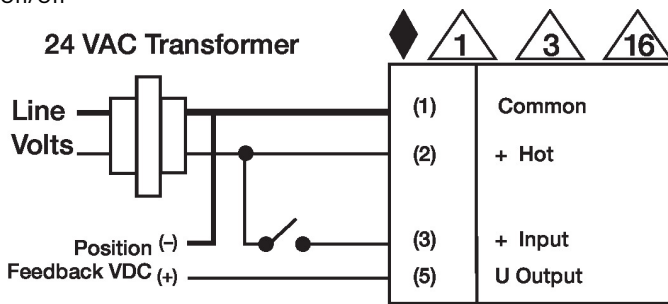

Floating Point

