



5-year warranty

**Technical data**

<b>Functional data</b>	Valve Size	3" [80]
	Fluid	chilled or hot water, up to 60% glycol
	Fluid Temp Range (water)	-20...350°F [-30...176°C]
	Body Pressure Rating	ANSI Class 125, up to 175 psi below 150°F
	Flow characteristic	linear
	Servicing	repack/rebuild kits available
	Rangeability Sv	50:1
	Flow Pattern	3-way Mixing
	Leakage rate	ANSI Class III
	Controllable flow range	stem up - open B – AB
	Cv	85
	ANSI Class	125
	Body pressure rating note	up to 175 psi below 150°F
<b>Materials</b>	Valve body	Cast iron - ASTM A126 Class B
	Valve plug	Stainless steel
	Stem seal	NLP EPDM (no lip packing)
	Seat	Stainless steel AISI 316
	Pipe connection	125 lb flanged
<b>Suitable actuators</b>	Non-Spring	EVB(X) RVB(X)
	Electronic fail-safe	AVKB(X) (2*GKB(X))

**Safety notes**

- **WARNING:** This product can expose you to lead which is known to the State of California to cause cancer and reproductive harm. For more information go to [www.p65warnings.ca.gov](http://www.p65warnings.ca.gov)
- The valve has been designed for use in stationary heating, ventilation and air-conditioning systems and must not be used outside the specified field of application, especially in aircraft or in any other airborne means of transport.
- Only authorised specialists may carry out installation. All applicable legal or institutional installation regulations must be complied during installation.
- The valve does not contain any parts that can be replaced or repaired by the user.
- When determining the flow rate characteristic of controlled devices, the recognised directives must be observed.

**Product features**

Flow/Mounting details

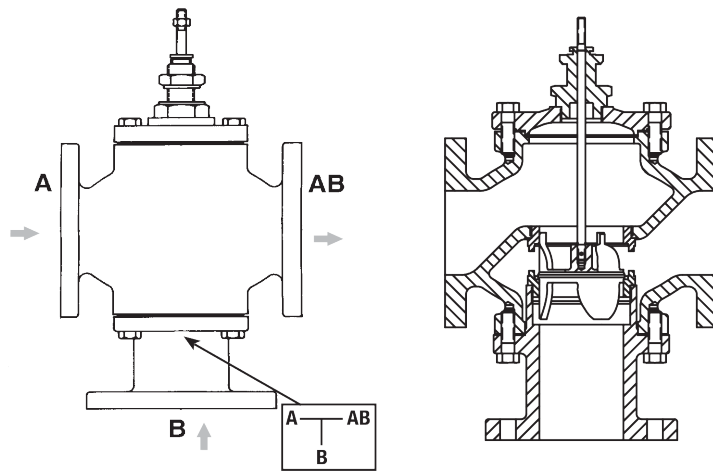

Dimensions

Dimensional drawings

EVB, EVX, RVB, RVX



A	B	C	D	E	F	Number of Bolt Holes
12.2" [310]	10.0" [254]	27.0" [686]	19.0" [483]	3.9" [100]	3.9" [100]	4

2\*GMB, 2\*GMX, 2\*GKB, 2\*GKX

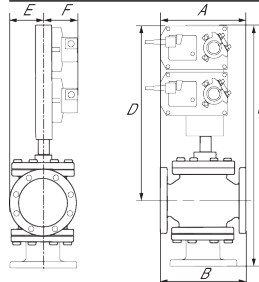

A	B	C	D	E	F	Number of Bolt Holes
12.2" [310]	10.0" [254]	30.5" [775]	22.5" [572]	3.7" [95]	5.3" [135]	4

AVKB, AVKX

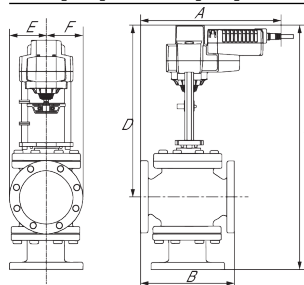

A	B	C	D	E	F	Number of Bolt Holes
13.1" [332]	10.0" [254]	27.0" [686]	19.0" [483]	3.9" [100]	3.9" [100]	4

AFB, AFX

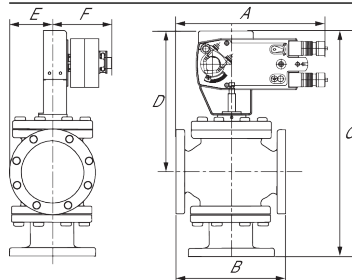

A	B	C	D	E	F	Number of Bolt Holes
12.2" [310]	10.0" [254]	25.6" [650]	17.5" [445]	3.7" [95]	5.3" [135]	4

2\*AFB, 2\*AFX

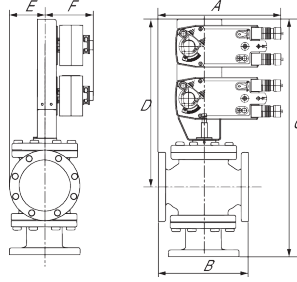

A	B	C	D	E	F	Number of Bolt Holes
12.2" [310]	10.0" [254]	30.5" [775]	22.5" [572]	3.7" [95]	5.3" [135]	4



5-year warranty



Technical data

<b>Electrical data</b>	Nominal voltage	AC/DC 24 V
	Nominal voltage frequency	50/60 Hz
	Power consumption in operation	3.5 W
	Power consumption in rest position	0.5 W
	Transformer sizing	6 VA (class 2 power source)
	Electrical Connection	18 GA plenum cable, 3 ft [1 m], with 1/2" conduit connector, degree of protection NEMA 2 / IP54
	Overload Protection	electronic throughout full stroke
	Electrical Protection	actuators are double insulated
<b>Functional data</b>	Actuating force motor	560 lbf [2500 N]
	Input Impedance	100 kΩ (0.1 mA), 500 Ω, 1000 Ω (on/off)
	Position feedback U note	No Feedback
	Direction of motion motor	selectable with switch 0/1
	Manual override	5 mm hex crank (3/16" Allen), supplied
	Stroke	2" [50 mm]
	Running Time (Motor)	default 90 s, variable 90 or 150 s
	Running time motor variable	90 or 150 s
	Noise level, motor	60 dB(A)
Position indication	Mechanically, with pointer	
<b>Safety data</b>	Degree of protection IEC/EN	IP54
	Degree of protection NEMA/UL	NEMA 2 UL Enclosure Type 2
	Agency Listing	cULus acc. to UL60730-1A/-2-14, CAN/CSA E60730-1:02, CE acc. to 2014/30/EU and 2014/35/EU; Listed to UL 2043 - suitable for use in air plenums per Section 300.22(c) of the NEC and Section 602.2 of the IMC
	Quality Standard	ISO 9001
	Ambient temperature	-22...122°F [-30...50°C]
	Storage temperature	-40...176°F [-40...80°C]
	Ambient humidity	max. 95% r.H., non-condensing
	Servicing	maintenance-free
<b>Weight</b>	Weight	5.73 lb [2.6 kg]
<b>Materials</b>	Housing material	Die cast aluminium and plastic casing

Safety notes



- PVC W/Shld for GV w/UGLK (GM)
- Battery Back Up System for SY(7-10)-110
- 120 to 24 VAC, 40 VA transformer.
- 50% voltage divider kit (resistors with wires).
- PC Tool computer programming interface, serial port.

**Electrical installation**

**INSTALLATION NOTES**

Actuators may be connected in parallel. Power consumption and input impedance must be observed.

Actuators may also be powered by 24 VDC.

Actuators with plenum cable do not have numbers; use color codes instead.

Meets cULus requirements without the need of an electrical ground connection.

**Warning! Live Electrical Components!**

During installation, testing, servicing and troubleshooting of this product, it may be necessary to work with live electrical components. Have a qualified licensed electrician or other individual who has been properly trained in handling live electrical components perform these tasks. Failure to follow all electrical safety precautions when exposed to live electrical components could result in death or serious injury.

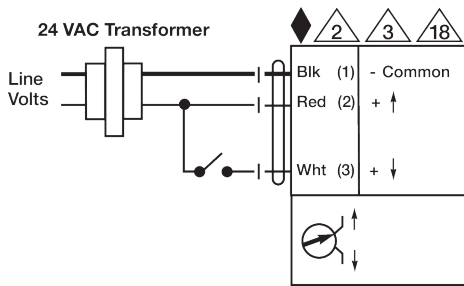

On/Off

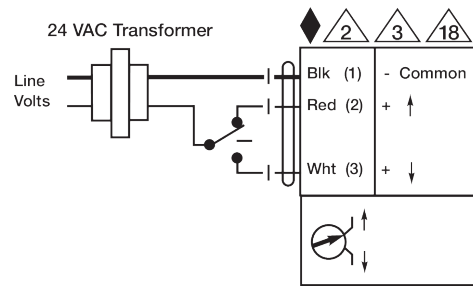

Floating Point

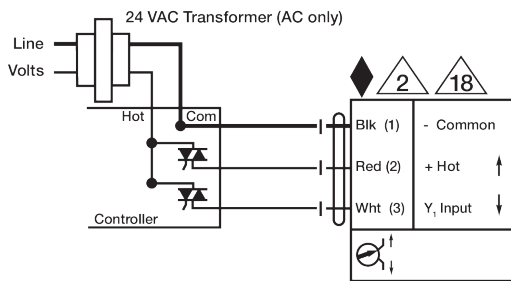

Triac Source

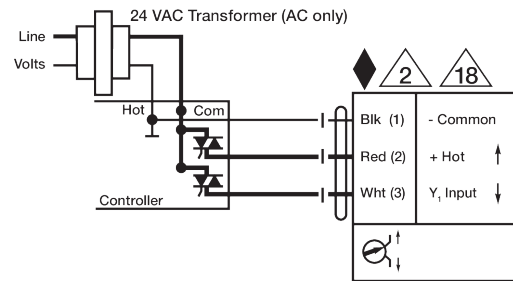

Triac Sink