

Basic Non Fail-Safe modulating actuator for controlling dampers in typical commercial HVAC applications.

- Torque motor 45 in-lb [5 Nm]
- Nominal voltage AC/DC 24 V
- Control modulating
- Position feedback 2...10 V



5-year warranty



Technical data

Electrical data	Nominal voltage	AC/DC 24 V	
	Nominal voltage frequency	50/60 Hz	
	Nominal voltage range	AC 19.2...28.8 V / DC 21.6...28.8 V	
	Power consumption in operation	1.5 W	
	Power consumption in rest position	0.4 W	
	Transformer sizing	3 VA	
	Electrical Connection	Screw terminal (for 26 to 14 GA wire)	
	Overload Protection	electronic throughout 0...95° rotation	
Functional data	Torque motor	45 in-lb [5 Nm]	
	Operating range Y	2...10 V	
	Operating range Y note	4...20 mA w/ ZG-R01 (500 Ω, 1/4 W resistor)	
	Input impedance	100 kΩ for 2...10 V (0.1 mA), 500 Ω for 4...20 mA	
	Position feedback U	2...10 V	
	Position feedback U note	Max. 0.5 mA	
	Direction of motion motor	selectable with switch 0/1	
	Manual override	external push button	
	Angle of rotation	Max. 95°	
	Angle of rotation note	adjustable with mechanical stop	
	Running Time (Motor)	35 s / 90°	
	Running time motor note	constant, independent of load	
	Noise level, motor	45 dB(A)	
Position indication	Mechanical, 30...65 mm stroke		
Safety data	Power source UL	Class 2 Supply	
	Degree of protection IEC/EN	IP20	
	Degree of protection NEMA/UL	NEMA 1	
	Enclosure	UL Enclosure Type 1	
	Agency Listing	cULus acc. to UL60730-1A/-2-14, CAN/CSA E60730-1:02 CE acc. to 2014/30/EU and 2014/35/EU	
	Quality Standard	ISO 9001	
	UL 2043 Compliant	Suitable for use in air plenums per Section 300.22(C) of the NEC and Section 602 of the IMC	
	Ambient humidity	Max. 95% RH, non-condensing	
	Ambient temperature	-22...122°F [-30...50°C]	
	Storage temperature	-40...176°F [-40...80°C]	
	Servicing	maintenance-free	
	Weight	Weight	100 lb [0.45 kg]
		Materials	Housing material

Footnotes †Rated Impulse Voltage 800V, Type action 1, Control Pollution Degree 3.

Product features

Application For proportional modulation of dampers in HVAC systems. Actuator sizing should be done in accordance with the damper manufacturer's specifications. The actuator is mounted directly to a damper shaft from 1/4" up to 5/8" in diameter by means of its universal clamp. Shafts up to 3/4" diameter can be accommodated by an accessory clamp. The actuator operates in response to a 2...10 V, or with the addition of a 500 Ω resistor, a 4...20 mA control input from an electronic controller or positioner. A 2...10 V feedback signal is provided for position indication or primary/secondary operation.

Operation The actuator is not provided with and does not require any limit switches, but is electronically protected against overload. The anti-rotation strap supplied with the actuator will prevent lateral movement.

The LMB series provides 95° of rotation and a visual indicator indicates position of the actuator. When reaching the damper or actuator end position, the actuator automatically stops. The gears can be manually disengaged with a button on the actuator cover.

The LMCB24-SR... actuators use a sensorless brushless DC motor, which is controlled by an Application Specific Integrated Circuit (ASIC). The ASIC monitors and controls the actuator's rotation and provides a digital rotation sensing (DRS) function to prevent damage to the actuator in a stall condition. Power consumption is reduced in holding mode.







Add-on auxiliary switches or feedback potentiometers are easily fastened directly onto the actuator body for signaling and switching functions.

Typical specification Proportional control damper actuators shall be electronic direct-coupled type, which require no crank arm and linkage and be capable of direct mounting to a shaft from 1/4" to 5/8". Shafts up to 3/4" diameter can be accommodate with an accessory clamp. Actuators must provide proportional damper control in response to a 2 to 10 VDC or, with the addition of a 500 Ω resistor, a 4 to 20 mA control input from an electronic controller or positioner. Actuators shall have brushless DC motor technology and be protected from overload at all angles of rotation. Actuators shall have reversing switch and manual override on the cover. If required, actuator will be provided with screw terminal strip for electrical connections (LMCB24-SR-T). Run time shall be constant and independent of torque. A 2 to 10 VDC feedback signal shall be provided for position indication. Actuators shall be cULus listed, have a 5-year warranty, and be manufactured under ISO 9001 International Quality Control Standards. Actuators shall be as manufactured by Belimo.

Accessories

Electrical accessories	Description	Type
	Battery backup system, for non-spring return models	NSV24 US
	Battery, 12 V, 1.2 Ah (two required)	NSV-BAT
	Feedback potentiometer 140 Ω add-on, grey	P140A GR
	Feedback potentiometer 500 Ω add-on, grey	P500A GR
	Feedback potentiometer 1 kΩ add-on, grey	P1000A GR
	Feedback potentiometer 2.8 kΩ add-on, grey	P2800A GR
	Feedback potentiometer 5 kΩ add-on, grey	P5000A GR
	Feedback potentiometer 10 kΩ add-on, grey	P10000A GR
	Auxiliary switch 1 x SPDT add-on	S1A
	Auxiliary switch 2 x SPDT add-on	S2A

Electrical installation

-  Provide overload protection and disconnect as required.
-  Actuators may also be powered by DC 24 V.
-  Only connect common to negative (-) leg of control circuits.
-  A 500 Ω resistor (ZG-R01) converts the 4...20 mA control signal to 2...10 V.
-  Actuators may be connected in parallel if not mechanically linked. Power consumption and input impedance must be observed.
-  Actuators are provided with a numbered screw terminal strip instead of a cable.

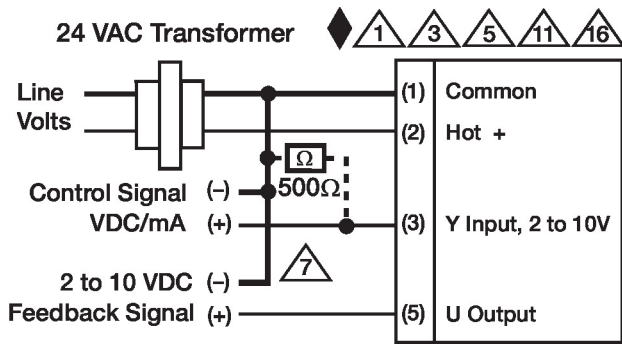

2...10 V / 4...20 mA Control

Dimensions

