

B6400VB-350, 4", V Ball Control Valve

Carbon Steel Body, Hardened Chrome Plated, Stainless Steel Ball and Stem



Technical Data

Service	chilled or hot water, up to 60% glycol, steam
Flow Characteristic	equal percentage
Controllable Flow Range	75°
Size [mm]	4" [100]
End Fitting	NPT female ends (1" to 2"); ISO flange (3" to 6")
Body	WCC Grade Carbon steel
Ball	stainless steel
Stem	stainless steel
Stem Packing	spring loaded Teflon® V-ring
Seat	Teflon®
Body Pressure Rating [psi]	ASME/ANSI Class 150
Max Inlet Pressure (Steam)	200 psi
Media Temperature Range (Water)	-22°F to 380°F [-30°C to 193°C]
Media Temperature Range (Steam)	-22°F to 380°F [-30°C to 193°C]
Maximum Differential Pressure (Steam)	100 psi
Max Differential Pressure (Water)	150 psi
Maximum Differential Pressure Steam (Rotary Actuator)	100 psi
Close-Off Pressure	150 psi
Close-Off Pressure (Steam)	200 psi
Rangeability	300:1
Cv	350
Weight	57.3 lb [26 kg]
Leakage	ANSI Class IV
Servicing	Repack/Rebuild kits available

Flow Pattern

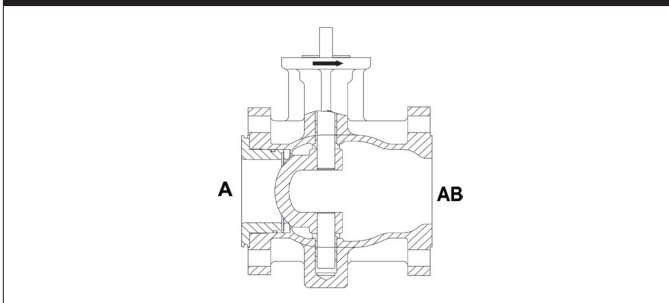

Application

Water-side control of air handling apparatus in ventilation and air-conditioning system.
 Water/Steam control in heating systems.
 300:1 rangeability.
 The dimensions and drilling of end flanges conform to the American cast iron flange standard, Class 150 (ANSI B16.1).

Product Features

Fast quarter turn open or closed operation, Stainless steel ball and stem,
 Positive shut-off, Two piece body construction

Suitable Actuators

	Non-Spring	Spring	Electronic Fail-Safe
B6400VB-350	SY2, GMB(X)	EFB(X)	GKB(X)

Dimensions (Inches [mm])

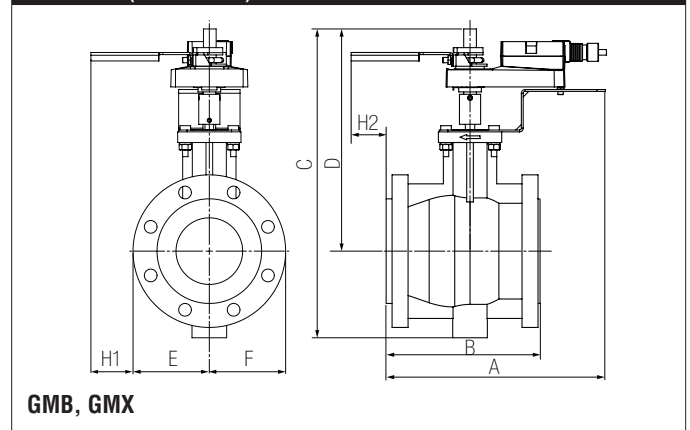

A	B	C	D	E	F	H1	H2
12.6" [320]	9" [229]	18.23" [463]	13.13" [334]	4.5" [114]	0.75" [20]	0.75" [20]	0.5" [15]

Date created, 10/12/2016 - Subject to change. © Belimo Aircontrols (USA), Inc.

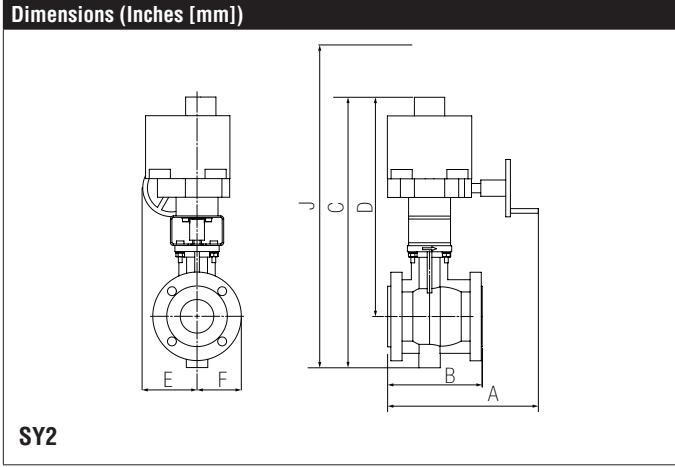

A	B	C	D	E	F	J
14.37" [365]	9" [229]	24.71" [628]	19.61" [498]	5.15" [131]	4.5" [114]	32.21" [818]

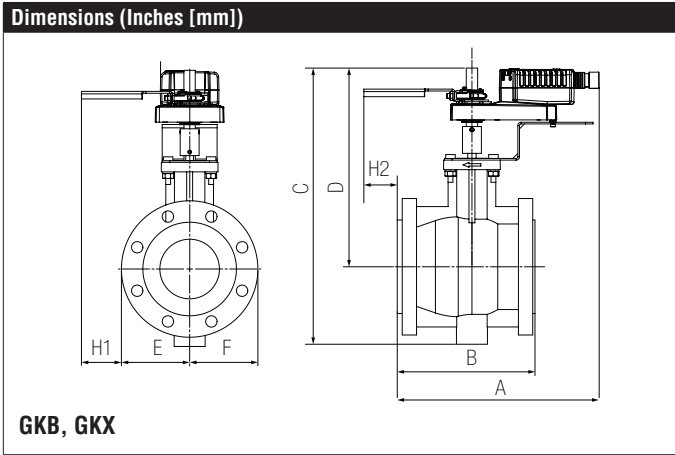

A	B	C	D	E	F	H1	H2
13.16" [334]	9" [229]	18.23" [463]	13.13" [334]	4.5" [114]	4.5" [114]	1.18" [30]	0.5" [15]

B6400VB-350, 4", V Ball Control Valve

Carbon Steel Body, Hardened Chrome Plated, Stainless Steel Ball and Stem



Dimensions (Inches [mm])

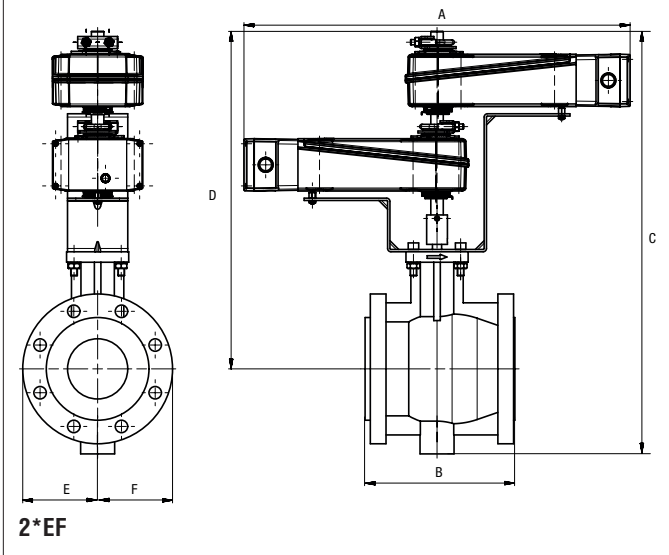

A	B	C	D	E	F
23.08" [586.2]	9.00" [229]	22.5" [571]	17.85" [453]	4.5" [114]	4.5" [114]

Date created, 10/12/2016 - Subject to change. © Belimo Aircontrols (USA), Inc.

SY2-230MFT

Modulating, Non-Spring Return, 230 V, for 2 to 10VDC or 4 to 20 mA



Application

SY Series actuators are fractional horsepower devices, and utilize full-wave power supplies. Observe wire sizing and transformer sizing requirements. Proportional models CANNOT be connected to Belimo direct coupled (AF, AM, GM...etc) actuator power supplies or any type of half-wave device. You MUST use a separate, dedicated transformer or power supply to power the SY actuator. Please do not connect other automation equipment to the dedicated SY supply source. You MUST use four wires (plus a ground) to control a proportional control SY actuator (See SY Wiring Section).

Technical Data	
Power Supply	230 VAC \pm 10%, 50/60 Hz
Power Consumption Running	78 W
Transformer Sizing	92 VA (class 2 power source)
Electrical Connection	terminal block
Overload Protection	thermally protected 135°C cut-out
Operating Range Y	2 to 10 VDC, 4 to 20 mA w/ ZG-R01 (500 Ω , 1/4 W resistor) between 0% and 100%
Input Impedance	100 k Ω
Feedback Output U	2 to 10 VDC
Angle of Rotation	90°
Torque	801 in-lbs [90 Nm] minimum
Duty cycle	75%
Direction of Rotation (Motor)	reversible with built-in switch
Position Indication	top mounted domed indicator
Manual Override	hand wheel
Running Time (Motor)	16 sec
Internal Humidity Control	resistive heating element
Ambient Humidity	5 to 100% RH (UL Type 4)
Ambient Temperature Range	-22°F to 150°F [-30°C to 65°C]
Storage Temperature Range	-40°F to 176°F [-40°C to 80°C]
Housing	NEMA 4X, IP66/67, UL Enclosure Type 4
Housing Material	die cast aluminum alloy
Gear Train	high alloy steel gear sets, self locking
Agency Listings†	ISO, CE, cCSAus
Noise Level (Motor)	<45 dB (A)
Servicing	maintenance free
Quality Standard	ISO 9001
Weight	24.2 lb [11 kg]
Auxiliary Switch	2 x SPDT 3A resistive (0.5A inductive) @ 250 VAC, one set at +10° and one set at 85°

Wiring Diagrams

INSTALLATION NOTES

- 60** Do not change sensitivity or dip switch setting with power applied.
- 61** Power supply Common/Neutral and Control Signal “-” wiring to a common is prohibited. Terminals 4 and 6 need to be wired separately.
- 62** Isolation relays must be used in parallel connection of multiple actuators using a common control signal inputs. The relays should be DPDT.
- 63** Isolation relays are required in parallel applications. The reason parallel applications need isolation relays is that the motor uses two sets of windings, one for each direction. When one is energized to turn the actuator in a specific direction a voltage is generated in the other due to the magnetic field created from the first. It's called back EMF. This is not an issue with one actuator because the voltage generated in the second winding isn't connected to anything so there is no flow. On parallel applications without isolation, this EMF voltage energizes the winding it is connected to on the other actuators in the system, the actuators are trying to turn in both directions at once. The EMF voltage is always less than the supply voltage due to the resistance of the windings, so while the actuator still turns in the commanded direction, the drag from the other reduces the torque output and causes overheating.

WARNING! LIVE ELECTRICAL COMPONENTS!
 During installation, testing, servicing and troubleshooting of this product, it may be necessary to work with live electrical components. Have a qualified licensed electrician or other individual who has been properly trained in handling live electrical components perform these tasks. Failure to follow all electrical safety precautions when exposed to live electrical components could result in death or serious injury.

