

P2050B045, 1/2", Pressure Independent Valve

Chrome Plated Brass Ball and Brass Stem, NPT Female Ends



Technical Data	
Service	chilled, hot water, up to 60% glycol
Flow Characteristic	equal percentage
Controllable Flow Range	75°
Size [mm]	0.5" [15]
End Fitting	NPT female ends
Body	forged brass, nickel plated
Ball	chrome plated brass
Stem	nickel plated brass
Seat	Teflon® PTFE
Seat O-ring	EPDM (lubricated)
Characterized Disc	Brass
Packing	EPDM
Diaphragm	Nomex reinforced Silicone
Regulator Components	stainless steel / brass / Nitrile
Body Pressure Rating [psi]	600
Media Temperature Range (Water)	0°F to 212°F [-18°C to 100°C]
Differential Pressure Range	5 to 50 psi
Close-Off Pressure	200 psi
Rangeability	100:1
Valve Accuracy	± 5%*
Weight	2.2 lb [1 kg]
GPM	4.5
Leakage	ANSI Class IV (0.01% of rated valve capacity at 50 psi differential)

*See page 3 of the PICCV technical documentation for details.

Application

The Pressure Independent Characterized Control Valve is typically used in air handling units on heating and cooling coils, and fan coil unit heating or cooling coils. Some other common applications include unit ventilators and VAV reheat coils. This valve is suitable for use in a hydronic system with constant or variable flow. This valve is designed with MFT functionality which facilitates the use of various control input.

Suitable Actuators

	Non-Spring	Spring
P2050B045	LR, LRC	TFR, LF

Dimensions (Inches [mm])

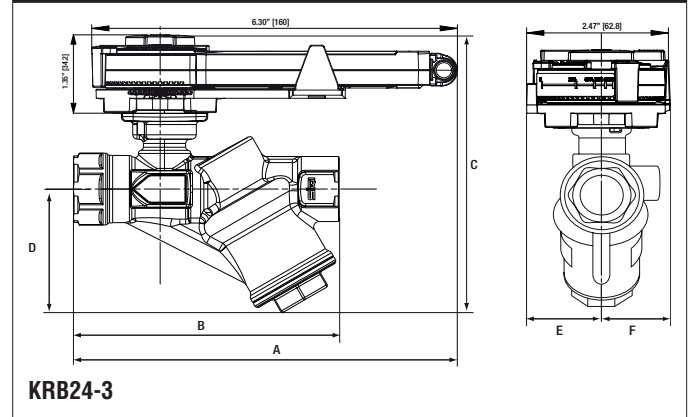

A	B	C	D	E	F
6.56" [167]	4.47" [114]	5.09" [129]	2.34" [59.4]	1.33" [34]	1.25" [32]

Date created, 03/10/2017 - Subject to change. © Belimo Aircontrols (USA), Inc.

P2050B045, 1/2", Pressure Independent Valve

Chrome Plated Brass Ball and Brass Stem, NPT Female Ends

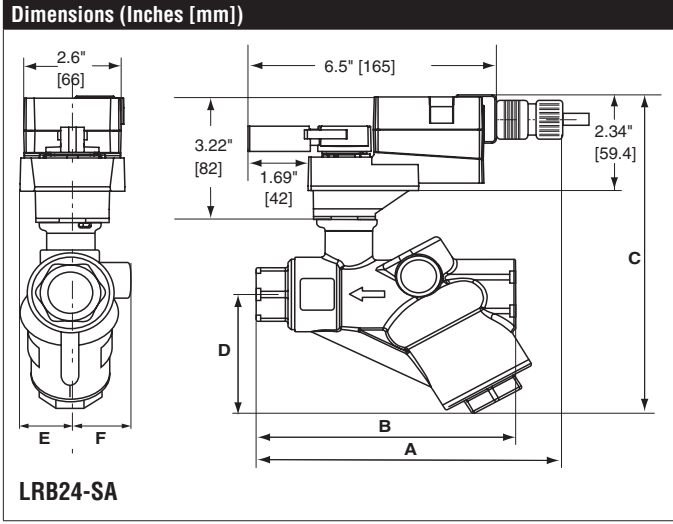

A	B	C	D	E	F
7.68" [195]	4.47" [114]	7.13" [181]	2.34" [59.4]	1.48" [38]	

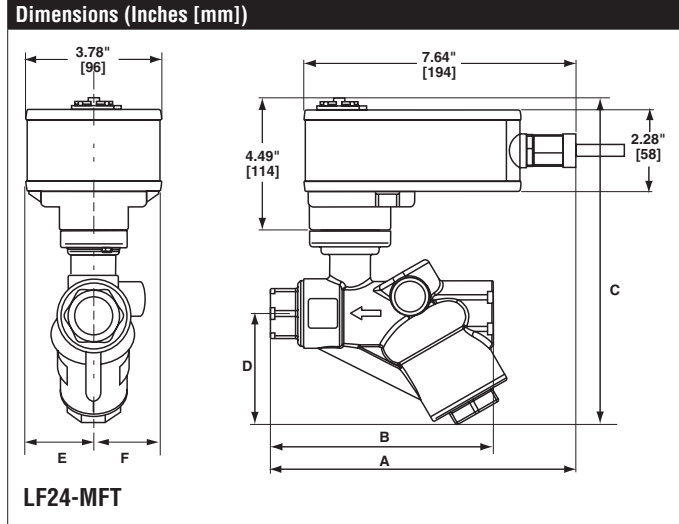

A	B	C	D	E	F
8.1" [206]	4.47" [114]	8.54" [217]	2.34" [59.4]	1.89" [48]	

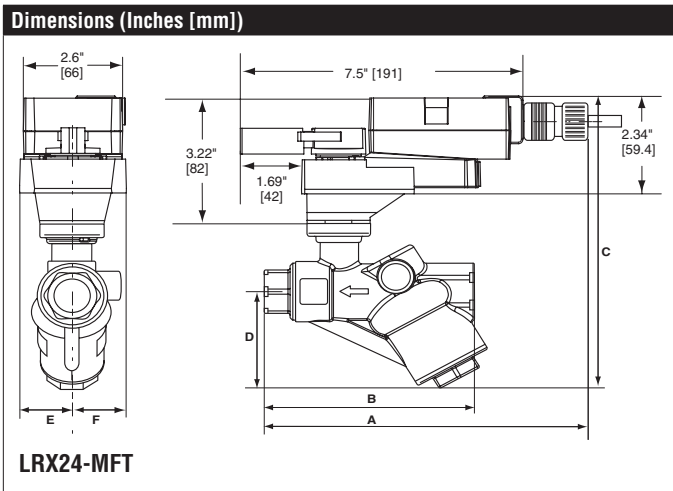

A	B	C	D	E	F
8.68" [220]	4.47" [114]	7.13" [181]	2.34" [59.4]	1.48" [38]	

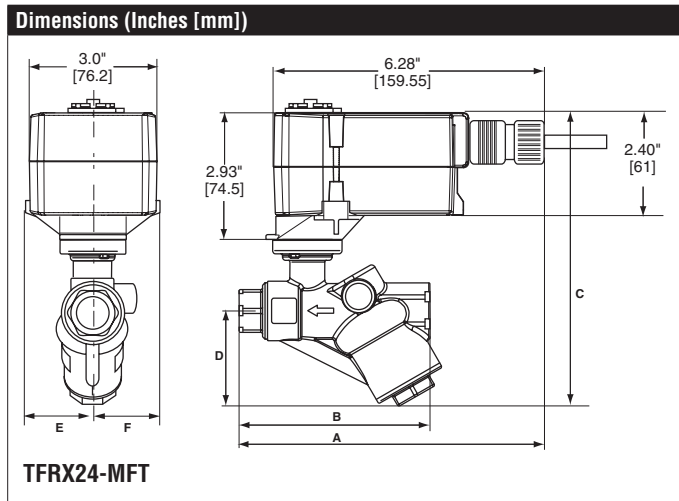

A	B	C	D	E	F
7.1" [180]	4.47" [114]	6.98" [177]	2.34" [59.4]	1.5" [38]	

P2050B045, 1/2", Pressure Independent Valve

Chrome Plated Brass Ball and Brass Stem, NPT Female Ends

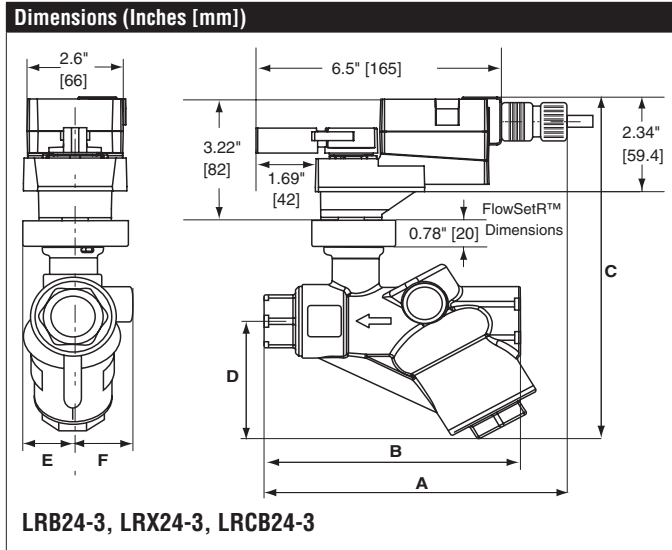

A	B	C	D	E	F
7.68" [195]	4.47" [114]	7.91" [201]	2.34" [59.4]	1.48" [38]	

Date created, 03/10/2017 - Subject to change. © Belimo Aircontrols (USA), Inc.

LF24-MFT US, Valve Actuator

Modulating, Spring Return, Multi-Function Technology®



Technical Data	
Power Supply	24 VAC ± 20%, 50/60 Hz, 24 VDC ± 10%
Power Consumption Running	2.5 W
Power Consumption Holding	1 W
Transformer Sizing	5 VA (class 2 power source)
Electrical Connection	3ft [1m], 18 GA appliance cable with 1/2" conduit connector
Overload Protection	electronic throughout 0° to 95° rotation
Operating Range Y	2 to 10 VDC, 4 to 20 mA w/ ZG-R01 (500 Ω, 1/4 W resistor), variable (VDC, floating point, on/off)
Input Impedance	100 k Ω for 2 to 10 VDC (0.1 mA), 500 Ω for 4 to 20 mA, 1500 Ω for PWM, floating point and On/Off
Feedback Output U	2 to 10 VDC, 0.5 mA max, VDC variable
Angle of Rotation	90°
Direction of Rotation (Motor)	reversible with built-in switch
Direction of Rotation (Fail-Safe)	reversible with CW/CCW mounting
Position Indication	visual indicator, 0° to 95° (0° is full spring return position)
Running Time (Motor)	150 sec (default), variable (75 to 300 sec)
Running Time (Fail-Safe)	<25 sec @ -4°F to 122°F [-20°C to 50°C], < 60 sec @ -22°F [-30°C]
Ambient Temperature Range	-22°F to 122°F [-30°C to 50°C]
Storage Temperature Range	-40°F to 176°F [-40°C to 80°C]
Housing	NEMA 2, IP54
Agency Listings†	cULus acc. To UL 873 and CAN/CSA C22.2 No. 24-93
Noise Level (Motor)	<50 dB (A)
Noise Level (Fail-Safe)	<62 dB (A)
Servicing	maintenance free
Quality Standard	ISO 9001

†Rated Impulse Voltage 800V, Type of action 1.AA, Control Pollution Degree 3
 *Variable when configured with MFT options.

Date created, 09/05/2017 - Subject to change. © Belimo Aircontrols (USA), Inc.

Wiring Diagrams

INSTALLATION NOTES

- Actuators with appliance cables are numbered.
- Provide overload protection and disconnect as required.
- Actuators may be connected in parallel. Power consumption and input impedance must be observed.
- Apply only AC line voltage or only UL-Class 2 voltage to the terminals of auxiliary switches. Mixed or combined operation of line voltage/safety extra low voltage is not allowed.
- Actuators may also be powered by 24 VDC.
- Two built-in auxiliary switches (2x SPDT), for end position indication, interlock control, fan startup, etc.
- Only connect common to negative (-) leg of control circuits.
- A 500 Ω resistor (ZG-R01) converts the 4 to 20 mA control signal to 10 VDC.
- Control signal may be pulsed from either the Hot (Source) or Common (Sink) 24 VAC line.
- For triac sink the Common connection from the actuator must be connected to the Hot connection of the controller. Position feedback cannot be used with a triac sink controller; the actuator internal common reference is not compatible.
- Actuators may be connected in parallel if not mechanically linked. Power consumption and input impedance must be observed.
- IN4004 or IN4007 diode. (IN4007 supplied, Belimo part number 40155).
- Meets cULus requirements without the need of an electrical ground connection.
- Actuators are provided with color coded wires. Wire numbers are provided for reference.
- WARNING! LIVE ELECTRICAL COMPONENTS!** During installation, testing, servicing and troubleshooting of this product, it may be necessary to work with live electrical components. Have a qualified licensed electrician or other individual who has been properly trained in handling live electrical components perform these tasks. Failure to follow all electrical safety precautions when exposed to live electrical components could result in death or serious injury.

On/Off

Blk (1)	Common
Red (2)	+ Hot
Wht (3)	Y Input
Wht (5)	U Output

Floating Point

Blk (1)	Common
Red (2)	+ Hot
Wht (3)	Y Input
Wht (5)	U Output

VDC/mA Control

Blk (1)	Common
Red (2)	+ Hot
Wht (3)	Y Input
Wht (5)	U Output

PWM Control

Blk (1)	Common
Red (2)	+ Hot
Wht (3)	Y Input
Wht (5)	U Output

Override Control

Functions	a	b	c
Min	0% ←	↘	↘
Mid	50% ←	↘	↘
Max	100% ←	↘	↘
Normal	Control mode acc. to Y	↘	↘