

P2125S-222, 1-1/4", Electronic Pressure Independent Valve

Stainless Steel Ball and Stem, Female NPT Ends



Technical Data	
Service	chilled or hot water, up to 60% glycol max (open loop/steam not allowed)
Flow Characteristic	equal percentage or linear
Size [mm]	1.25" [32]
End Fitting	NPT female ends
Body	forged brass, nickel plated
Sensor Housing	forged brass, nickel plated
Ball	stainless steel
Stem	stainless steel
Seat	Teflon® PTFE
Seat O-ring	EPDM
Characterized Disc	TEFZEL® or stainless steel
Body Pressure Rating [psi]	360
Media Temperature Range (Water)	14°F to 250°F [-10°C to 120°C]
Differential Pressure Range	5 to 50 psid, 1 to 50 psid (with flow reduction. See chart.), or 8 to 50 psid (with flow increase. See chart.)
Close-Off Pressure	200 psi
Inlet Length to Meet Specified Measurement Accuracy	5X nominal pipe size (NPS)
Ambient Humidity	<95% RH non-condensing
Flow Measurement Tolerance	±2%*
Flow Control Tolerance	±5%
Flow Measurement Repeatability	±0.5%
Sensor Technology	ultrasonic with glycol and temperature compensation
Rangeability	100:1
Power Supply for the Flow Sensor	sensor is powered by the actuator
Weight	6.2 lb [2.8 kg]
GPM	22.2
Leakage	0%

*All flow tolerances are at 68°F (20°C) & water.

Application

Water-side control of heating and cooling systems for AHUs and water coils. Equal Percentage/ Linear: heating and cooling applications.

Operation

The Electronic Pressure Independent Control Valve is a two-way valve that maintains constant flow regardless of pressure variations in the system.

Product Features

Provides constant flow regardless of pressure variations in the system. Maximizes chiller P, preventing energizing additional chillers due to low T. Simplified valve sizing and selection, no Cv calculations required.

Suitable Actuators

	Non-Spring	Electronic Fail-Safe
P2125S-222	NR	AKRX

Dimensions (Inches [mm])

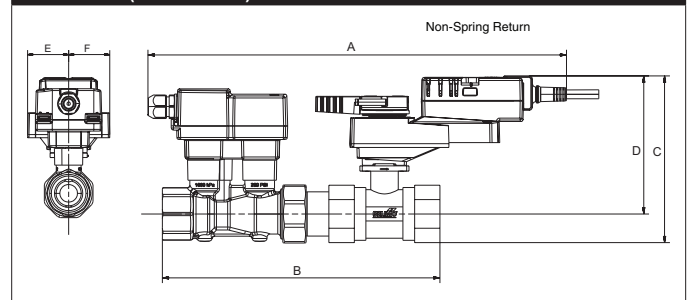

A	B	C	D	E	F
16.37" [416]	10" [254]	6.08" [154]	5.16" [131]	1.73" [44]	

Date created, 10/03/2017 - Subject to change. © Belimo Aircontrols (USA), Inc.

P2125S-222, 1-1/4", Electronic Pressure Independent Valve

Stainless Steel Ball and Stem, Female NPT Ends

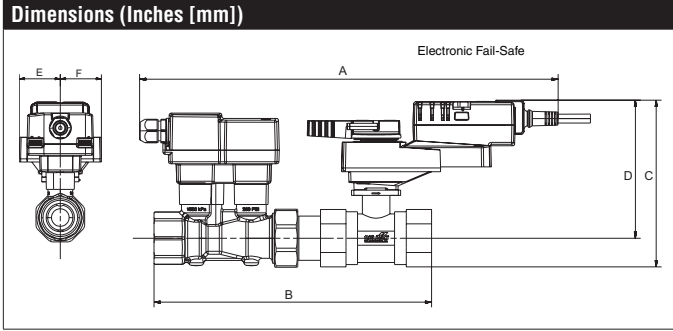

A	B	C	D	E	F
17.9" [454]	10" [254]	8.18" [208]	7.29" [185]	1.89" [48]	

NRX24-EP

Modulating, Non-Spring Return, 24 V, Multi-Function Technology®

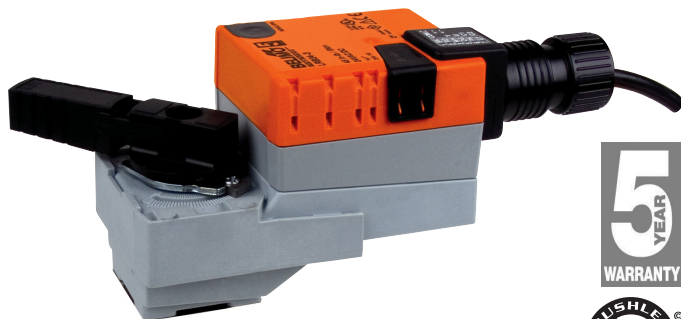

Technical Data	
Power Supply	24 VAC ± 20%, 50/60 Hz, 24 VDC ± 10%
Power Consumption Running	4.5 W
Transformer Sizing	7 VA (class 2 power source)
Electrical Connection	3ft [1m], 18 GA plenum cable with 1/2" conduit connector
Overload Protection	electronic throughout 0° to 90° rotation
Operating Range Y	2 to 10 VDC, 4 to 20 mA w/ ZG-R01 (500 Ω, 1/4 W resistor)
Input Impedance	100 kΩ (0.1 mA), 500 Ω
Feedback Output U	2 to 10 VDC
Angle of Rotation	90°
Torque	90 in-lbs [10 Nm] minimum
Direction of Rotation (Motor)	reversible with pc tool
Position Indication	integrated into handle
Manual Override	external push button
Running Time (Motor)	90 sec
Ambient Humidity	5 to 95% RH non condensing (EN 60730-1)
Ambient Temperature Range	-22°F to 122°F [-30°C to 50°C]
Storage Temperature Range	-40°F to 176°F [-40°C to 80°C]
Housing	NEMA 2, IP54
Housing Material	UL94-5VA
Agency Listings†	cULus acc. to UL60730-1A/-2-14, CAN/CSA E60730-1:02, CE acc. to 2004/108/EC and 2006/95/EC
Noise Level (Motor)	max. 35 dB (A)
Servicing	maintenance free
Quality Standard	ISO 9001
Weight	1.5 lb [0.7 kg]

†Rated Impulse Voltage 800V, Type of action 1.AA, Control Pollution Degree 3

Wiring Diagrams
INSTALLATION NOTES

- Provide overload protection and disconnect as required.
- Actuators may be connected in parallel. Power consumption and input impedance must be observed.
- Actuators may also be powered by 24 VDC.
- Actuators are provided with color coded wires. Wire numbers are provided for reference.
- Actuators are provided with a numbered screw terminal strip instead of a cable.
- IN4004 or IN4007 diode required
- Meets cULus requirements without the need of an electrical ground connection.

WARNING! LIVE ELECTRICAL COMPONENTS!
 During installation, testing, servicing and troubleshooting of this product, it may be necessary to work with live electrical components. Have a qualified licensed electrician or other individual who has been properly trained in handling live electrical components perform these tasks. Failure to follow all electrical safety precautions when exposed to live electrical components could result in death or serious injury.

