

P2200S-850, 2", Electronic Pressure Independent Valve

Stainless Steel Ball and Stem, Female NPT Ends

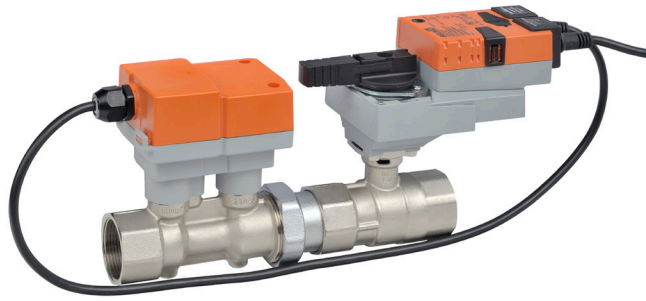

Technical Data	
Service	chilled or hot water, up to 60% glycol max (open loop/steam not allowed)
Flow Characteristic	equal percentage or linear
Size [mm]	2" [50]
End Fitting	NPT female ends
Body	forged brass, nickel plated
Sensor Housing	forged brass, nickel plated
Ball	stainless steel
Stem	stainless steel
Seat	Teflon® PTFE
Seat O-ring	EPDM
Characterized Disc	TEFZEL® or stainless steel
Body Pressure Rating [psi]	360
Media Temperature Range (Water)	39°F to 250°F [4°C to 120°C]
Differential Pressure Range	5 to 50 psid, 1 to 50 psid (with flow reduction. See chart.), or 8 to 50 psid (with flow increase. See chart.)
Close-Off Pressure	200 psi
Inlet Length to Meet Specified Measurement Accuracy	5X nominal pipe size (NPS)
Ambient Humidity	<95% RH non-condensing
Flow Measurement Tolerance	±2%*
Flow Control Tolerance	±5%
Flow Measurement Repeatability	±0.5%
Sensor Technology	ultrasonic with glycol and temperature compensation
Rangeability	100:1
Power Supply for the Flow Sensor	sensor is powered by the actuator
Weight	9.7 lb [4.4 kg]
GPM	85
Leakage	0%

*All flow tolerances are at 68°F (20°C) & water.

Application

Water-side control of heating and cooling systems for AHUs and water coils. Equal Percentage/ Linear: heating and cooling applications.

Operation

The Electronic Pressure Independent Control Valve is a two-way valve that maintains constant flow regardless of pressure variations in the system.

Product Features

Provides constant flow regardless of pressure variations in the system. Maximizes chiller P, preventing energizing additional chillers due to low T. Simplified valve sizing and selection, no Cv calculations required.

Suitable Actuators

	Non-Spring	Electronic Fail-Safe
P2200S-850	ARB(X)	AKRX

Dimensions (Inches [mm])

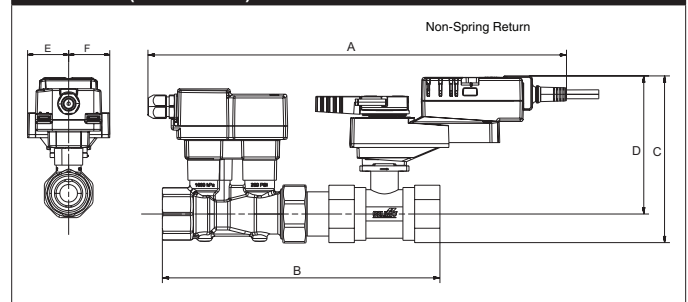

A	B	C	D	E	F
17.04" [433]	11.18" [284]	6.89" [175]	5.59" [142]	1.73" [44]	

Date created, 12/01/2017 - Subject to change. © Belimo Aircontrols (USA), Inc.

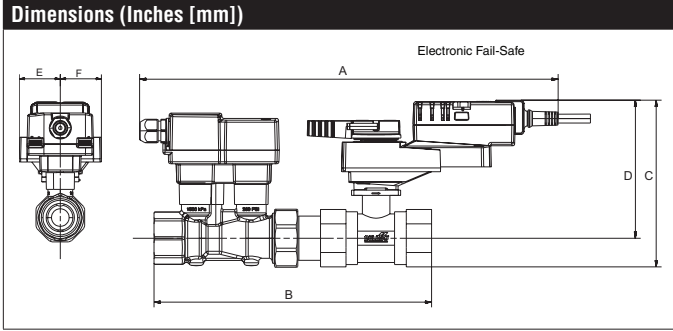

A	B	C	D	E	F
18.23" [463]	11.18" [284]	9.04" [229]	7.79" [198]	1.89" [48]	

ARX24-EP-MOD









Technical Data	
Power Supply	24 VAC, ±20%, 50/60 Hz, 24 VDC, ±10%
Power Consumption Running	4.5 W
Transformer Sizing	7 VA (class 2 power source)
Electrical Connection	3ft [1m], 18 GA plenum cable with 1/2" conduit connector
Overload Protection	electronic throughout 0° to 90° rotation
Operating Range Y	2 to 10 VDC (default) VDC variable
Input Impedance	100 kΩ (0.1 mA), 500 Ω
Feedback Output U	2 to 10 VDC (default) VDC variable
Angle of Rotation	90°
Nominal torque	Min. 180 in-lbs [20 Nm]
Direction of Rotation (Motor)	reversible with pc tool
Position Indication	integrated into handle
Manual Override	external push button
Ambient Humidity	5 to 95% RH non condensing (EN 60730-1)
Ambient Temperature Range	-22°F to 122°F [-30°C to 50°C]
Storage Temperature Range	-40°F to 176°F [-40°C to 80°C]
Housing	NEMA 2, IP54
Housing Material	UL94-5VA
Agency Listings†	cULus acc. to UL60730-1A/-2-14, CAN/CSA E60730-1:02, CE acc. to 2004/108/EC and 2006/95/EC
Noise Level (Motor)	max. 45 dB (A)
Servicing	maintenance free
Quality Standard	ISO 9001
Weight	2.6 lb [1.2 kg]
Degree of Protection IEC/EN	IP54

†Rated Impulse Voltage 800V, Type action 1, Control Pollution Degree 3.

Date created, 01/18/2018 - Subject to change. © Belimo Aircontrols (USA), Inc.

Wiring Diagrams

✂️ INSTALLATION NOTES

-  Provide overload protection and disconnect as required.
-  Actuators may be connected in parallel. Power consumption and input impedance must be observed.
-  Actuators may also be powered by 24 VDC.
-  Actuators with plenum cable do not have numbers; use color codes instead.
-  IN4004 or IN4007 diode required
-  Meets cULus requirements without the need of an electrical ground connection.

 **WARNING! LIVE ELECTRICAL COMPONENTS!**
 During installation, testing, servicing and troubleshooting of this product, it may be necessary to work with live electrical components. Have a qualified licensed electrician or other individual who has been properly trained in handling live electrical components perform these tasks. Failure to follow all electrical safety precautions when exposed to live electrical components could result in death or serious injury.

24 VAC/DC Transformer 

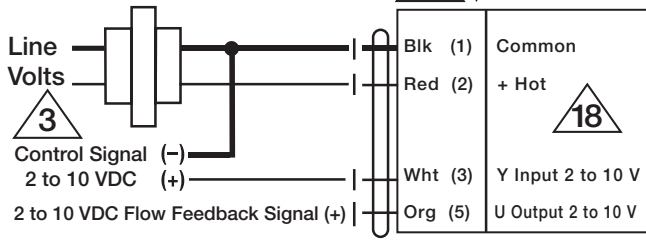

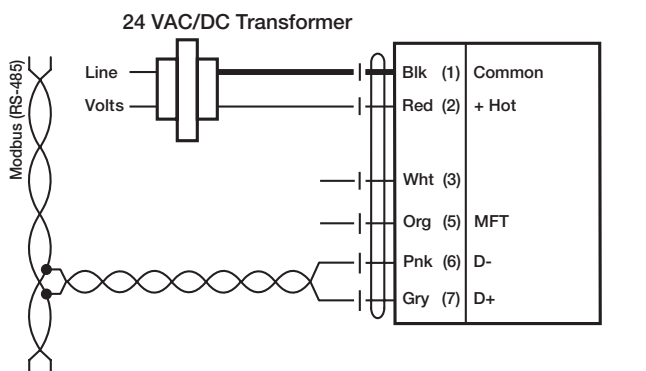

Blk (1)	Common
Red (2)	+ Hot
Wht (3)	Y Input 2 to 10 V
Org (5)	U Output 2 to 10 V

24 VAC Transformer 



Blk (1)	Common
Red (2)	+ Hot
Wht (3)	Y ₁ Input, 2 to 10 V
Org (5)	U Output, 2 to 10 V

...MFT

24 VAC Transformer 

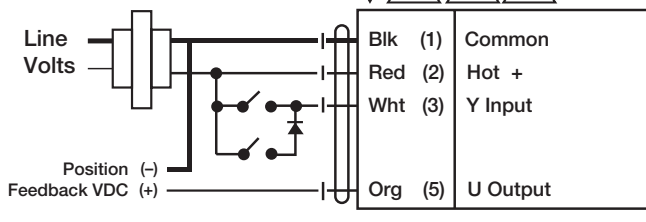

Blk (1)	Common
Red (2)	Hot +
Wht (3)	Y Input
Org (5)	U Output

24 VAC/DC Transformer

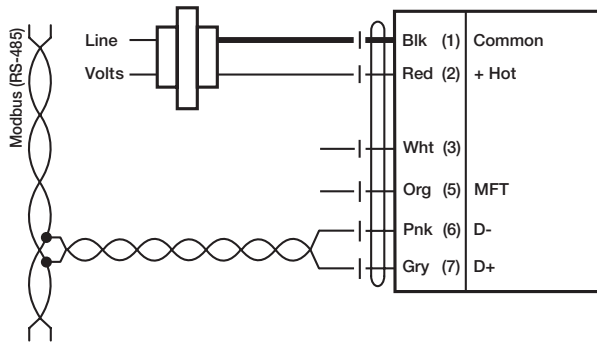

Blk (1)	Common
Red (2)	+ Hot
Wht (3)	
Org (5)	MFT
Pnk (6)	D-
Gry (7)	D+

Modbus control for Non-Spring Return

Note:
 Modbus signal assignment: Power supply and communication are not galvanically isolated.
 C₁ = D- = A Interconnect ground signal of the devices.
 C₂ = D+ = B

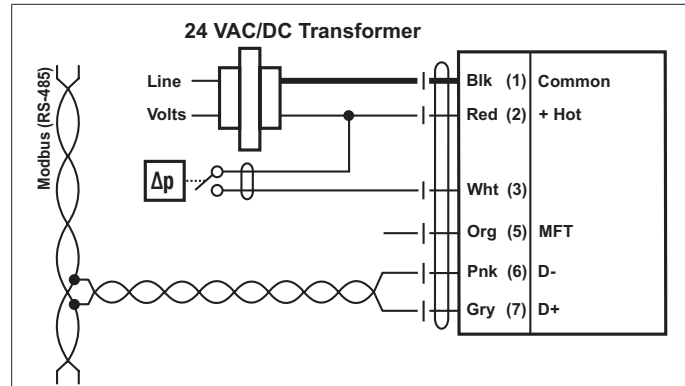

Modbus control with switching contact for Non-Spring Return

Requirements for switching contact:

The switching contact must be able to accurately switch a current of 16 mA at 24 V.

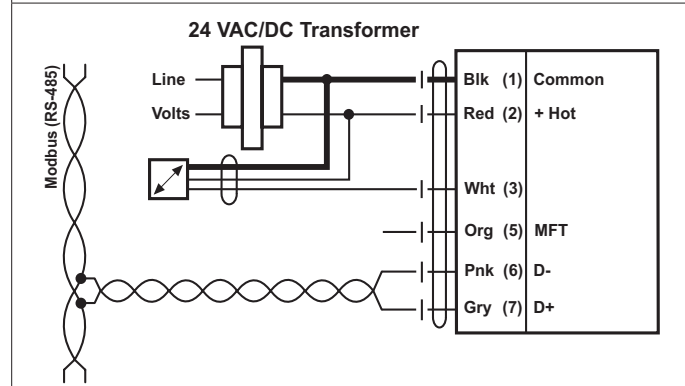

Modbus control with active sensor for Non-Spring Return

Possible input voltage range:

0...32 V (resolution 30 mV)

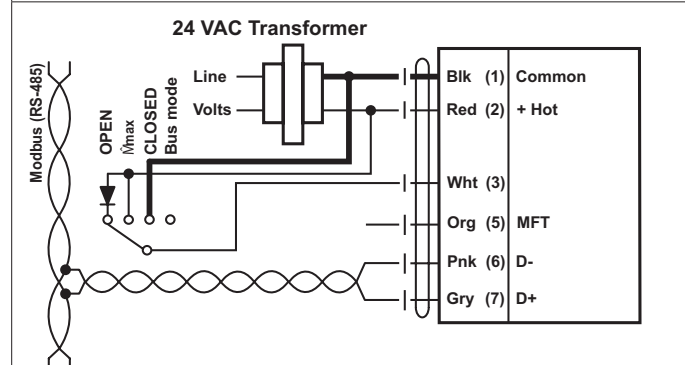

Modbus control with local override (AC only, analogue override) for Non-Spring Return

Note:

If no sensor is integrated, then connection 3 (Y) is available for the protective circuit of a local override control. Options: CLOSED, Vmax, OPEN