

P6250S-121, 2-1/2", Electronic Pressure Independent Valve

Stainless Steel Ball, ANSI 125 Flange



Technical Data	
Service	chilled or hot water, up to 60% glycol max (open loop/steam not allowed)
Flow Characteristic	equal percentage or linear
Size [mm]	2.5" [65]
End Fitting	pattern to mate with ansi 125 flange
Body	cast iron - GG25
Sensor Housing	ductile iron - GGG50
Ball	stainless steel
Stem	stainless steel
Seat	Teflon® PTFE
Seat O-ring	Viton
Characterized Disc	stainless steel
Packing	2 EPDM O-rings, lubricated
Body Pressure Rating [psi]	ANSI 125, standard class B
Media Temperature Range (Water)	14°F to 250°F [-10°C to 120°C]
Differential Pressure Range	5 to 50 psid, 1 to 50 psid (with flow reduction. See chart.), or 8 to 50 psid (with flow increase. See chart.)
Close-Off Pressure	100 psi
Inlet Length to Meet Specified Measurement Accuracy	5X nominal pipe size (NPS)
Ambient Humidity	<95% RH non-condensing
Flow Measurement Tolerance	±2% *
Flow Control Tolerance	±5%
Flow Measurement Repeatability	±0.5%
Sensor Technology	electromagnetic
Rangeability	40:1
Power Supply for the Flow Sensor	sensor is powered by the actuator
Weight	49.6 lb [22.5 kg]
GPM	121
Leakage	0%

*All flow tolerances are at 68°F (20°C) & water.

Application

Water-side control of heating and cooling systems for AHUs and water coils. Equal Percentage/ Linear: heating and cooling applications.

Operation

The Electronic Pressure Independent Control Valve is a two-way valve that maintains constant flow regardless of pressure variations in the system.

Product Features

Provides constant flow regardless of pressure variations in the system. Maximizes chiller P, preventing energizing additional chillers due to low T. Simplified valve sizing and selection, no Cv calculations required.

Suitable Actuators

	Non-Spring	Electronic Fail-Safe
P6250S-121	ARB(X)	AKRX

Dimensions (Inches [mm])

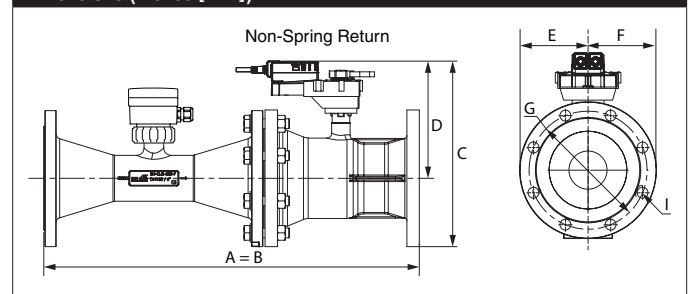

A	B	C	D	E	F	G	I
17.9" [454]		10.82" [275]	7.18" [182]	3.5" [89]		5.5" [140]	0.75" [19]

Date created, 10/03/2017 - Subject to change. © Belimo Aircontrols (USA), Inc.

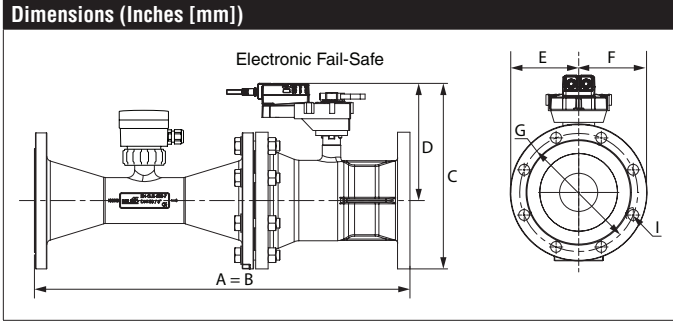

A	B	C	D	E	F
17.9" [454]		13.00" [330]	9.24" [235]	3.5" [89]	

AKRX24-PI



Technical Data	
Power Supply	24 VAC ± 20%, 50/60 Hz, 24 VDC ± 10%
Power Consumption Running	8 W
Transformer Sizing	16 VA (class 2 power source)
Electrical Connection	3ft [1m], 18 GA plenum cable with 1/2" conduit connector
Overload Protection	electronic throughout 0° to 90° rotation
Operating Range Y	2 to 10 VDC (default) VDC variable
Input Impedance	100 kΩ (0.1 mA), 500 Ω
Feedback Output U	2 to 10 VDC (default) VDC variable
Direction of Rotation (Motor)	reversible with pc tool
Direction of Rotation (Fail-Safe)	reversible with switch
Manual Override	external push button
Running Time (Motor)	90 sec
Running Time (Fail-Safe)	35 sec
Ambient Humidity	5 to 95% RH non condensing (EN 60730-1)
Ambient Temperature Range	-22°F to 122°F [-30°C to 50°C]
Storage Temperature Range	-40°F to 176°F [-40°C to 80°C]
Housing	NEMA 2, IP54, UL Enclosure Type 2
Housing Material	UL94-5VA
Agency Listings†	cULus acc. to UL60730-1A/-2-14, CAN/CSA E60730-1:02, CE acc. to 2004/108/EC and 2006/95/EC
Noise Level (Motor)	max. 45 dB (A)
Servicing	maintenance free
Quality Standard	ISO 9001
Weight	3.3 lb [1.5 kg]

In cases where the valve body is electrically isolated from the water pipe, an earth ground should be installed in order for the sensor to work properly. Earth ground can be connected directly on the sensor body. A connection point is provided on the flange of the sensor body.

†Rated Impulse Voltage 800V, Type of action 1.AA, Control Pollution Degree 3

Wiring Diagrams
INSTALLATION NOTES

- Provide overload protection and disconnect as required.
- Actuators may be connected in parallel. Power consumption and input impedance must be observed.
- Actuators may also be powered by 24 VDC.
- Actuators with plenum cable do not have numbers; use color codes instead.
- IN4004 or IN4007 diode required
- Meets cULus requirements without the need of an electrical ground connection.

WARNING! LIVE ELECTRICAL COMPONENTS!
 During installation, testing, servicing and troubleshooting of this product, it may be necessary to work with live electrical components. Have a qualified licensed electrician or other individual who has been properly trained in handling live electrical components perform these tasks. Failure to follow all electrical safety precautions when exposed to live electrical components could result in death or serious injury.

