

P6400S-210, 4", Electronic Pressure Independent Valve

Stainless Steel Ball, ANSI 125 Flange



| Technical Data | |
|---|--|
| Service | chilled or hot water, up to 60% glycol max (open loop/steam not allowed) |
| Flow Characteristic | equal percentage or linear |
| Size [mm] | 4" [100] |
| End Fitting | pattern to mate with ansi 125 flange |
| Body | cast iron - GG25 |
| Sensor Housing | ductile iron - GGG50 |
| Ball | stainless steel |
| Stem | stainless steel |
| Seat | Teflon® PTFE |
| Seat O-ring | Viton |
| Characterized Disc | stainless steel |
| Packing | 2 EPDM O-rings, lubricated |
| Body Pressure Rating [psi] | ANSI 125, standard class B |
| Media Temperature Range (Water) | 14°F to 250°F [-10°C to 120°C] |
| Differential Pressure Range | 5 to 50 psid, 1 to 50 psid (with flow reduction. See chart.), or 8 to 50 psid (with flow increase. See chart.) |
| Close-Off Pressure | 100 psi |
| Inlet Length to Meet Specified Measurement Accuracy | 5X nominal pipe size (NPS) |
| Ambient Humidity | <95% RH non-condensing |
| Flow Measurement Tolerance | ±2% * |
| Flow Control Tolerance | ±5% |
| Flow Measurement Repeatability | ±0.5% |
| Sensor Technology | electromagnetic |
| Rangeability | 40:1 |
| Power Supply for the Flow Sensor | sensor is powered by the actuator |
| Weight | 90.2 lb [40.9 kg] |
| GPM | 210 |
| Leakage | 0% |

*All flow tolerances are at 68°F (20°C) & water.

Application

Water-side control of heating and cooling systems for AHUs and water coils. Equal Percentage/ Linear: heating and cooling applications.

Operation

The Electronic Pressure Independent Control Valve is a two-way valve that maintains constant flow regardless of pressure variations in the system.

Product Features

Provides constant flow regardless of pressure variations in the system. Maximizes chiller P, preventing energizing additional chillers due to low T. Simplified valve sizing and selection, no Cv calculations required.

Suitable Actuators

| | Non-Spring | Electronic Fail-Safe |
|------------|------------|----------------------|
| P6400S-210 | GRB(X) | GKRB(X) |

Dimensions (Inches [mm])

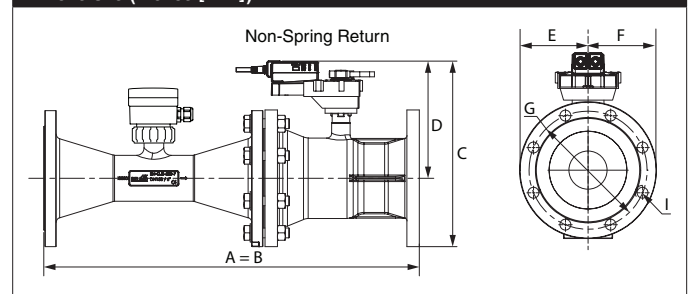

| A | B | C | D | E | F | G | I |
|--------------|---|-------------|-------------|------------|---|------------|------------|
| 22.85" [581] | | 11.9" [302] | 8.17" [208] | 4.5" [114] | | 7.5" [191] | 0.75" [19] |

Date created, 10/06/2017 - Subject to change. © Belimo Aircontrols (USA), Inc.

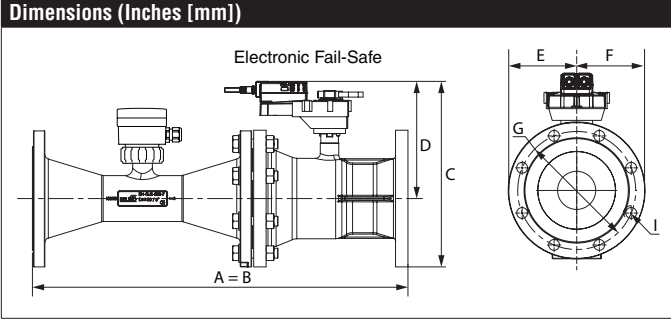

| A | B | C | D | E | F |
|--------------|---|--------------|---------------|------------|---|
| 22.85" [581] | | 12.67" [322] | 8.89" [225.8] | 4.5" [114] | |

GRX24-PI

Modulating, Non-Spring Return, 24 V, Multi-Function Technology®



| Technical Data | |
|-----------------------------------|--|
| Power Supply | 24 VAC ± 20%, 50/60 Hz, 24 VDC ± 10% |
| Power Consumption Running | 9.5 W |
| Transformer Sizing | 13 VA (class 2 power source) |
| Electrical Connection | 3ft [1m], 18 GA plenum cable with 1/2" conduit connector |
| Overload Protection | electronic throughout 0° to 90° rotation |
| Operating Range Y | 2 to 10 VDC (default) VDC variable |
| Input Impedance | 100 kΩ (0.1 mA), 500 Ω |
| Feedback Output U | 2 to 10 VDC (default) VDC variable |
| Angle of Rotation | 90° |
| Torque | 360 in-lbs [40 Nm] minimum |
| Direction of Rotation (Motor) | reversible with pc tool |
| Direction of Rotation (Fail-Safe) | reversible with switch |
| Position Indication | integrated into handle |
| Manual Override | external push button |
| Running Time (Motor) | 90 sec |
| Ambient Humidity | 5 to 95% RH non condensing (EN 60730-1) |
| Ambient Temperature Range | -22°F to 122°F [-30°C to 50°C] |
| Storage Temperature Range | -40°F to 176°F [-40°C to 80°C] |
| Housing | NEMA 2, IP54, UL Enclosure Type 2 |
| Housing Material | UL94-5VA |
| Agency Listings† | cULus acc. to UL60730-1A/-2-14, CAN/CSA E60730-1:02, CE acc. to 2004/108/EC and 2006/95/EC |
| Noise Level (Motor) | <45 dB (A) |
| Servicing | maintenance free |
| Quality Standard | ISO 9001 |
| Weight | 4.85 lb [2.2 kg] |





In cases where the valve body is electrically isolated from the water pipe, an earth ground should be installed in order for the sensor to work properly. Earth ground can be connected directly on the sensor body. A connection point is provided on the flange of the sensor body.

†Rated Impulse Voltage 800V, Type of action 1.AA, Control Pollution Degree 3

Date created, 10/06/2017 - Subject to change. © Belimo Aircontrols (USA), Inc.

Wiring Diagrams

INSTALLATION NOTES

-  Provide overload protection and disconnect as required.
-  Actuators may be connected in parallel. Power consumption and input impedance must be observed.
-  Actuators may also be powered by 24 VDC.
-  Actuators with plenum cable do not have numbers; use color codes instead.
-  Meets cULus requirements without the need of an electrical ground connection.

WARNING! LIVE ELECTRICAL COMPONENTS!
 During installation, testing, servicing and troubleshooting of this product, it may be necessary to work with live electrical components. Have a qualified licensed electrician or other individual who has been properly trained in handling live electrical components perform these tasks. Failure to follow all electrical safety precautions when exposed to live electrical components could result in death or serious injury.

