



5-year warranty



Technical data

Electrical data	Nominal voltage	AC/DC 24 V
	Nominal voltage frequency	50/60 Hz
	Power consumption in operation	5.5 W
	Power consumption in rest position	3 W
	Transformer sizing	8.5 VA (class 2 power source)
	Auxiliary switch	2 x SPDT, 3 A resistive (0.5 A inductive) @ AC 250 V, one set at 10°, one adjustable 10...90°
	Switching capacity auxiliary switch	3 A resistive (0.5 A inductive) @ AC 250 V
	Electrical Connection	(2) 18 GA appliance cables, 3 ft [1 m], 10 ft [3 m] or 16ft [5 m], with 1/2" conduit connectors
	Overload Protection	electronic throughout 0...95° rotation
	Electrical Protection	actuators are double insulated
Functional data	Torque motor	180 in-lb [20 Nm]
	Operating range Y	2...10 V
	Operating range Y note	4...20 mA w/ ZG-R01 (500 Ω, 1/4 W resistor)
	Input Impedance	100 kΩ for 2...10 V (0.1 mA), 500 Ω for 4...20 mA
	Position feedback U	2...10 V
	Position feedback U note	Max. 0.5 mA
	Direction of motion motor	selectable with switch 0/1
	Direction of motion fail-safe	reversible with cw/ccw mounting
	Manual override	5 mm hex crank (3/16" Allen), supplied
	Angle of rotation	95°
	Angle of rotation note	adjustable with mechanical end stop, 35...95°
	Running Time (Motor)	95 s / 90°
	Running time fail-safe	<20 s @ -4...122°F [-20...50°C], <60 s @ -22°F [-30°C]
	Noise level, motor	40 dB(A)
	Noise level, fail-safe	62 dB(A)
Shaft Diameter	1/2...1.05" round, centers on 3/4" with insert, 1.05" without insert	
Position indication	Mechanically, 5...20 mm stroke	
Safety data	Degree of protection IEC/EN	IP66
	Degree of protection NEMA/UL	NEMA 4X
	Enclosure	UL Enclosure Type 4X
	Agency Listing	cULus acc. to UL60730-1A/-2-14, CAN/CSA E60730-1:02, CE acc. to 2014/30/EU and 2014/35/EU
	Quality Standard	ISO 9001
	Ambient temperature	-22...122°F [-30...50°C]
	Ambient temperature note	-40...50°C for actuator with integrated heating

Safety data	Storage temperature	-40...176°F [-40...80°C]
	Ambient humidity	Max. 100% RH
	Servicing	maintenance-free
Weight	Weight	6.4 lb [2.9 kg]
Materials	Housing material	Polycarbonate

Footnotes †Rated Impulse Voltage 800V, Type of action 1.AA.B, Control Pollution Degree 4.

Product features

Application For modulation of dampers in HVAC systems. Actuator sizing should be done in accordance with the damper manufacturer's specifications. The actuator is mounted directly to a damper shaft up to 1.05" in diameter by means of its universal clamp. The actuator operates in response to a 2 to 10 VDC, with the addition of a 500Ω resistor, a 4 to 20 mA control input from an electronic controller or positioner. A 2 to 10 VDC feedback signal is provided for position indication. Not to be used for a master-slave application.

Operation The AF..24-SR-S N4 series actuators provide true spring return operation for reliable fail-safe application and positive close off on air tight dampers. The spring return system provides constant torque to the damper with, and without, power applied to the actuator. The AF..24-SR-S N4 series provides 95° of rotation and is provided with a graduated position indicator showing 0° to 95°. The AF..24-SR-S N4 uses a brushless DC motor which is controlled by an Application Specific Integrated Circuit (ASIC) and a microprocessor. The microprocessor provides the intelligence to the ASIC to provide a constant rotation rate and to know the actuator's exact fail-safe position. The ASIC monitors and controls the brushless DC motor's rotation and provides a digital rotation sensing function to prevent damage to the actuator in a stall condition. The actuator may be stalled anywhere in its normal rotation without the need of mechanical end switches. The AF..24-SR-S N4 versions are provided with two built-in auxiliary switches. These SPDT switches provide safety interfacing or signaling, for example, for fan start-up. The switching function at the fail-safe position is fixed at 10°, the other switch function is adjustable between 10° to 90°. The AF..24-SR-S N4 actuator is shipped at 5° (5° from full fail-safe) to provide automatic compression against damper gaskets for tight shut-off.

ATTENTION: AF..24-SR-S N4 cannot be tandem mounted on the same damper or valve shaft. Only On/Off and MFT AF.. models can be used for tandem mount applications.

Installation Note: Use suitable flexible metallic conduit or its equivalent with the conduit fitting. Not suitable for plenum applications.











For low ambient temperatures, the optional supplemental (-Y) Heater add-on is available.

Typical specification Spring return control damper actuators shall be direct coupled type which require no crank arm and linkage and be capable of direct mounting to a jackshaft up to a 1.05" diameter. The actuator must provide modulating damper control in response to a 2 to 10 VDC or, with the addition of a 500Ω resistor, a 4 to 20 mA control input from an electronic controller or positioner. The actuators must be designed so that they may be used for either clockwise or counter clockwise fail-safe operation. Actuators shall use a brushless DC motor controlled by a microprocessor and be protected from overload at all angles of rotation. Run time shall be constant, and independent of torque. A 2 to 10 VDC feedback signal shall be provided for position feedback. Actuators with auxiliary switches must be constructed to meet the requirements for Double Insulation so an electrical ground is not required to meet agency listings. Actuators shall be cULus listed and have a 5 year warranty, and be manufactured under ISO 9001 International Quality Control Standards. Actuators shall be as manufactured by Belimo.

Accessories

	Description	Type
Electrical accessories	Gasket for cable gland (NEMA 4 models)	11097-00001
	Cable Gland (NEMA 4 models)	43442-00001
	<p>DC Voltage Input Rescaling Module</p>	IRM-100
	Auxiliary switch, mercury-free	P475
	Auxiliary switch, mercury-free	P475-1
	<p>Convert Pulse Width Modulated Signal to a 2...10 V Signal for Belimo Proportional Actuators</p>	PTA-250
	Positioner for wall mounting	SGA24
	Positioner for front-panel mounting	SGF24
	Resistor, 500 Ω, 1/4" wire resistor with 6" pigtail wires	ZG-R01
	Resistor kit, 50% voltage divider	ZG-R02
	Transformer, AC 120 V to AC 24 V, 40 VA	ZG-X40
Mechanical accessories	Description	Type
	Anti-rotation bracket, for AF / NF	AF-P
	Ball joint suitable for damper crank arm KH8 / KH10, Multipack 10 pcs.	KG10A
	Damper crank arm Slot width 8.2 mm, clamping range Ø14...25 mm	KH10
	Push rod for KG10A ball joint 36" L, 3/8" diameter	SH10
	Wrench 0.32 in and 0.39 in [8 mm and 10 mm]	TOOL-06
	Wrench 0.512 in. [13 mm]	TOOL-07
	Damper clip for damper blade, 3.5" width.	ZG-DC1
	Damper clip for damper blade, 6" width.	ZG-DC2
	1" diameter jackshaft adaptor (11" L).	ZG-JSA-1
1-5/16" diameter jackshaft adaptor (12" L).	ZG-JSA-2	
1.05" diameter jackshaft adaptor (12" L).	ZG-JSA-3	
Service tools	Description	Type
Signal simulator, Power supply AC 120 V	PS-100	
Factory add-on option only	Description	Type
Heater, with adjustable thermostat	N4 Heater Add-on 24V (-H)	

Electrical installation

-  **Warning! Live electrical components!**
During installation, testing, servicing and troubleshooting of this product, it may be necessary to work with live electrical components. Have a qualified licensed electrician or other individual who has been properly trained in handling live electrical components perform these tasks. Failure to follow all electrical safety precautions when exposed to live electrical components could result in death or serious injury.
-  Meets cULus requirements without the need of an electrical ground connection.
-  Apply only AC line voltage or only UL-Class 2 voltage to the terminals of auxiliary switches. Mixed or combined operation of line voltage/safety extra low voltage is not allowed.
-  Actuators with appliance cables are numbered.
-  Provide overload protection and disconnect as required.
-  Actuators may also be powered by DC 24 V.
-  Two built-in auxiliary switches (2x SPDT), for end position indication, interlock control, fan startup, etc.
-  Only connect common to negative (-) leg of control circuits.
-  A 500 Ω resistor (ZG-R01) converts the 4...20 mA control signal to 2...10 V.
-  Actuators may be connected in parallel if not mechanically linked. Power consumption and input impedance must be observed.

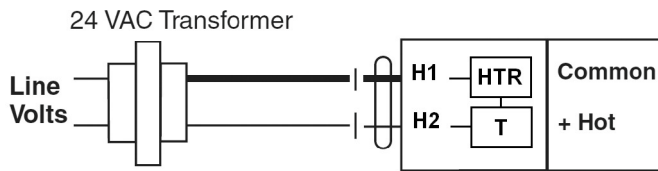

NEMA 4 Heater Option

Wiring diagrams

2...10 V / 4...20 mA Control

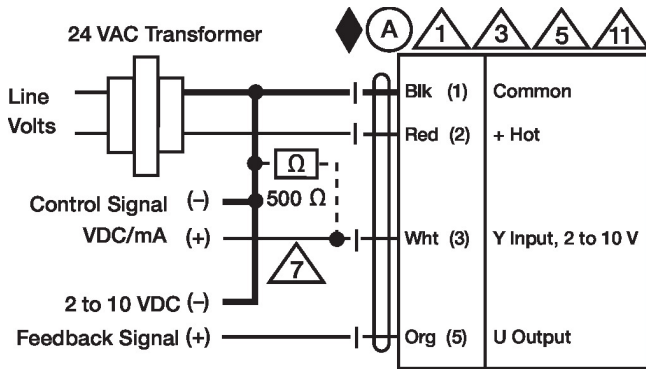

Auxiliary Switches

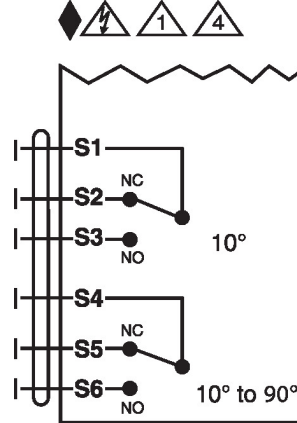

NEMA 4 Heater Option

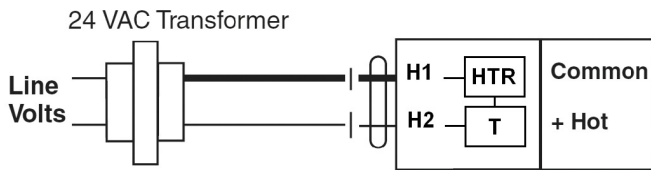

Dimensions

