



2-year warranty

Type overview

Type	DN
B2050VS-04	15

Technical data

Functional data	Valve size [mm]	0.5" [15]
	Fluid	chilled or hot water, up to 60% glycol, steam
	Fluid Temp Range (water)	-22...280°F [-30...138°C]
	Body Pressure Rating	600 psig WOG
	Close-off pressure Δps	600 psi
	Flow characteristic	modified equal percentage
	Max Differential Pressure (Steam)	35 psi
	Flow Pattern	2-way
	Leakage rate	ANSI Class VI
	Controllable flow range	90° rotation
	Cv	4
	Maximum Inlet Pressure (Steam)	35 psi [241 kPa]
	Maximum Velocity	15 FPS
Materials	Valve body	Bronze B584-C84400
	Housing seal	PTFE
	Spindle	316 stainless steel
	Spindle seal	RPTFE
	Seat	RPTFE
	Lock nut	stainless steel
	Pipe connection	NPT female ends
	Retainer	B16 Brass
Ball	316 stainless steel	
Suitable actuators	Non-Spring	LMB(X) GRCB(X) GRB(X)
	Spring	LF

Safety notes



- WARNING: This product can expose you to lead which is known to the State of California to cause cancer and reproductive harm. For more information go to www.p65warnings.ca.gov

Product features

Application This valve is typically used in air handling units on heating or cooling coils, and fan coil unit heating or cooling coils. Some other common applications include Unit Ventilators, VAV Box re-heat coils and bypass loops. This valve is suitable for use in a hydronic system with variable flow. This valve is designed with MFT functionally which facilitates the use of various control input.

Up to 35 psi steam
 1/2" - 2" 600 PSIG WOG, Cold Non-Shock
 Federal Specification: WW-V-35C, Type II
 Composition: BZ
 Style: 3

Flow/Mounting details



Dimensions

Type	DN
B2050VS-04	15

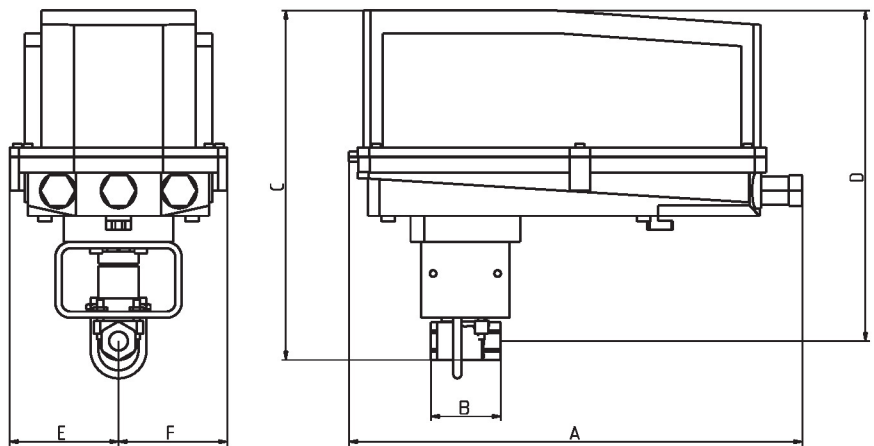

B2050VS..+GRC..N4

A	B	C	D	E	F
14.1" [358]	2.2" [56]	10.9" [277]	10.3" [262]	3.4" [86]	3.4" [86]



5-year warranty



Technical data

Electrical data	Nominal voltage	AC/DC 24 V
	Nominal voltage frequency	50/60 Hz
	Power consumption in operation	2.5 W
	Power consumption in rest position	1.2 W
	Transformer sizing	5 VA (class 2 power source)
	Electrical Connection	18 GA plenum cable, 3 ft [1 m], with 1/2" conduit connector (10 ft [3 m] and 15 ft [5 m] available)
	Overload Protection	electronic throughout 0...95° rotation
Functional data	Operating range Y	2...10 V
	Operating range Y note	4...20 mA w/ ZG-R01 (500 Ω, 1/4 W resistor)
	Operating range Y variable	Start point 0.5...30 V End point 2.5...32 V
	Options positioning signal	variable (VDC, on/off, floating point)
	Position feedback U	2...10 V
	Position feedback U note	Max. 0.5 mA
	Position feedback U variable	VDC variable
	Direction of motion motor	selectable with switch 0/1
	Manual override	external push button
	Angle of rotation	Max. 95°
	Angle of rotation note	adjustable with mechanical stop
	Running Time (Motor)	150 s / 90°
	Running time motor variable	30...150 s
	Noise level, motor	35 dB(A)
Position indication	Mechanically, 30...65 mm stroke	
Safety data	Degree of protection IEC/EN	IP54
	Degree of protection NEMA/UL	NEMA 2
	Enclosure	UL Enclosure Type 2
	Agency Listing	cULus acc. to UL60730-1A/-2-14, CAN/CSA E60730-1:02, CE acc. to 2014/30/EU and 2014/35/EU; Listed to UL 2043 - suitable for use in air plenums per Section 300.22(c) of the NEC and Section 602.2 of the IMC
	Quality Standard	ISO 9001
	Ambient temperature	-22...122°F [-30...50°C]
	Storage temperature	-40...176°F [-40...80°C]
	Ambient humidity	Max. 95% RH, non-condensing
	Servicing	maintenance-free
	Materials	Housing material

Footnotes †Rated Impulse Voltage 800V, Type action 1, Control Pollution Degree 3.

Accessories

Electrical accessories	Description	Type
	Battery backup system, for non-spring return models	NSV24 US
	Battery, 12 V, 1.2 Ah (two required)	NSV-BAT
	Feedback potentiometer 140 Ω add-on, grey	P140A GR
	Feedback potentiometer 500 Ω add-on, grey	P500A GR
	Feedback potentiometer 1 kΩ add-on, grey	P1000A GR
	Feedback potentiometer 2.8 kΩ add-on, grey	P2800A GR
	Feedback potentiometer 5 kΩ add-on, grey	P5000A GR
	Feedback potentiometer 10 kΩ add-on, grey	P10000A GR
	Auxiliary switch 1 x SPDT add-on	S1A
	Auxiliary switch 2 x SPDT add-on	S2A

Electrical installation

✂ INSTALLATION NOTES

- Ⓐ Actuators with appliance cables are numbered.
- ⚠ Provide overload protection and disconnect as required.
- ⚠ Actuators may also be powered by DC 24 V.
- ⚠ Only connect common to negative (-) leg of control circuits.
- ⚠ A 500 Ω resistor (ZG-R01) converts the 4...20 mA control signal to 2...10 V.
- ⚠ Control signal may be pulsed from either the Hot (Source) or Common (Sink) 24 V line.
- ⚠ For triac sink the Common connection from the actuator must be connected to the Hot connection of the controller. Position feedback cannot be used with a triac sink controller; the actuator internal common reference is not compatible.
- ⚠ Actuators may be connected in parallel if not mechanically linked. Power consumption and input impedance must be observed.
- ◆ Meets cULus requirements without the need of an electrical ground connection.
- ⚠ **Warning! Live electrical components!**
During installation, testing, servicing and troubleshooting of this product, it may be necessary to work with live electrical components. Have a qualified licensed electrician or other individual who has been properly trained in handling live electrical components perform these tasks. Failure to follow all electrical safety precautions when exposed to live electrical components could result in death or serious injury.

Wiring diagrams

On/Off

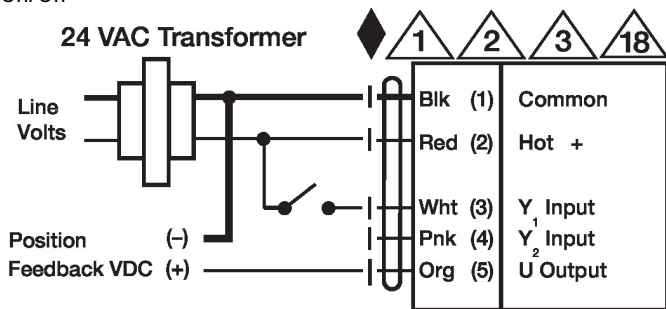

Floating Point

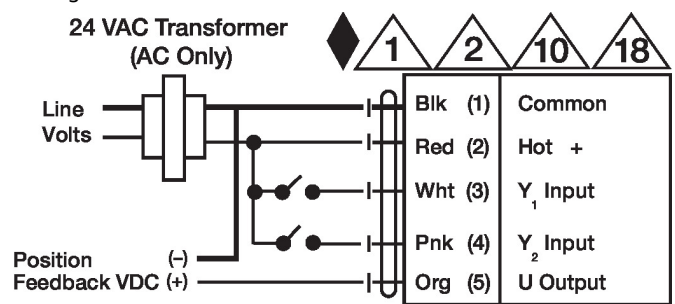

VDC/mA Control

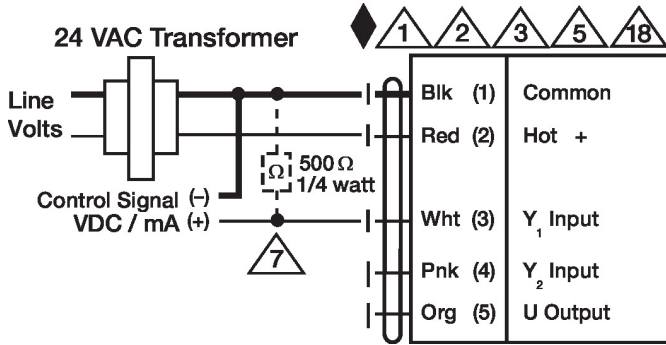

PWM Control

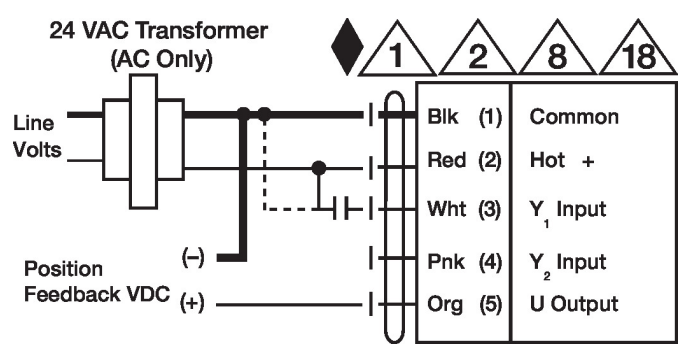

Override Control

