



5-year warranty



Technical data

Functional data	Valve Size	0.5" [15]
	Fluid	chilled or hot water, up to 60% glycol
	Fluid Temp Range (water)	0...250°F [-18...120°C]
	Body Pressure Rating	600 psi
	Body pressure rating note	600 psi
	Close-off pressure Δps	200 psi
	Flow characteristic	equal percentage
	Servicing	maintenance-free
	Flow Pattern	2-way
	Leakage rate	0% for A – AB
	Controllable flow range	75°
	Cv	0.46
	Cv Flow Rating	A-port: as stated in chart B-port: 70% of A – AB Cv
	Materials	Valve body
Stem		nickel-plated brass
Stem seal		EPDM (lubricated)
Seat		PTFE
Characterizing disk		TEFZEL®
Pipe connection		NPT female ends
O-ring		EPDM (lubricated)
Ball		chrome plated brass
Suitable actuators	Non-Spring	TR LRB(X)
	Spring	TFRB(X) LF

Safety notes



- WARNING: This product can expose you to lead which is known to the State of California to cause cancer and reproductive harm. For more information go to www.p65warnings.ca.gov

Product features

Application This valve is typically used in air handling units on heating or cooling coils, and fan coil unit heating or cooling coils. Some other common applications include Unit Ventilators, VAV box re-heat coils and bypass loops. This valve is suitable for use in a hydronic system with variable flow.

Flow/Mounting details

Two-way valves should be installed with the disc upstream.



Dimensions

Dimensional drawings

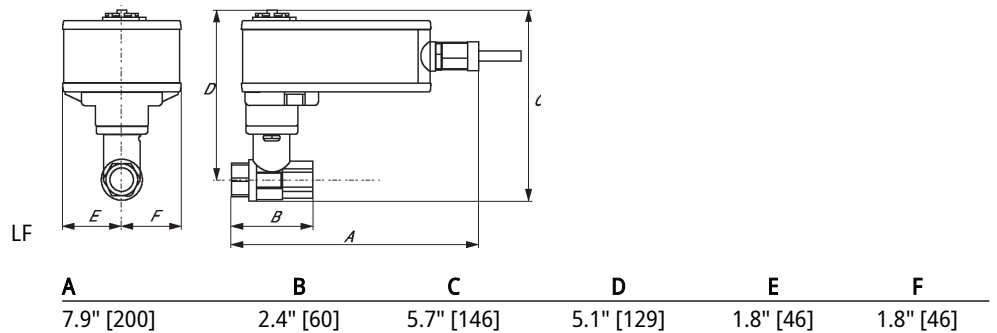
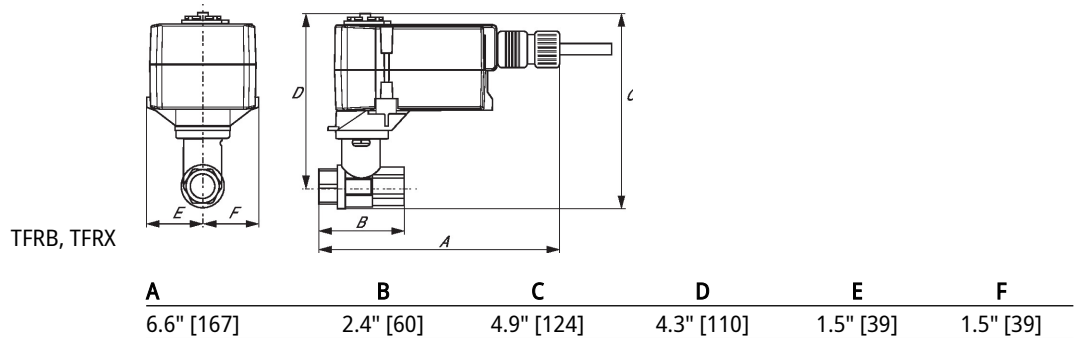
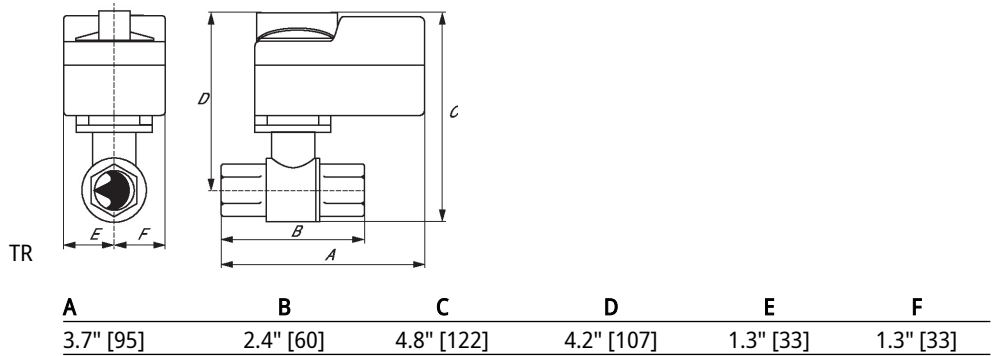
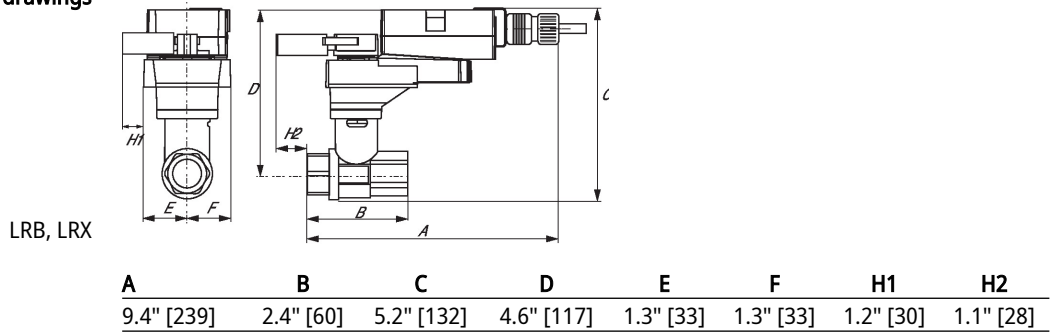

On/Off, Spring Return Fail-Safe, AC 120 V

On/Off, Spring Return, 120/230 VAC, Torque min. 35 in-lb, for control of air dampers



5-year warranty

Technical data

Electrical data	Nominal voltage	AC 120 V
	Nominal voltage frequency	50/60 Hz
	Power consumption in operation	5.5 W
	Power consumption in rest position	3.5 W
	Transformer sizing	7.5 VA
	Electrical Connection	18 GA appliance cable, 3 ft [1 m], with 1/2" conduit connector
	Overload Protection	electronic throughout 0...95° rotation
	Electrical Protection	actuators are double insulated
Functional data	Torque motor	35 in-lb [4 Nm]
	Direction of motion motor	selectable with switch 0/1
	Direction of motion fail-safe	reversible with cw/ccw mounting
	Angle of rotation	Max. 95°
	Running Time (Motor)	75 s
	Running time fail-safe	<25 s @ -4...122°F [-20...50°C], <60 s @ -22°F [-30°C]
	Noise level, motor	50 dB(A)
	Noise level, fail-safe	62 dB(A)
	Shaft Diameter	3/8...1/2" round, centers on 1/2"
	Position indication	Mechanical
Safety data	Degree of protection IEC/EN	IP54
	Degree of protection NEMA/UL	NEMA 2
	Enclosure	UL Enclosure Type 2
	Agency Listing	cULus acc. To UL 873 and CAN/CSA C22.2 No. 24-93; Listed to UL 2043 - suitable for use in air plenums per Section 300.22(c) of the NEC and Section 602.2 of the IMC
	Quality Standard	ISO 9001
	Ambient temperature	-22...122°F [-30...50°C]
	Storage temperature	-40...176°F [-40...80°C]
	Ambient humidity	Max. 95% RH, non-condensing
	Servicing	maintenance-free
	Weight	Weight
Materials	Housing material	galvanized steel

Product features

Application For On/Off, fail-safe control of dampers in HVAC systems. Actuator sizing should be done in accordance with the damper manufacturer’s specifications. Control is On/Off from an auxiliary contact or a manual switch. The actuator is mounted directly to a damper shaft from 3/8” up to 1/2” in diameter by means of its universal clamp, 1/2” shaft centered at delivery. For shafts up to 3/4” use K6-1 accessory. A crank arm and several mounting brackets are available for applications where the actuator cannot be direct coupled to the damper shaft.

Operation The LF series actuators provide true spring return operation for reliable fail-safe application and positive close off on air tight dampers. The spring return system provides consistent torque to the damper with, and without, power applied to the actuator. The LF series provides 95° of rotation and is provided with a graduated position indicator showing 0...95°. The actuator may be stalled anywhere in its normal rotation without the need of mechanical end switches. Power consumption is reduced in holding mode. The actuator is double insulated so an electrical ground connection is not necessary.

Typical specification On/Off spring return damper actuators shall be direct coupled type which require no crank arm and linkage and be capable of direct mounting to a shaft up to a 3/4" diameter and center on a 1/2" shaft (default). Actuator shall deliver a minimum output torque of 35 in-lbs. The actuator must be designed so that they may be used for either clockwise or counter clockwise failsafe operation. Actuators shall be protected from overload at all angles of rotation. If required, one SPDT auxiliary switch shall be provided with one switch having the capability of being adjustable. Actuators with auxiliary switch must be constructed to meet the requirement for Double Insulation so an electrical ground connection is not required to meet agency listings. Actuators shall be cULus listed, have a 5 year warranty, and be manufactured under ISO 9001 International Quality Control Standards. Actuators shall be as manufactured by Belimo.

Accessories

Electrical accessories	Description	Type
	Auxiliary switch, mercury-free	P475
	Auxiliary switch, mercury-free	P475-1
	Signal simulator, Power supply AC 120 V	PS-100

Mechanical accessories	Description	Type
	Shaft extension 170 mm Ø10 mm for damper shaft Ø 6...16 mm	AV6-20
	End stop indicator	IND-LF
	Shaft clamp for LF..	K6 US
	Shaft clamp reversible, clamping range Ø16...20 mm	K6-1
	Ball joint suitable for damper crank arm KH8 / KH10	KG10A
	Ball joint suitable for damper crank arm KH8	KG6
	Ball joint suitable for damper crank arm KH8	KG8
	Actuator arm, clamping range Ø8...16 mm, Slot width 8.2 mm	KH-LF
	V-bolt Kit for KH-LF.	KH-LFV
	Damper crank arm Slot width 8.2 mm, for Ø1.05"	KH12
	Damper crank arm Slot width 6.2 mm, clamping range Ø10...18 mm	KH6
	Damper crank arm Slot width 8.2 mm, clamping range Ø10...18 mm	KH8
	Anti-rotation bracket LF.	LF-P
	Push rod for KG10A ball joint 36" L, 3/8" diameter	SH10
	Push rod for KG6 & KG8 ball joints (36" L, 5/16" diameter).	SH8
	Wrench 0.32 in and 0.39 in [8 mm and 10 mm]	TOOL-06
	Angle of rotation limiter, with end stop	ZDB-LF
	Form fit adapter 8x8 mm	ZF8-LF
	Mounting Bracket: ZS-260 Right Angle	ZG-109
	Linkage kit	ZG-110
	Mounting bracket for LF..	ZG-112
	Damper clip for damper blade, 3.5" width.	ZG-DC1
	Damper clip for damper blade, 6" width.	ZG-DC2
	LF crankarm adaptor kit (includes ZG-112).	ZG-LF112
	LF crankarm adaptor kit (T bracket included).	ZG-LF2
	Shaft extension for 3/8" diameter shafts (4" L).	ZG-LMSA-1
	Shaft extension for 1/2" diameter shafts (5" L).	ZG-LMSA-1/2-5
	Weather shield 330x203x152 mm [13x8x6"] (LxBxH)	ZS-100
	Base plate, for ZS-100	ZS-101
	Weather shield 406x213x102 mm [16x8-3/8x4"] (LxWxH)	ZS-150
	Explosion proof housing 406x254x164 mm [16x10x6.435"] (LxBxH), UL and CSA, Class I, Zone 1&2, Groups B, C, D, (NEMA 7), Class III, Hazardous (classified) Locations	ZS-260
	Weather shield 438x222x140 mm [17-1/4x8-3/4x5-1/2"] (LxBxH), NEMA 4X, with mounting brackets	ZS-300
	Weather shield 438x222x140 mm [17-1/4x8-3/4x5-1/2"] (LxBxH), NEMA 4X, with mounting brackets	ZS-300-5
	Shaft extension 1/2"	ZS-300-C1
	Shaft extension 3/4"	ZS-300-C2
	Shaft extension 1"	ZS-300-C3

Electrical installation



Warning! Live electrical components!

During installation, testing, servicing and troubleshooting of this product, it may be necessary to work with live electrical components. Have a qualified licensed electrician or other individual who has been properly trained in handling live electrical components perform these tasks. Failure to follow all electrical safety precautions when exposed to live electrical components could result in death or serious injury.



Meets cULus requirements without the need of an electrical ground connection.



Actuators with appliance cables are numbered.



Provide overload protection and disconnect as required.



Actuators may be connected in parallel if not mechanically linked. Power consumption and input impedance must be observed.

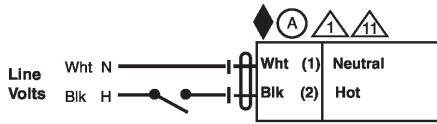

On/Off

Dimensions

Dimensional drawings

