



5-year warranty

Type overview

Type	DN
B220HT464	20

Technical data

<b>Functional data</b>	Valve size [mm]	0.75" [20]
	Fluid	high temperature hot water/low pressure steam, up to 60% glycol
	Fluid Temp Range (water)	60...266°F [16...130°C]
	Fluid Temp Range (steam)	250°F [120°C]
	Body Pressure Rating	600 psi
	Close-off pressure Δps	200 psi
	Flow characteristic	A-port equal percentage
	Servicing	maintenance-free
	Max Differential Pressure (Steam)	15 psi
	Flow Pattern	2-way
	Leakage rate	0%
	Controllable flow range	75°
	Cv	4.64
Maximum Inlet Pressure (Steam)	15 psi	
<b>Materials</b>	Valve body	Nickel-plated brass (DZR) P-CuZn35Pb2
	Spindle	stainless steel
	Spindle seal	Viton O-ring
	Seat	ETFE
	Characterized disc	ETFE
	Pipe connection	NPT female ends
	O-ring	EPDM (lubricated)
Ball	stainless steel	
<b>Suitable actuators</b>	Non-Spring	LRB(X)
	Spring	LF

Safety notes



- WARNING: This product can expose you to lead which is known to the State of California to cause cancer and reproductive harm. For more information go to [www.p65warnings.ca.gov](http://www.p65warnings.ca.gov)

Product features

**Application** This valve is typically used in air handling units on heating or cooling coils, and fan coil unit heating or cooling coils. Some other common applications include unit ventilators, VAV box re-heat coils and bypass loops. This valve is suitable for use in a hydronic system with variable flow. This valve is designed to fit in compact areas where on/off, floating point and modulating control is required using 24 VAC.

Flow/Mounting details



Dimensions

Type	DN
B220HT464	20

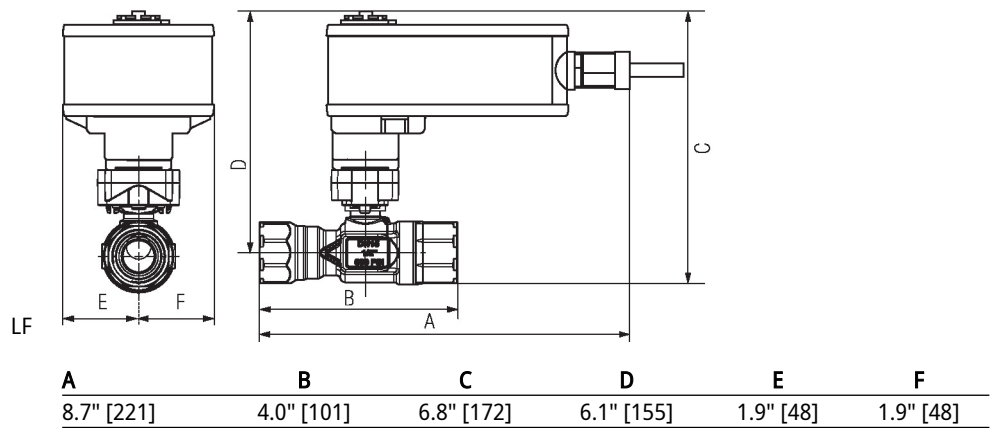
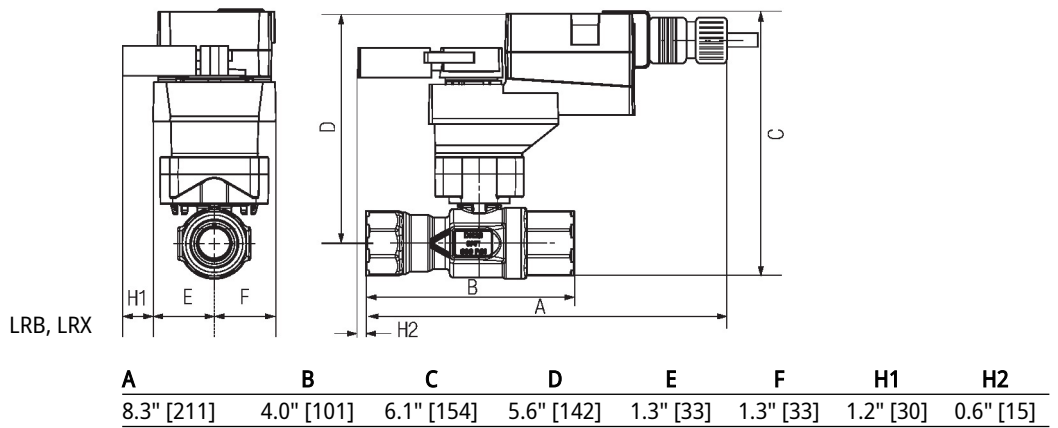



5-year warranty



Technical data

<b>Electrical data</b>	Nominal voltage	AC/DC 24 V
	Nominal voltage frequency	50/60 Hz
	Power consumption in operation	2.5 W
	Power consumption in rest position	1 W
	Transformer sizing	5 VA (class 2 power source)
	Electrical Connection	18 GA plenum cable, 3 ft [1 m], with 1/2" conduit connector
	Overload Protection	electronic throughout 0...95° rotation
	Electrical Protection	actuators are double insulated
<b>Functional data</b>	Torque motor	35 in-lb [4 Nm]
	Direction of motion motor	selectable with switch 0/1
	Direction of motion fail-safe	reversible with cw/ccw mounting
	Angle of rotation	Max. 95°
	Running Time (Motor)	150 s / 90°
	Running time motor note	constant, independent of load
	Running time fail-safe	<25 s @ -4...122°F [-20...50°C], <60 s @ -22°F [-30°C]
	Noise level, motor	30 dB(A)
	Noise level, fail-safe	62 dB(A)
	Shaft Diameter	3/8...1/2" round, centers on 1/2"
Position indication	Mechanical	
<b>Safety data</b>	Degree of protection IEC/EN	IP54
	Degree of protection NEMA/UL	NEMA 2
	Enclosure	UL Enclosure Type 2
	Agency Listing	cULus acc. To UL 873 and CAN/CSA C22.2 No. 24-93; Listed to UL 2043 - suitable for use in air plenums per Section 300.22(c) of the NEC and Section 602.2 of the IMC
	Quality Standard	ISO 9001
	Ambient temperature	-22...122°F [-30...50°C]
	Storage temperature	-40...176°F [-40...80°C]
	Ambient humidity	Max. 95% RH, non-condensing
	Servicing	maintenance-free
	<b>Materials</b>	Housing material

**Footnotes** †Rated Impulse Voltage 800V, Type of action 1.AA, Control Pollution Degree 3

Product features

**Application** For modulation or On/Off, fail-safe control of dampers in HVAC systems. Actuator sizing should be done in accordance with the damper manufacturer’s specifications. The actuator is mounted directly to a damper shaft from 3/8” up to 1/2” in diameter by means of its universal clamp, 1/2” shaft centered at delivery. For shafts up to 3/4” use K6-1 accessory. A crank arm and several mounting brackets are available for applications where the actuator cannot be direct coupled to the damper shaft. Control is floating point from a triac or relay, or On/Off from an auxiliary contact from a fan motor contactor, controller or manual switch.

**Operation** The LF series actuators provide true spring return operation for reliable fail-safe application and positive close-off on air tight dampers. The spring return system provides consistent torque to the damper with, and without, power applied to the actuator. The LF series provides 95° of rotation and is provided with a graduated position indicator showing 0 to 95°. The LF uses a brushless DC motor which is controlled by an Application Specific Integrated Circuit (ASIC) and a microprocessor. The microprocessor provides the intelligence to the ASIC to provide a constant rotation rate and to know the actuator’s exact fail-safe position. The ASIC monitors and controls the brushless DC motor’s rotation and provides a digital rotation sensing function to prevent damage to the actuator in a stall condition. The actuator may be stalled anywhere in its normal rotation without the need of mechanical end switches. Power consumption is reduced in holding mode.

**Typical specification** Floating point, On/Off spring return damper actuators shall be direct coupled type which require no crank arm and linkage and be capable of direct mounting to a shaft up to a 3/4” diameter and centers on a 1/2” shaft (default). The actuators must be designed so that they may be used for either clockwise or counter clockwise fail-safe operation. Actuators shall have an external direction of rotation switch to reverse control logic. Actuators shall use a brushless DC motor and be protected from overload at all angles of rotation. If required, one SPDT auxiliary switch shall be provided having the capability of being adjustable. Actuators with auxiliary switch must be constructed to meet the requirements for Double Insulation so an electrical ground is not required to meet agency listings. Run time shall be constant and independent of torque. Actuators shall be cULus listed, have a 5 year warranty, and be manufactured under ISO 9001 International Quality Control Standards. Actuators shall be as manufactured by Belimo.

Accessories

Electrical accessories	Description	Type
	Auxiliary switch, mercury-free	P475
	Auxiliary switch, mercury-free	P475-1
	Signal simulator, Power supply AC 120 V	PS-100
	Transformer, AC 120 V to AC 24 V, 40 VA	ZG-X40

Mechanical accessories	Description	Type
	Shaft extension 170 mm Ø10 mm for damper shaft Ø 6...16 mm	AV6-20
	End stop indicator	IND-LF
	Shaft clamp for LF..	K6 US
	Shaft clamp reversible, clamping range Ø16...20 mm	K6-1
	Ball joint suitable for damper crank arm KH8 / KH10, Multipack 10 pcs.	KG10A
	Ball joint suitable for damper crank arm KH8, Multipack 10 pcs.	KG6
	Ball joint suitable for damper crank arm KH8, Multipack 10 pcs.	KG8
	Damper crank arm Slot width 8.2 mm, for Ø1.05"	KH12
	Damper crank arm Slot width 6.2 mm, clamping range Ø10...18 mm	KH6
	Damper crank arm Slot width 8.2 mm, clamping range Ø10...18 mm	KH8
	Actuator arm, clamping range Ø8...16 mm, Slot width 8.2 mm	KH-LF
	V-bolt Kit for KH-LF.	KH-LFV
	Anti-rotation bracket LF.	LF-P
	Push rod for KG10A ball joint 36" L, 3/8" diameter	SH10
	Push rod for KG6 & KG8 ball joints (36" L, 5/16" diameter).	SH8
	Wrench 0.32 in and 0.39 in [8 mm and 10 mm]	TOOL-06
	Angle of rotation limiter, with end stop	ZDB-LF
	Form fit adapter 8x8 mm	ZF8-LF
	<p>Mounting Bracket: ZS-260 Right Angle</p>	ZG-109
	<p>Linkage kit</p>	ZG-110
	Mounting bracket for LF..	ZG-112
	Damper clip for damper blade, 3.5" width.	ZG-DC1
	Damper clip for damper blade, 6" width.	ZG-DC2
	LF crankarm adaptor kit (includes ZG-112).	ZG-LF112
	LF crankarm adaptor kit (T bracket included).	ZG-LF2
	Shaft extension for 3/8" diameter shafts (4" L).	ZG-LMSA-1
	Shaft extension for 1/2" diameter shafts (5" L).	ZG-LMSA-1/2-5
	Weather shield 330x203x152 mm [13x8x6"] (LxBxH)	ZS-100
	Base plate, for ZS-100	ZS-101
	Weather shield 406x213x102 mm [16x8-3/8x4"] (LxWxH)	ZS-150
	Explosion proof housing 406x254x164 mm [16x10x6.435"] (LxBxH), UL and CSA, Class I, Zone 1&2, Groups B, C, D, (NEMA 7), Class III, Hazardous (classified) Locations	ZS-260
	Weather shield 438x222x140 mm [17-1/4x8-3/4x5-1/2"] (LxBxH), NEMA 4X, with mounting brackets	ZS-300
	Weather shield 438x222x140 mm [17-1/4x8-3/4x5-1/2"] (LxBxH), NEMA 4X, with mounting brackets	ZS-300-5
	Shaft extension 1/2"	ZS-300-C1
	Shaft extension 3/4"	ZS-300-C2
	Shaft extension 1"	ZS-300-C3

## Electrical installation



### Warning! Live electrical components!

During installation, testing, servicing and troubleshooting of this product, it may be necessary to work with live electrical components. Have a qualified licensed electrician or other individual who has been properly trained in handling live electrical components perform these tasks. Failure to follow all electrical safety precautions when exposed to live electrical components could result in death or serious injury.



Meets cULus requirements without the need of an electrical ground connection.



Actuators with appliance cables are numbered.



Provide overload protection and disconnect as required.



Actuators may also be powered by DC 24 V.



Actuators Hot wire must be connected to the control board common. Only connect common to neg. (-) leg of control circuits. Terminal models (-T) have no-feedback.



Actuators may be connected in parallel if not mechanically linked. Power consumption and input impedance must be observed.

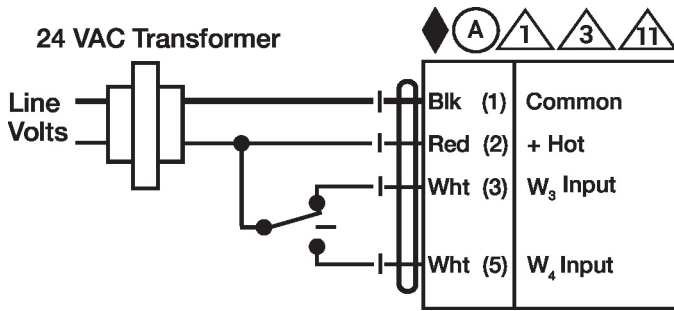

Floating Point

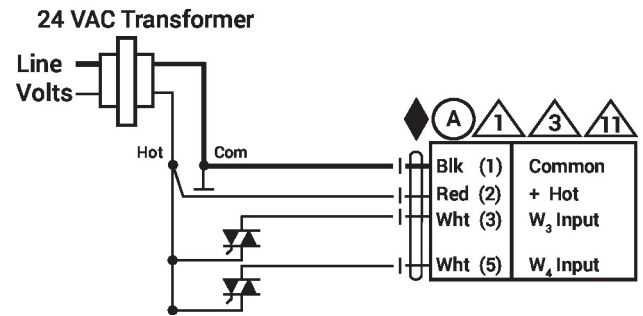

Floating Point - Triac Source

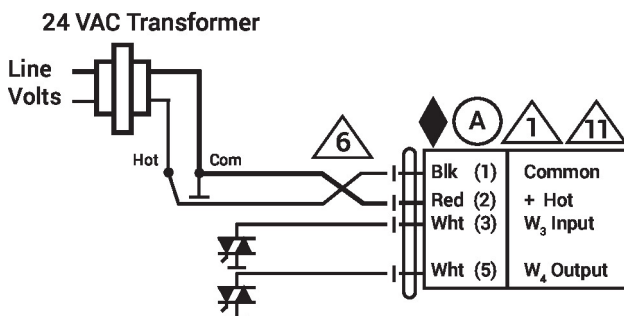

Floating Point - Triac Sink

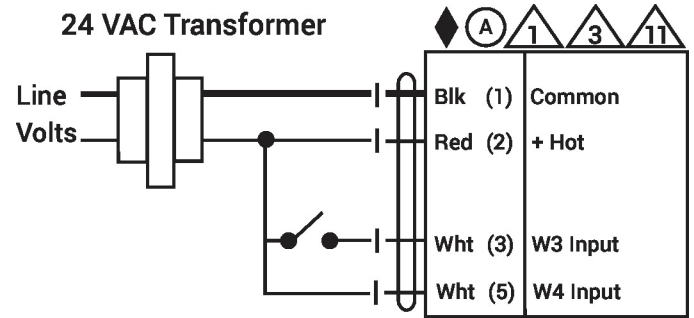

On/Off

**Dimensions**

