



2-year warranty

Type overview

Type	DN
B224VSS	25

Technical data

<b>Functional data</b>	Valve size [mm]	1" [25]
	Fluid	chilled or hot water, up to 60% glycol, steam
	Fluid Temp Range (water)	-22...298°F [-30...148°C]
	Body Pressure Rating	1500 psig WOG
	Close-off pressure Δps	1000 psi
	Flow characteristic	modified equal percentage
	Max Differential Pressure (Steam)	50 psi
	Flow Pattern	2-way
	Leakage rate	ANSI Class VI
	Controllable flow range	90° rotation
	Cv	43
	Maximum Inlet Pressure (Steam)	50 psi
	Maximum Velocity	15 FPS
<b>Materials</b>	Valve body	Stainless steel A351-CF8M 316
	Housing seal	PTFE
	Spindle	316 stainless steel
	Spindle seal	RPTFE
	Seat	RPTFE
	Lock nut	stainless steel
	Pipe connection	SAE NPT (female connections)
	Ball	316 stainless steel
<b>Suitable actuators</b>	Non-Spring	AMB(X) GRCB(X) GRB(X)
	Spring	AF

Safety notes



- WARNING: This product can expose you to lead which is known to the State of California to cause cancer and reproductive harm. For more information go to [www.p65warnings.ca.gov](http://www.p65warnings.ca.gov)

Product features

**Application** These threaded valves are designed to provide modulating or two position control of hot or chilled water and saturated steam systems under 50 psi.  
 Typical applications include reheat coils, VAV terminal control, unit ventilators, and air handlers, especially in areas which have minimum profile requirements.  
 Up to 50 psi steam  
 1/2" - 2000 PSIG WOG, Cold Non-Shock  
 Federal Specification: WW-V-35C, Type II  
 Composition: SS  
 Style: 3

Flow/Mounting details



Dimensions

Type  
 B224VSS

DN  
 25

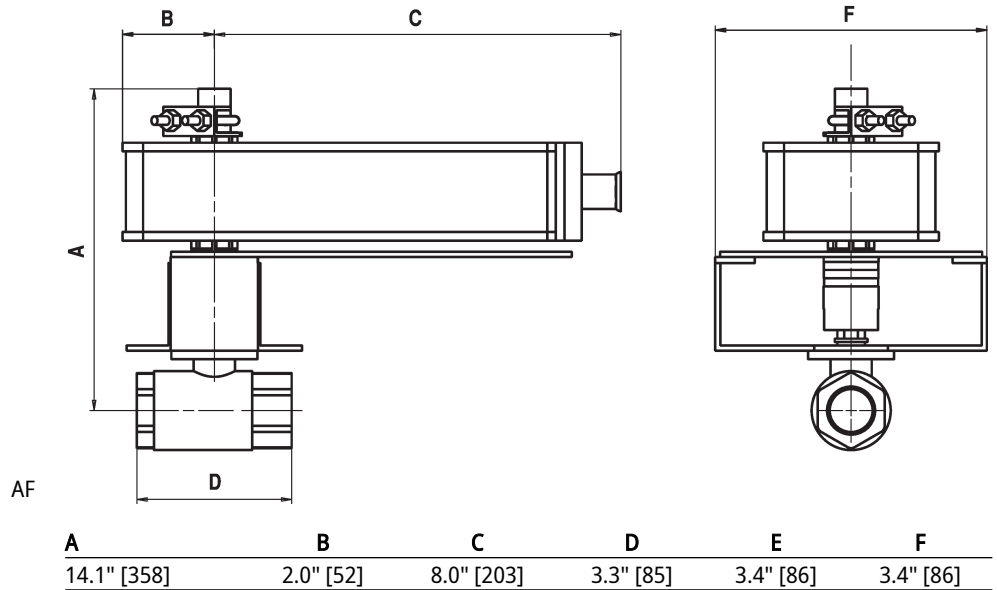

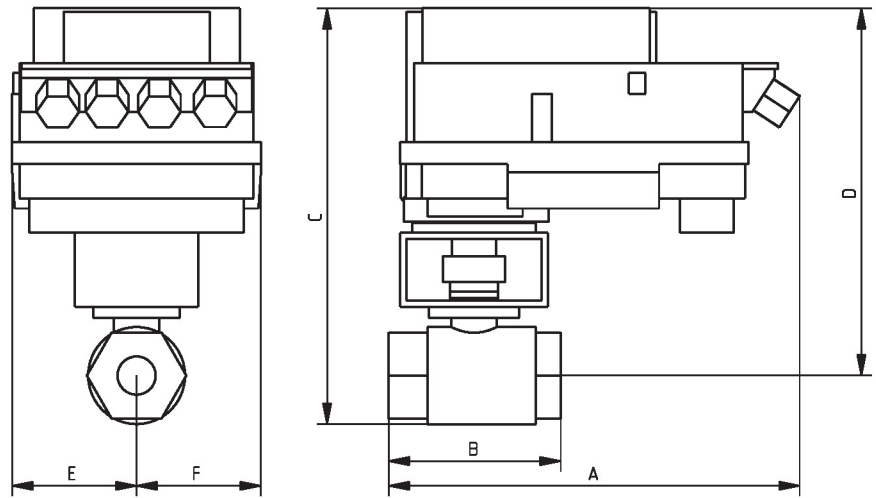

B249VSS+PKR..

A	B	C	D	E	F
14.1" [358]	3.4" [86]	12.1" [307]	11.1" [283]	3.4" [86]	3.4" [86]



5-year warranty













Technical data

<b>Electrical data</b>	Nominal voltage	AC 24...240 V / DC 24...125 V
	Nominal voltage frequency	50/60 Hz
	Power consumption in operation	7 W
	Power consumption in rest position	3.5 W
	Power consumption for wire sizing	18 VA
	Transformer sizing	7 VA @ AC 24 V (class 2 power source), 8.5 VA @ AC 120 V, 18 VA @ AC 240 V
	Auxiliary switch	2 x SPDT, 3 A resistive (0.5 A inductive) @ AC 250 V, one set at 10°, one adjustable 10...90°
	Switching capacity auxiliary switch	3 A resistive (0.5 A inductive) @ AC 250 V
	Electrical Connection	(2) 18 GA appliance cables with 1/2" conduit connectors, 3 ft [1 m],
	Overload Protection	electronic throughout 0...95° rotation
<b>Functional data</b>	Position feedback U note	No Feedback
	Direction of motion motor	selectable by ccw/cw mounting
	Direction of motion fail-safe	reversible with cw/ccw mounting
	Manual override	5 mm hex crank (3/16" Allen), supplied
	Angle of rotation	95°
	Running Time (Motor)	75 s / 90°
	Running time fail-safe	<20 s
	Noise level, motor	50 dB(A)
	Noise level, fail-safe	62 dB(A)
Position indication	Mechanical	
<b>Safety data</b>	Degree of protection IEC/EN	IP54
	Degree of protection NEMA/UL	NEMA 2
	Enclosure	UL Enclosure Type 2
	Agency Listing	cULus acc. to UL60730-1A/-2-14, CAN/CSA E60730-1:02, CE acc. to 2014/30/EU and 2014/35/EU; Listed to UL 2043 - suitable for use in air plenums per Section 300.22(c) of the NEC and Section 602.2 of the IMC
	Quality Standard	ISO 9001
	Ambient temperature	-22...122°F [-30...50°C]
	Storage temperature	-40...176°F [-40...80°C]
	Ambient humidity	Max. 95% RH, non-condensing
	Servicing	maintenance-free
	<b>Materials</b>	Housing material

**Footnotes** †Rated Impulse Voltage 4kV, Type of Action 1.AA.B, Control Pollution Degree 3.

Electrical installation

-  **Warning! Live electrical components!**  
During installation, testing, servicing and troubleshooting of this product, it may be necessary to work with live electrical components. Have a qualified licensed electrician or other individual who has been properly trained in handling live electrical components perform these tasks. Failure to follow all electrical safety precautions when exposed to live electrical components could result in death or serious injury.
-  Meets cULus requirements without the need of an electrical ground connection.
-  Actuators with appliance cables are numbered.
-  Universal Power Supply (UP) models can be supplied with 24 VAC up to 240 VAC, or 24 VDC up to 125 VDC.
-  Apply only AC line voltage or only UL-Class 2 voltage to the terminals of auxiliary switches. Mixed or combined operation of line voltage/safety extra low voltage is not allowed.
-  Provide overload protection and disconnect as required.
-  Actuators may also be powered by DC 24 V.
-  Two built-in auxiliary switches (2x SPDT), for end position indication, interlock control, fan startup, etc.
-  Actuators may be powered in parallel. Power consumption must be observed.
-  Parallel wiring required for piggy-back applications.

**Wiring diagrams**

On/Off

