



5-year warranty

Type overview

Type	DN
B225HT731	25

Technical data

Functional data	Valve size [mm]	1" [25]
	Fluid	high temperature hot water/low pressure steam, up to 60% glycol
	Fluid Temp Range (water)	60...266°F [16...130°C]
	Fluid Temp Range (steam)	250°F [120°C]
	Body Pressure Rating	600 psi
	Close-off pressure Δps	200 psi
	Flow characteristic	A-port equal percentage
	Servicing	maintenance-free
	Max Differential Pressure (Steam)	15 psi
	Flow Pattern	2-way
	Leakage rate	0%
	Controllable flow range	75°
	Cv	7.31
	Maximum Inlet Pressure (Steam)	15 psi
Materials	Valve body	Nickel-plated brass (DZR) P-CuZn35Pb2
	Spindle	stainless steel
	Spindle seal	Viton O-ring
	Seat	ETFE
	Characterized disc	ETFE
	Pipe connection	NPT female ends
	O-ring	EPDM (lubricated)
Suitable actuators	Ball	stainless steel
	Non-Spring	LRB(X)
	Spring	LF

Safety notes



- WARNING: This product can expose you to lead which is known to the State of California to cause cancer and reproductive harm. For more information go to www.p65warnings.ca.gov

Product features

Application This valve is typically used in air handling units on heating or cooling coils, and fan coil unit heating or cooling coils. Some other common applications include unit ventilators, VAV box re-heat coils and bypass loops. This valve is suitable for use in a hydronic system with variable flow. This valve is designed to fit in compact areas where on/off, floating point and modulating control is required using 24 VAC.

Flow/Mounting details



Dimensions

Type	DN
B225HT731	25

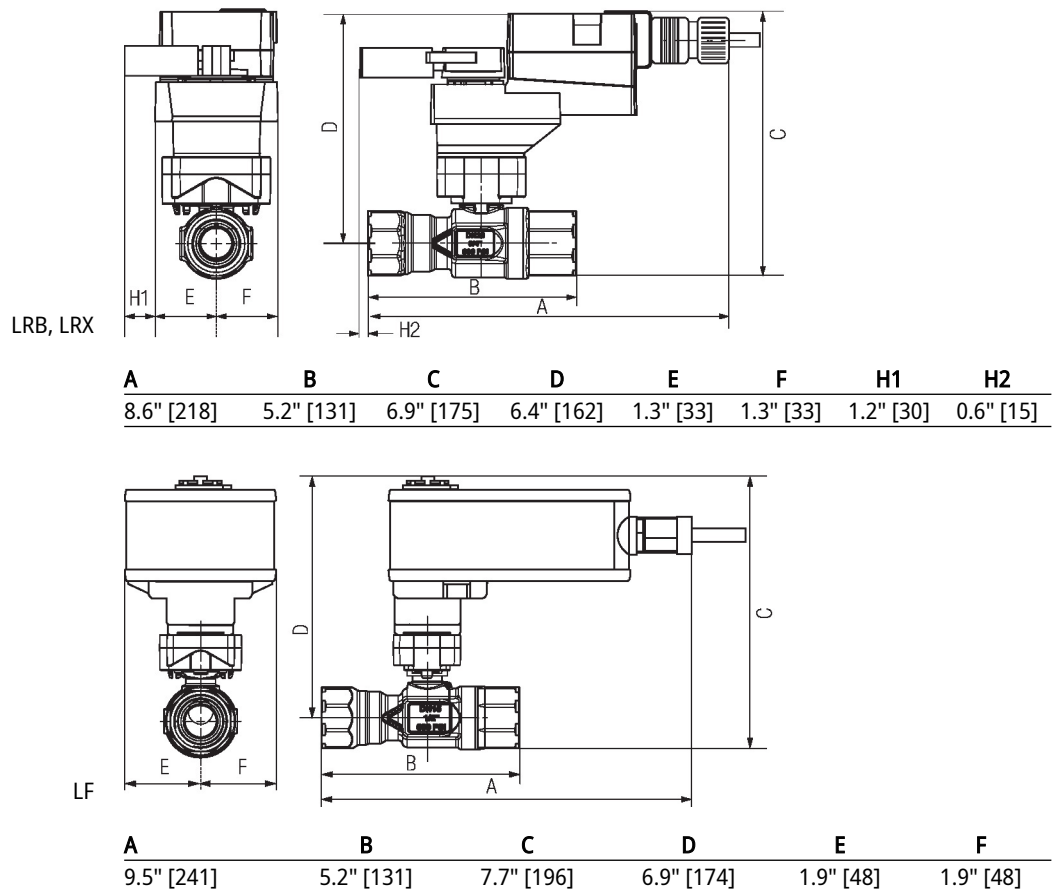



5-year warranty



Technical data

Electrical data	Nominal voltage	AC/DC 24 V
	Nominal voltage frequency	50/60 Hz
	Power consumption in operation	1.5 W
	Power consumption in rest position	0.4 W
	Power consumption for wire sizing	3 VA
	Transformer sizing	3 VA (class 2 power source)
	Electrical Connection	18 GA plenum cable, 3 ft [1 m], with 1/2" conduit connector
	Overload Protection	electronic throughout 0...90° rotation
Functional data	Operating range Y	2...10 V
	Operating range Y note	4...20 mA w/ ZG-R01 (500 Ω, 1/4 W resistor)
	Input Impedance	100 kΩ for 2...10 V (0.1 mA), 500 Ω for 4...20 mA
	Position feedback U	2...10 V
	Position feedback U note	Max. 1 mA
	Direction of motion motor	selectable with switch 0/1
	Manual override	external push button
	Angle of rotation	90°
	Angle of rotation note	adjustable with mechanical stop
	Running Time (Motor)	90 s / 90°
	Noise level, motor	35 dB(A)
	Position indication	Mechanically, pluggable
Safety data	Degree of protection IEC/EN	IP54
	Degree of protection NEMA/UL	NEMA 2
	Enclosure	UL Enclosure Type 2
	Agency Listing	cULus acc. to UL60730-1A/-2-14, CAN/CSA E60730-1:02, CE acc. to 2014/30/EU Listed to UL 2043 - suitable for use in air plenums per Section 300.22(C) of the NEC and Section 602 of the IMC
	Quality Standard	ISO 9001
	Ambient temperature	-22...122°F [-30...50°C]
	Storage temperature	-40...176°F [-40...80°C]
	Ambient humidity	Max. 95% RH, non-condensing
	Servicing	maintenance-free
	Materials	Housing material

Footnotes †Rated Impulse Voltage 800V, Type action 1.B, Control Pollution Degree 3.

Accessories

Electrical accessories	Description	Type
	Battery backup system, for non-spring return models	NSV24 US
	Battery, 12 V, 1.2 Ah (two required)	NSV-BAT
	Auxiliary switch 1 x SPDT add-on	S1A
	Auxiliary switch 2 x SPDT add-on	S2A
	Feedback potentiometer 140 Ω add-on, grey	P140A GR
	Feedback potentiometer 1 k Ω add-on, grey	P1000A GR
	Feedback potentiometer 10 k Ω add-on, grey	P10000A GR
	Feedback potentiometer 2.8 k Ω add-on, grey	P2800A GR
	Feedback potentiometer 500 Ω add-on, grey	P500A GR
	Feedback potentiometer 5 k Ω add-on, grey	P5000A GR

Electrical installation

INSTALLATION NOTES

- 1 Provide overload protection and disconnect as required.
- 2 Actuators may be connected in parallel. Power consumption and input impedance must be observed.
- 3 Actuators may also be powered by DC 24 V.
- 5 Only connect common to negative (-) leg of control circuits.
- 7 A 500 Ω resistor (ZG-R01) converts the 4...20 mA control signal to 2...10 V.
- 18 Actuators with plenum cable do not have numbers; use color codes instead.
- Meets cULus requirements without the need of an electrical ground connection.
- Warning! Live electrical components!**
During installation, testing, servicing and troubleshooting of this product, it may be necessary to work with live electrical components. Have a qualified licensed electrician or other individual who has been properly trained in handling live electrical components perform these tasks. Failure to follow all electrical safety precautions when exposed to live electrical components could result in death or serious injury.

Wiring diagrams

2...10 V / 4...20 mA Control

