



2-year warranty

Type overview

Type	DN
B232VS	32

Technical data

Functional data	Valve size [mm]	1.25" [32]
	Fluid	chilled or hot water, up to 60% glycol, steam
	Fluid Temp Range (water)	-22...280°F [-30...138°C]
	Body Pressure Rating	600 psig WOG psi
	Close-off pressure Δps	600 psi
	Flow characteristic	modified equal percentage
	Max Differential Pressure (Steam)	35 psi
	Flow Pattern	2-way
	Leakage rate	ANSI Class VI
	Controllable flow range	90° rotation
	Cv	48
	Maximum Inlet Pressure (Steam)	35 psi [241 kPa]
	Maximum Velocity	15 FPS
Materials	Valve body	Bronze B584-C84400
	Housing seal	PTFE
	Spindle	316 stainless steel
	Spindle seal	RPTFE
	Seat	RPTFE
	Lock nut	stainless steel
	Pipe connection	NPT female ends
	Retainer	B584-C84400 bronze
Ball	316 stainless steel	
Suitable actuators	Non-Spring	AMB(X) GRCB(X) GRB(X)
	Spring	AF

Safety notes



- WARNING: This product can expose you to lead which is known to the State of California to cause cancer and reproductive harm. For more information go to www.p65warnings.ca.gov

Product features

Application This valve is typically used in air handling units on heating or cooling coils, and fan coil unit heating or cooling coils. Some other common applications include Unit Ventilators, VAV Box re-heat coils and bypass loops. This valve is suitable for use in a hydronic system with variable flow. This valve is designed with MFT functionally which facilitates the use of various control input.

Up to 35 psi steam
 1/2" - 2" 600 PSIG WOG, Cold Non-Shock
 Federal Specification: WW-V-35C, Type II
 Composition: BZ
 Style: 3

Flow/Mounting details

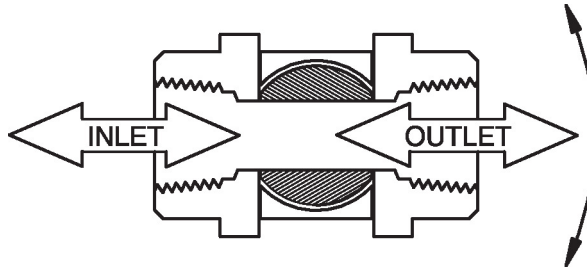

Dimensions

Type	DN
B232VS	32

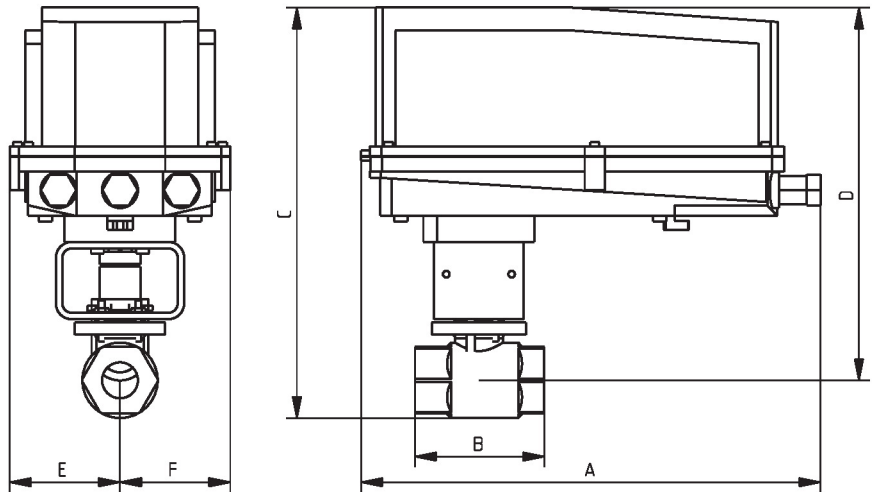

B232VS+GRC..N4

A	B	C	D	E	F
14.1" [358]	4.0" [101]	12.6" [320]	11.4" [290]	3.4" [86]	3.4" [86]



5-year warranty













Technical data

Electrical data	Nominal voltage	AC 24...240 V / DC 24...125 V
	Nominal voltage frequency	50/60 Hz
	Power consumption in operation	7 W
	Power consumption in rest position	3.5 W
	Power consumption for wire sizing	18 VA
	Transformer sizing	7 VA @ AC 24 V (class 2 power source), 8.5 VA @ AC 120 V, 18 VA @ AC 240 V
	Auxiliary switch	2 x SPDT, 3 A resistive (0.5 A inductive) @ AC 250 V, one set at 10°, one adjustable 10...90°
	Switching capacity auxiliary switch	3 A resistive (0.5 A inductive) @ AC 250 V
	Electrical Connection	(2) 18 GA appliance cables with 1/2" conduit connectors, 3 ft [1 m],
	Overload Protection	electronic throughout 0...95° rotation
Functional data	Position feedback U note	No Feedback
	Direction of motion motor	selectable by ccw/cw mounting
	Direction of motion fail-safe	reversible with cw/ccw mounting
	Manual override	5 mm hex crank (3/16" Allen), supplied
	Angle of rotation	95°
	Running Time (Motor)	75 s / 90°
	Running time fail-safe	<20 s
	Noise level, motor	50 dB(A)
	Noise level, fail-safe	62 dB(A)
Position indication	Mechanical	
Safety data	Degree of protection IEC/EN	IP54
	Degree of protection NEMA/UL	NEMA 2
	Enclosure	UL Enclosure Type 2
	Agency Listing	cULus acc. to UL60730-1A/-2-14, CAN/CSA E60730-1:02, CE acc. to 2014/30/EU and 2014/35/EU; Listed to UL 2043 - suitable for use in air plenums per Section 300.22(c) of the NEC and Section 602.2 of the IMC
	Quality Standard	ISO 9001
	Ambient temperature	-22...122°F [-30...50°C]
	Storage temperature	-40...176°F [-40...80°C]
	Ambient humidity	Max. 95% RH, non-condensing
	Servicing	maintenance-free
	Materials	Housing material

Footnotes †Rated Impulse Voltage 4kV, Type of Action 1.AA.B, Control Pollution Degree 3.

Electrical installation

-  **Warning! Live electrical components!**
During installation, testing, servicing and troubleshooting of this product, it may be necessary to work with live electrical components. Have a qualified licensed electrician or other individual who has been properly trained in handling live electrical components perform these tasks. Failure to follow all electrical safety precautions when exposed to live electrical components could result in death or serious injury.
-  Meets cULus requirements without the need of an electrical ground connection.
-  Actuators with appliance cables are numbered.
-  Universal Power Supply (UP) models can be supplied with 24 VAC up to 240 VAC, or 24 VDC up to 125 VDC.
-  Apply only AC line voltage or only UL-Class 2 voltage to the terminals of auxiliary switches. Mixed or combined operation of line voltage/safety extra low voltage is not allowed.
-  Provide overload protection and disconnect as required.
-  Actuators may also be powered by DC 24 V.
-  Two built-in auxiliary switches (2x SPDT), for end position indication, interlock control, fan startup, etc.
-  Actuators may be powered in parallel. Power consumption must be observed.
-  Parallel wiring required for piggy-back applications.

Wiring diagrams
On/Off

