



2-year warranty

Type overview

Type	DN
B239VS	40

Technical data

Functional data	Valve size [mm]	1.5" [40]
	Fluid	chilled or hot water, up to 60% glycol, steam
	Fluid Temp Range (water)	-22...280°F [-30...138°C]
	Body Pressure Rating	600 psig WOG psi
	Close-off pressure Δ ps	600 psi
	Flow characteristic	modified equal percentage
	Max Differential Pressure (Steam)	35 psi
	Flow Pattern	2-way
	Leakage rate	ANSI Class VI
	Controllable flow range	90° rotation
	Cv	84
	Maximum Inlet Pressure (Steam)	35 psi [241 kPa]
	Maximum Velocity	15 FPS
Materials	Valve body	Bronze B584-C84400
	Housing seal	PTFE
	Spindle	316 stainless steel
	Spindle seal	RPTFE
	Seat	RPTFE
	Lock nut	stainless steel
	Pipe connection	NPT female ends
	Retainer	B584-C84400 bronze
Ball	316 stainless steel	
Suitable actuators	Non-Spring	GMB(X)
		PRB(X)
		GRCB(X)
GRB(X)		
Spring	AF	
Electrical fail-safe	PKRB(X)	

Safety notes



- **WARNING:** This product can expose you to lead which is known to the State of California to cause cancer and reproductive harm. For more information go to www.p65warnings.ca.gov

Product features

Application This valve is typically used in air handling units on heating or cooling coils, and fan coil unit heating or cooling coils. Some other common applications include Unit Ventilators, VAV Box re-heat coils and bypass loops. This valve is suitable for use in a hydronic system with variable flow. This valve is designed with MFT functionally which facilitates the use of various control input.

Up to 35 psi steam
 1/2" - 2" 600 PSIG WOG, Cold Non-Shock
 Federal Specification: WW-V-35C, Type II
 Composition: BZ
 Style: 3

Flow/Mounting details



Dimensions

Type	DN
B239VS	40

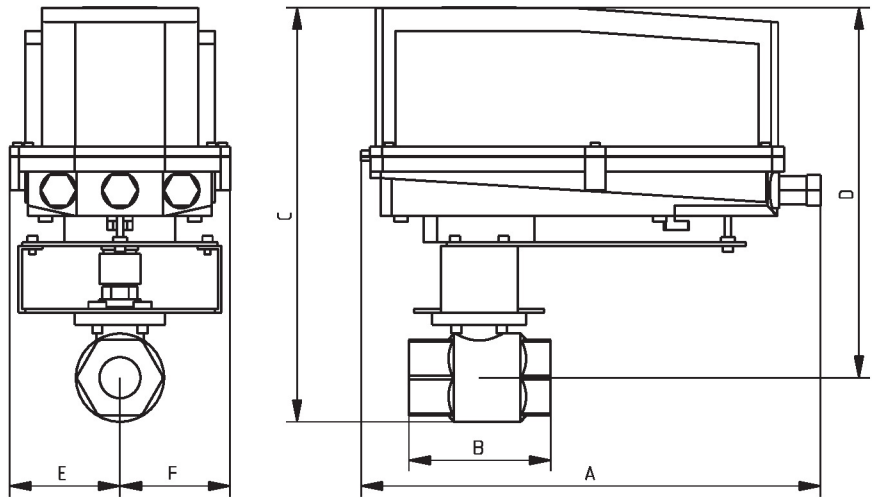

B239VS+GRC..N4

A	B	C	D	E	F
11.7" [297.5]	4.4" [112]	9.7" [247]	7.7" [196]	2.3" [58]	2.3" [58]



5-year warranty









Technical data

Electrical data	Nominal voltage	AC/DC 24 V
	Nominal voltage frequency	50/60 Hz
	Power consumption in operation	5 W
	Power consumption in rest position	2.5 W
	Transformer sizing	14 VA @ AC 24 V (class 2 power source), 17 VA @ AC 120 V, 36 VA @ AC 240 V
	Electrical Connection	18 GA appliance cable, 3 ft [1 m], with 1/2" conduit connector
	Overload Protection	electronic throughout 0...95° rotation
Functional data	Direction of motion motor	selectable by ccw/cw mounting
	Direction of motion fail-safe	reversible with cw/ccw mounting
	Manual override	5 mm hex crank (3/16" Allen), supplied
	Angle of rotation	95°
	Running Time (Motor)	75 s / 90°
	Running time fail-safe	<20 s
	Noise level, motor	50 dB(A)
	Noise level, fail-safe	62 dB(A)
Position indication	Mechanical	
Safety data	Degree of protection IEC/EN	IP54
	Degree of protection NEMA/UL	NEMA 2
	Enclosure	UL Enclosure Type 2
	Agency Listing	cULus acc. to UL60730-1A/-2-14, CAN/CSA E60730-1:02, CE acc. to 2014/30/EU Listed to UL 2043 - suitable for use in air plenums per Section 300.22(C) of the NEC and Section 602 of the IMC
	Quality Standard	ISO 9001
	Ambient temperature	-22...122°F [-30...50°C]
	Storage temperature	-40...176°F [-40...80°C]
	Ambient humidity	Max. 95% RH, non-condensing
Servicing	maintenance-free	
Materials	Housing material	Galvanized steel and plastic housing

Footnotes *Variable when configured with MFT options.

Electrical installation

-  Meets cULus requirements without the need of an electrical ground connection.
-  Actuators with appliance cables are numbered.
-  Provide overload protection and disconnect as required.

-  Actuators may also be powered by DC 24 V.
-  Actuators may be powered in parallel. Power consumption must be observed.
-  Parallel wiring required for piggy-back applications.

Wiring diagrams

On/Off

