



2-year warranty

Type overview

|        |    |
|--------|----|
| Type   | DN |
| B239VS | 40 |

Technical data

|                           |                                   |   |
|---------------------------|-----------------------------------|---|
| <b>Functional data</b>    | Valve size [mm]                   | 1.5" [40]                                     |
|                           | Fluid                             | chilled or hot water, up to 60% glycol, steam |
|                           | Fluid Temp Range (water)          | -22...280°F [-30...138°C]                     |
|                           | Body Pressure Rating              | 600 psig WOG psi                              |
|                           | Close-off pressure $\Delta$ ps    | 600 psi                                       |
|                           | Flow characteristic               | modified equal percentage                     |
|                           | Max Differential Pressure (Steam) | 35 psi  |
|                           | Flow Pattern                      | 2-way   |
|                           | Leakage rate                      | ANSI Class VI                                 |
|                           | Controllable flow range           | 90° rotation                                  |
|                           | Cv                                | 84  |
|                           | Maximum Inlet Pressure (Steam)    | 35 psi [241 kPa]                              |
|                           | Maximum Velocity                  | 15 FPS  |
| <b>Materials</b>          | Valve body                        | Bronze B584-C84400                            |
|                           | Housing seal                      | PTFE  |
|                           | Spindle                           | 316 stainless steel                           |
|                           | Spindle seal                      | RPTFE   |
|                           | Seat                              | RPTFE   |
|                           | Lock nut                          | stainless steel                               |
|                           | Pipe connection                   | NPT female ends                               |
|                           | Retainer                          | B584-C84400 bronze                            |
| Ball                      | 316 stainless steel               |   |
| <b>Suitable actuators</b> | Non-Spring                        | GMB(X)  |
|                           |                                   | PRB(X)  |
|                           |                                   | GRCB(X)                                       |
| GRB(X)                    |                                   |   |
| Spring                    | AF                                |   |
| Electrical fail-safe      | PKRB(X)                           |   |

Safety notes



- WARNING: This product can expose you to lead which is known to the State of California to cause cancer and reproductive harm. For more information go to [www.p65warnings.ca.gov](http://www.p65warnings.ca.gov)

Product features

**Application** This valve is typically used in air handling units on heating or cooling coils, and fan coil unit heating or cooling coils. Some other common applications include Unit Ventilators, VAV Box re-heat coils and bypass loops. This valve is suitable for use in a hydronic system with variable flow. This valve is designed with MFT functionally which facilitates the use of various control input.

Up to 35 psi steam  
 1/2" - 2" 600 PSIG WOG, Cold Non-Shock  
 Federal Specification: WW-V-35C, Type II  
 Composition: BZ  
 Style: 3

Flow/Mounting details



Dimensions

|        |    |
|--------|----|
| Type   | DN |
| B239VS | 40 |

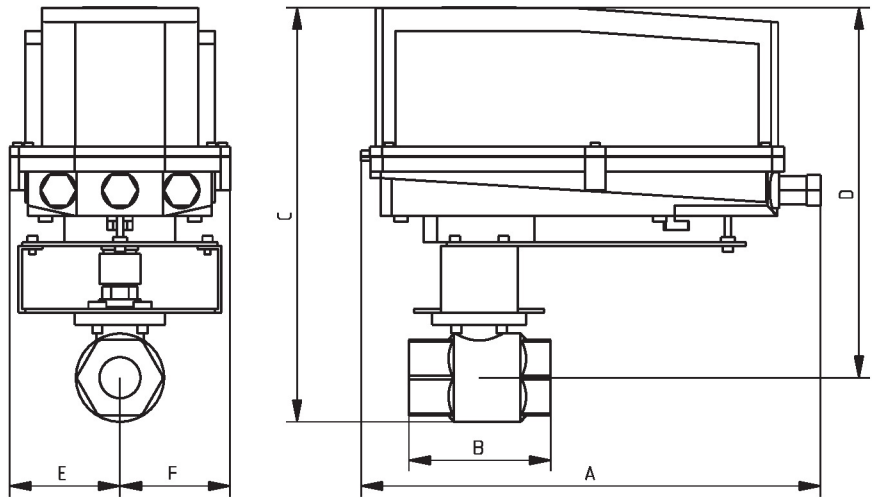

B239VS+GRC..N4

| A             | B          | C          | D          | E         | F         |
|---------------|------------|------------|------------|-----------|-----------|
| 11.7" [297.5] | 4.4" [112] | 9.7" [247] | 7.7" [196] | 2.3" [58] | 2.3" [58] |



5-year warranty













**Technical data**

|                               |                                     |  |
|-------------------------------|-------------------------------------|--|
| <b>Electrical data</b>        | Nominal voltage                     | AC 24...240 V / DC 24...125 V  |
|                               | Nominal voltage frequency           | 50/60 Hz   |
|                               | Power consumption in operation      | 7.5 W  |
|                               | Power consumption in rest position  | 3.5 W  |
|                               | Transformer sizing                  | 14 VA @ AC 24 V (class 2 power source), 17 VA @ AC 120 V, 36 VA @ AC 240 V   |
|                               | Auxiliary switch                    | 2 x SPDT, 3 A resistive (0.5 A inductive) @ AC 250 V, one set at 10°, one adjustable 10...90°  |
|                               | Switching capacity auxiliary switch | 3 A resistive (0.5 A inductive) @ AC 250 V   |
|                               | Electrical Connection               | (2) 18 GA appliance cables with 1/2" conduit connectors, 3 ft [1 m],   |
|                               | Overload Protection                 | electronic throughout 0...95° rotation   |
|                               | <b>Functional data</b>              | Position feedback U note   |
| Direction of motion motor     |                                     | selectable by ccw/cw mounting  |
| Direction of motion fail-safe |                                     | reversible with cw/ccw mounting  |
| Manual override               |                                     | 5 mm hex crank (3/16" Allen), supplied   |
| Angle of rotation             |                                     | 95°  |
| Running Time (Motor)          |                                     | 75 s / 90°   |
| Running time fail-safe        |                                     | <20 s  |
| Noise level, motor            |                                     | 50 dB(A)   |
| Noise level, fail-safe        |                                     | 62 dB(A)   |
| Position indication           | Mechanical                          |  |
| <b>Safety data</b>            | Degree of protection IEC/EN         | IP54   |
|                               | Degree of protection NEMA/UL        | NEMA 2   |
|                               | Enclosure                           | UL Enclosure Type 2  |
|                               | Agency Listing                      | cULus acc. to UL60730-1A/-2-14, CAN/CSA E60730-1:02, CE acc. to 2014/30/EU Listed to UL 2043 - suitable for use in air plenums per Section 300.22(C) of the NEC and Section 602 of the IMC |
|                               | Quality Standard                    | ISO 9001   |
|                               | Ambient temperature                 | -22...122°F [-30...50°C]   |
|                               | Storage temperature                 | -40...176°F [-40...80°C]   |
|                               | Ambient humidity                    | Max. 95% RH, non-condensing  |
|                               | Servicing                           | maintenance-free   |
|                               | <b>Materials</b>                    | Housing material   |

**Footnotes** †Rated Impulse Voltage 4kV, Type of Action 1.AA.B, Control Pollution Degree 3.

Electrical installation

-  **Warning! Live electrical components!**  
During installation, testing, servicing and troubleshooting of this product, it may be necessary to work with live electrical components. Have a qualified licensed electrician or other individual who has been properly trained in handling live electrical components perform these tasks. Failure to follow all electrical safety precautions when exposed to live electrical components could result in death or serious injury.
-  Actuators with appliance cables are numbered.
-  Meets cULus requirements without the need of an electrical ground connection.
-  Universal Power Supply (UP) models can be supplied with 24 VAC up to 240 VAC, or 24 VDC up to 125 VDC.
-  Apply only AC line voltage or only UL-Class 2 voltage to the terminals of auxiliary switches. Mixed or combined operation of line voltage/safety extra low voltage is not allowed.
-  Provide overload protection and disconnect as required.
-  Actuators may also be powered by DC 24 V.
-  Two built-in auxiliary switches (2x SPDT), for end position indication, interlock control, fan startup, etc.
-  Actuators may be powered in parallel. Power consumption must be observed.
-  Parallel wiring required for piggy-back applications.

**Wiring diagrams**

On/Off

