

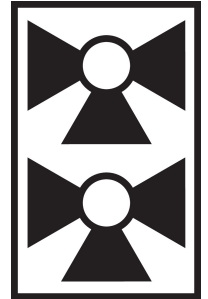

5-year warranty



Technical data

Functional data	Valve Size	0.75" [20]
	Fluid	chilled or hot water, up to 60% glycol
	Fluid Temp Range (water)	43...180°F [6...82°C]
	Body Pressure Rating	232 psi
	Close-off pressure Δps	50 psi
	Flow characteristic	linear
	Servicing	maintenance-free
	Flow Pattern	6-way
	Leakage rate	0%
	Controllable flow range	sequence 1 (angle 0...30°), dead zone (30...60°), sequence 2 (angle 60...90°)
	Seq 1 Cv	2.9
	Seq 2 Cv	1.16
	Materials	Valve body
Spindle		nickel-plated brass
Spindle seal		EPDM (lubricated)
Seat		PTFE
Characterized disc		chrome plated steel
Pipe connection		NPT female ends
O-ring		EPDM
Ball		chrome plated brass

Product features

- Application** The 6-way characterized control valve is ideal for chilled beams, radiant ceilings, and fan coil units offering reduced wiring by using a single actuator instead of two. It eliminates the need for a change-over valve and enables the use of a single coil for heating and cooling.
- Operation** A loop pressure relief is designed into port number two (2). This allows the increased pressure to dissipate to the supply loop on port number one (1). This is intended to release any pressure build up in the loop (coil) when the valve is in the closed position and is isolated from the system expansion vessel. The change in pressure occurs due to a change in the media temperature in the coil while isolated from the pressure vessel. The pressure relief does not affect the efficiency of the system because cross-flow cannot occur between the heating and cooling loops. The system loops (heating/cooling) should share a common expansion vessel to keep the system pressure and volume balanced.

Flow/Mounting details



Accessories

Mechanical accessories	Description	Type
	Fixing bracket for 6-way valve DN 15/20	ZR-004

Dimensions

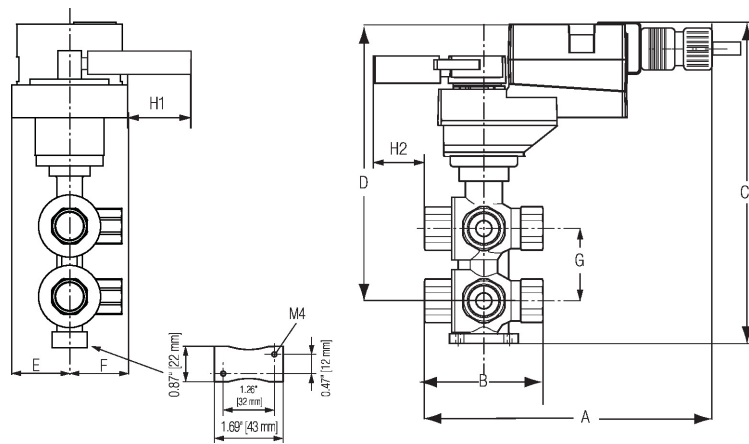

A	B	C	D	E	F	G	H1	H2
7.5" [191]	3.9" [100]	9.0" [229]	7.6" [194]	2.0" [51]	2.0" [51]	2.4" [60]	1.2" [30]	0.6" [15]



5-year warranty



Technical data

Electrical data	Nominal voltage	AC/DC 24 V
	Nominal voltage frequency	50/60 Hz
	Power consumption in operation	1.5 W
	Power consumption in rest position	0.4 W
	Power consumption for wire sizing	3 VA
	Transformer sizing	3 VA (class 2 power source)
	Electrical Connection	18 GA plenum cable, 3 ft [1 m], with 1/2" conduit connector
	Overload Protection	electronic throughout 0...90° rotation
Functional data	Operating range Y	2...10 V
	Operating range Y note	4...20 mA w/ ZG-R01 (500 Ω, 1/4 W resistor)
	Input Impedance	100 kΩ for 2...10 V (0.1 mA), 500 Ω for 4...20 mA
	Position feedback U	2...10 V
	Position feedback U note	Max. 1 mA
	Direction of motion motor	selectable with switch 0/1
	Manual override	external push button
	Angle of rotation	90°
	Angle of rotation note	adjustable with mechanical stop
	Running Time (Motor)	90 s / 90°
	Noise level, motor	35 dB(A)
	Position indication	Mechanically, pluggable
Safety data	Degree of protection IEC/EN	IP54
	Degree of protection NEMA/UL	NEMA 2
	Enclosure	UL Enclosure Type 2
	Agency Listing	cULus acc. to UL60730-1A/-2-14, CAN/CSA E60730-1:02, CE acc. to 2014/30/EU Listed to UL 2043 - suitable for use in air plenums per Section 300.22(C) of the NEC and Section 602 of the IMC
	Quality Standard	ISO 9001
	Ambient temperature	-22...122°F [-30...50°C]
	Storage temperature	-40...176°F [-40...80°C]
	Ambient humidity	Max. 95% RH, non-condensing
	Servicing	maintenance-free
	Materials	Housing material

Footnotes †Rated Impulse Voltage 800V, Type action 1.B, Control Pollution Degree 3.

Product features

Mode of operation Local Control SY2~12, 24vac Mod

Home position

Accessories

Electrical accessories	Description	Type
	Battery backup system, for non-spring return models	NSV24 US
	Battery, 12 V, 1.2 Ah (two required)	NSV-BAT
	Auxiliary switch 1 x SPDT add-on	S1A
	Auxiliary switch 2 x SPDT add-on	S2A
	Feedback potentiometer 140 Ω add-on, grey	P140A GR
	Feedback potentiometer 1 kΩ add-on, grey	P1000A GR
	Feedback potentiometer 10 kΩ add-on, grey	P10000A GR
	Feedback potentiometer 2.8 kΩ add-on, grey	P2800A GR
	Feedback potentiometer 500 Ω add-on, grey	P500A GR
	Feedback potentiometer 5 kΩ add-on, grey	P5000A GR

Electrical installation

INSTALLATION NOTES

- Provide overload protection and disconnect as required.
- Actuators may be connected in parallel. Power consumption and input impedance must be observed.
- Actuators may also be powered by DC 24 V.
- Only connect common to negative (-) leg of control circuits.
- A 500 Ω resistor (ZG-R01) converts the 4...20 mA control signal to 2...10 V.
- Actuators with plenum cable do not have numbers; use color codes instead.
- Meets cULus requirements without the need of an electrical ground connection.
- Warning! Live electrical components!**
During installation, testing, servicing and troubleshooting of this product, it may be necessary to work with live electrical components. Have a qualified licensed electrician or other individual who has been properly trained in handling live electrical components perform these tasks. Failure to follow all electrical safety precautions when exposed to live electrical components could result in death or serious injury.

Wiring diagrams

2...10 V / 4...20 mA Control

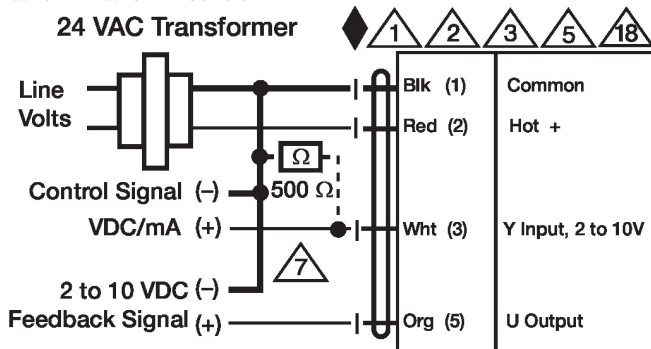

Dimensions