



5-year warranty



Technical data

Functional data	Valve Size	1.25" [32]
	Fluid	chilled or hot water, up to 60% glycol
	Fluid Temp Range (water)	0...250°F [-18...120°C]
	Body Pressure Rating	400 psi
	Close-off pressure Δ ps	200 psi
	Flow characteristic	A-port equal percentage, B-port modified for constant common port flow
	Servicing	maintenance-free
	Flow Pattern	3-way Mixing/Diverting
	Leakage rate	0% for A – AB, <2.0% for B – AB
	Controllable flow range	75°
	Cv	19
	Body pressure rating note	400 psi
	Cv Flow Rating	A-port: as stated in chart B-port: 70% of A – AB Cv
Materials	Valve body	Nickel-plated brass body
	Stem seal	EPDM (lubricated)
	Seat	PTFE
	Pipe connection	NPT female ends
	O-ring	EPDM (lubricated)
	Ball	stainless steel
Suitable actuators	Non-Spring	ARB(X)

Safety notes



- **WARNING:** This product can expose you to lead which is known to the State of California to cause cancer and reproductive harm. For more information go to www.p65warnings.ca.gov

Product features

- Application** This valve is typically used in air handling units on heating or cooling coils, and fan coil unit heating or cooling coils. Some other common applications include Unit Ventilators, VAV box re-heat coils and bypass loops. This valve is suitable for use in a hydronic system with variable or constant flow.

Flow/Mounting details



Dimensions

Dimensional drawings



ARB, ARX

A	B	C	D	E	F	H1	H2
10.0" [254]	4.0" [101]	6.8" [172]	5.5" [140]	1.7" [44]	2.1" [54]	0.8" [20]	0.6" [15]

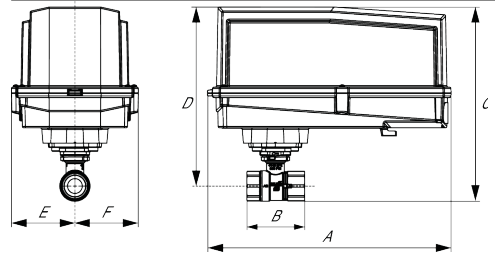

ARB N4, ARX N4, NRB N4, NRX N4

A	B	C	D	E	F
11.4" [289]	4.0" [101]	8.9" [226]	7.6" [194]	3.1" [80]	3.1" [80]

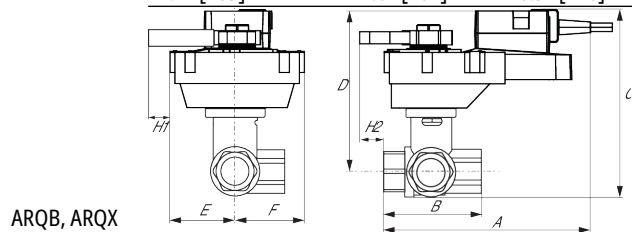

ARQB, ARQX

A	B	C	D	E	F	H1	H2
9.7" [246]	4.0" [101]	7.5" [191]	6.2" [158]	1.7" [44]	2.1" [54]	1.4" [34]	0.8" [20]

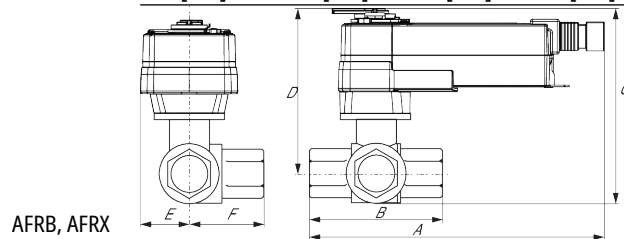

AFRB, AFRX

A	B	C	D	E	F
10.6" [269]	4.0" [101]	6.9" [175]	5.7" [146]	2.1" [54]	1.3" [33]

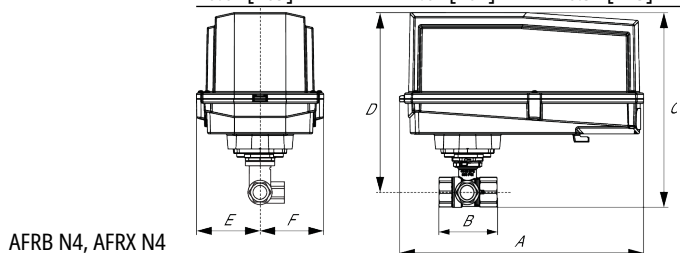

AFRB N4, AFRX N4

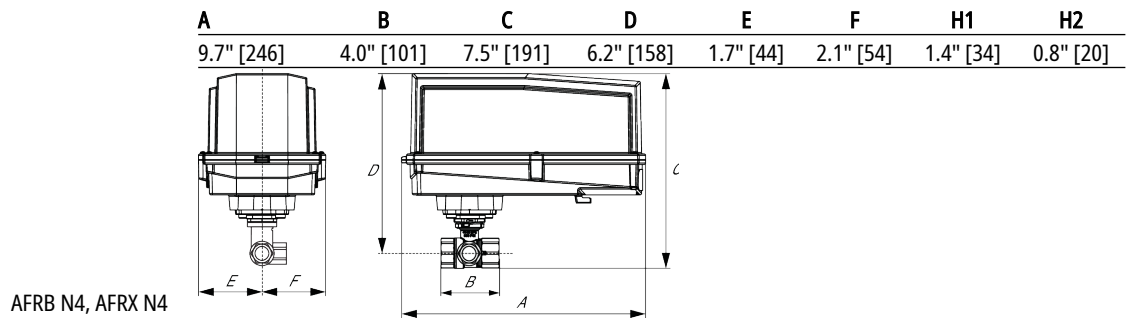
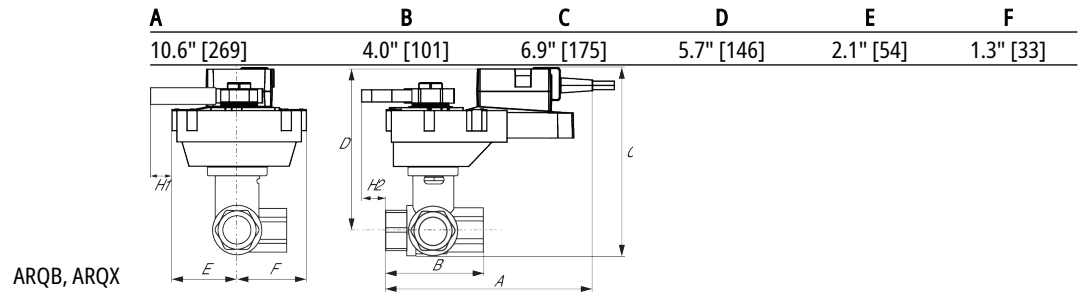
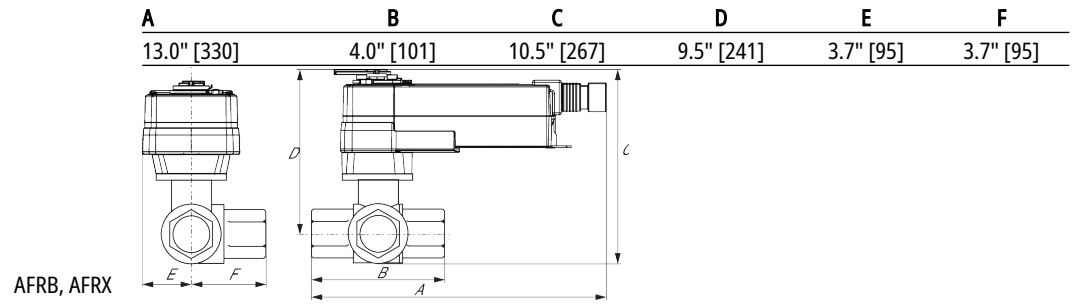

A	B	C	D	E	F
13.0" [330]	4.0" [101]	10.5" [267]	9.5" [241]	3.7" [95]	3.7" [95]



5-year warranty



Technical data

Electrical data	Nominal voltage	AC/DC 24 V
	Nominal voltage frequency	50/60 Hz
	Power consumption in operation	7.5 W
	Power consumption in rest position	3 W
	Transformer sizing	10 VA (class 2 power source)
	Auxiliary switch	2 x SPDT, 3 A resistive (0.5 A inductive) @ AC 250 V, one set at 10°, one adjustable 10...90°
	Switching capacity auxiliary switch	3 A resistive (0.5 A inductive) @ AC 250 V
	Electrical Connection	(2) 18 GA appliance cables with 1/2" conduit connectors, 3 ft [1 m],
	Overload Protection	electronic throughout 0...95° rotation
Functional data	Operating range Y	2...10 V
	Operating range Y note	4...20 mA w/ ZG-R01 (500 Ω, 1/4 W resistor)
	Input Impedance	100 kΩ for 2...10 V (0.1 mA), 500 Ω for 4...20 mA, 1500 Ω for PWM, On/Off and Floating point
	Operating range Y variable	Start point 0.5...30 V End point 2.5...32 V
	Options positioning signal	variable (VDC, PWM, on/off, floating point)
	Position feedback U	2...10 V
	Position feedback U note	Max. 0.5 mA
	Position feedback U variable	VDC variable
	Direction of motion motor	selectable with switch
	Direction of motion fail-safe	reversible with cw/ccw mounting
	Manual override	5 mm hex crank (3/16" Allen), supplied
	Angle of rotation	90°
	Running Time (Motor)	default 150 s, variable 70...220 s
	Running time motor variable	70...220 s
	Running time fail-safe	<20 s $t_{amb} = 68^{\circ}\text{F} [20^{\circ}\text{C}]$
	Angle of rotation adaptation	off (default)
	Override control	MIN (minimum position) = 0% MID (intermediate position) = 50% MAX (maximum position) = 100%
	Noise level, motor	45 dB(A)
	Noise level, fail-safe	62 dB(A)
	Position indication	Mechanical
Safety data	Degree of protection IEC/EN	IP54
	Degree of protection NEMA/UL	NEMA 2 UL Enclosure Type 2

Agency Listing	cULus acc. to UL60730-1A/-2-14, CAN/CSA E60730-1:02, CE acc. to 2014/30/EU and 2014/35/EU; Listed to UL 2043 - suitable for use in air plenums per Section 300.22(c) of the NEC and Section 602.2 of the IMC
Quality Standard	ISO 9001
Ambient temperature	-22...122°F [-30...50°C]
Storage temperature	-40...176°F [-40...80°C]
Ambient humidity	max. 95% r.H., non-condensing
Servicing	maintenance-free
Weight	Weight 4.2 lb [1.9 kg]

Accessories

Gateways	Description	Type
	Gateway MP to BACnet MS/TP	UK24BAC
	Gateway MP to LonWorks	UK24LON
	Gateway MP to Modbus RTU	UK24MOD
Service tools	Description	Type
	Connection cable 10 ft [3 m], A: RJ11 6/4 ZTH EU, B: 3-pin Weidmüller and supply connection	ZK4-GEN
	Service Tool, with ZIP-USB function, for parametrisable and communicative Belimo actuators, VAV controller and HVAC performance devices	ZTH US

Electrical installation
✂ INSTALLATION NOTES

- (A)** Actuators with appliance cables are numbered.
- 1** Provide overload protection and disconnect as required.
- 3** Actuators may also be powered by 24 VDC.
- 4** Two built-in auxiliary switches (2x SPDT), for end position indication, interlock control, fan startup, etc.
- 5** Only connect common to negative (-) leg of control circuits.
- 7** A 500 Ω resistor (ZG-R01) converts the 4...20 mA control signal to 2...10 V.
- 8** Control signal may be pulsed from either the Hot (Source) or Common (Sink) 24 V line.
- 10** For triac sink the Common connection from the actuator must be connected to the Hot connection of the controller. Position feedback cannot be used with a triac sink controller; the actuator internal common reference is not compatible.
- 46** Actuators may be controlled in parallel. Current draw and input impedance must be observed.
- 47** Master-Slave wiring required for piggy-back applications. Feedback from Master to control input(s) of Slave(s).
- ◆** Meets cULus requirements without the need of an electrical ground connection.
- ⚠ Warning! Live Electrical Components!**
During installation, testing, servicing and troubleshooting of this product, it may be necessary to work with live electrical components. Have a qualified licensed electrician or other individual who has been properly trained in handling live electrical components perform these tasks. Failure to follow all electrical safety precautions when exposed to live electrical components could result in death or serious injury.
- ⚠** Apply only AC line voltage or only UL-Class 2 voltage to the terminals of auxiliary switches. Mixed or combined operation of line voltage/safety extra low voltage is not allowed.

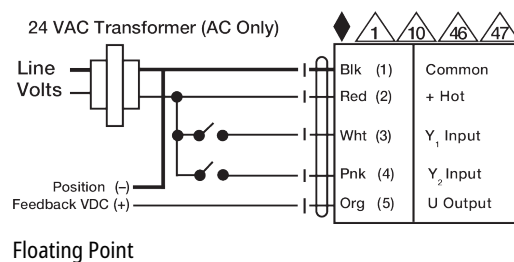
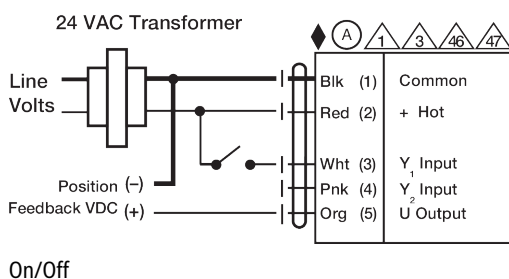

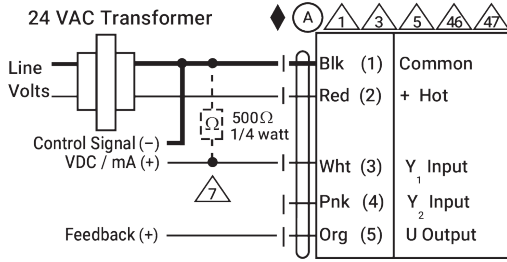

VDC/mA Control

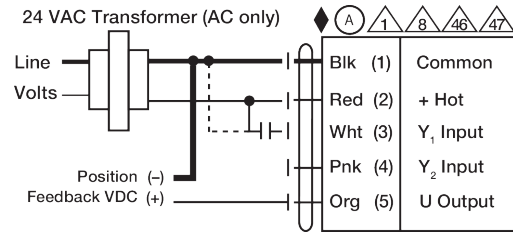

PWM Control

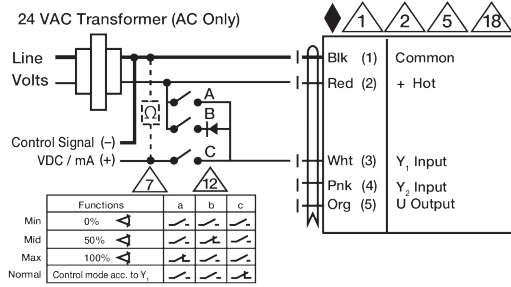

Override Control

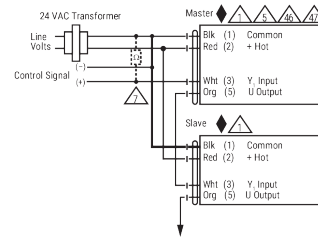

Master - Slave

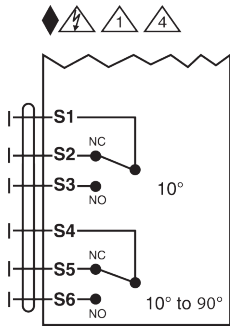

Auxiliary Switches