

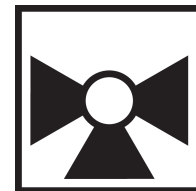

5-year warranty



Technical data

Functional data	Valve Size	1.25" [32]
	Fluid	chilled or hot water, up to 60% glycol
	Fluid Temp Range (water)	0...250°F [-18...120°C]
	Body Pressure Rating	400 psi
	Close-off pressure Δ ps	200 psi
	Flow characteristic	A-port equal percentage, B-port modified for constant common port flow
	Servicing	maintenance-free
	Flow Pattern	3-way Mixing/Diverting
	Leakage rate	0% for A – AB, <2.0% for B – AB
	Controllable flow range	75°
	Cv	25
	Body pressure rating note	400 psi
	Cv Flow Rating	A-port: as stated in chart B-port: 70% of A – AB Cv
Materials	Valve body	Nickel-plated brass body
	Stem seal	EPDM (lubricated)
	Seat	PTFE
	Pipe connection	NPT female ends
	O-ring	EPDM (lubricated)
	Ball	stainless steel
Suitable actuators	Non-Spring	ARB(X)

Safety notes



- **WARNING:** This product can expose you to lead which is known to the State of California to cause cancer and reproductive harm. For more information go to www.p65warnings.ca.gov

Product features

- Application** This valve is typically used in air handling units on heating or cooling coils, and fan coil unit heating or cooling coils. Some other common applications include Unit Ventilators, VAV box re-heat coils and bypass loops. This valve is suitable for use in a hydronic system with variable or constant flow.

Flow/Mounting details



Dimensions

Dimensional drawings



ARB, ARX

A	B	C	D	E	F	H1	H2
10.0" [254]	4.0" [101]	6.8" [172]	5.5" [140]	1.7" [44]	2.1" [54]	0.8" [20]	0.6" [15]

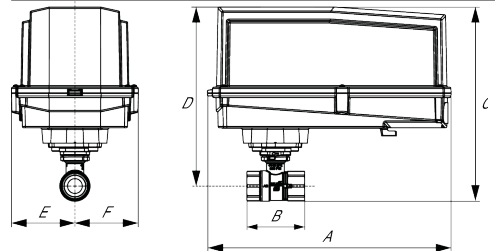

ARB N4, ARX N4, NRB N4, NRX N4

A	B	C	D	E	F
11.4" [289]	4.0" [101]	8.9" [226]	7.6" [194]	3.1" [80]	3.1" [80]



ARQB, ARQX

A	B	C	D	E	F	H1	H2
9.7" [246]	4.0" [101]	7.5" [191]	6.2" [158]	1.7" [44]	2.1" [54]	1.4" [34]	0.8" [20]



AFRB, AFRX

A	B	C	D	E	F
10.6" [269]	4.0" [101]	6.9" [175]	5.7" [146]	2.1" [54]	1.3" [33]

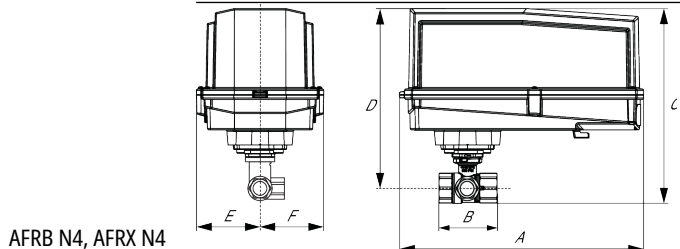

AFRB N4, AFRX N4

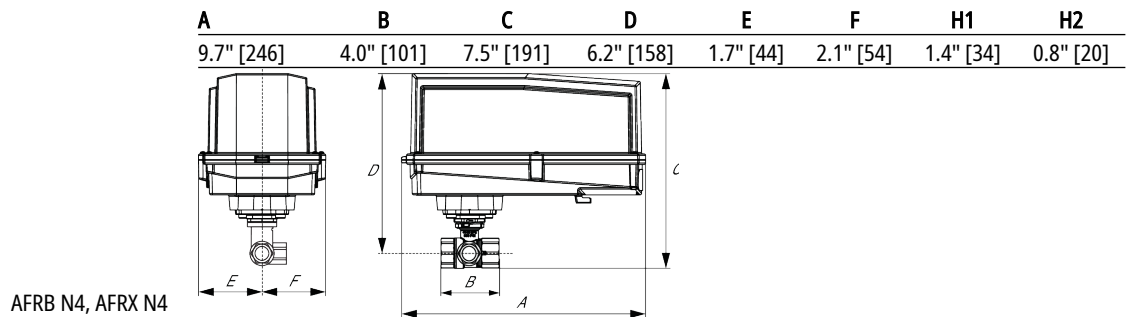
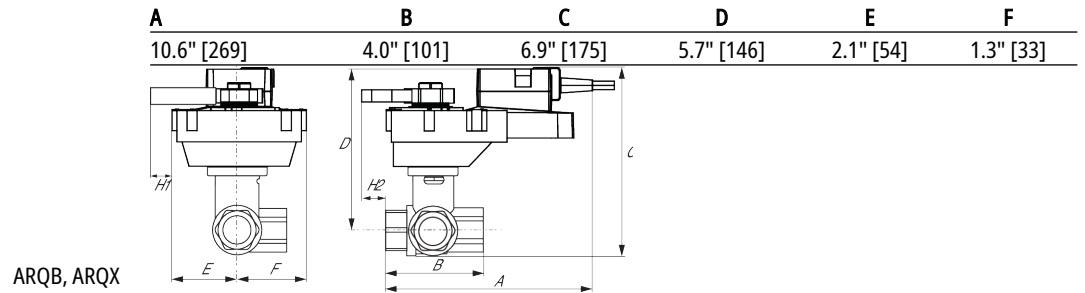
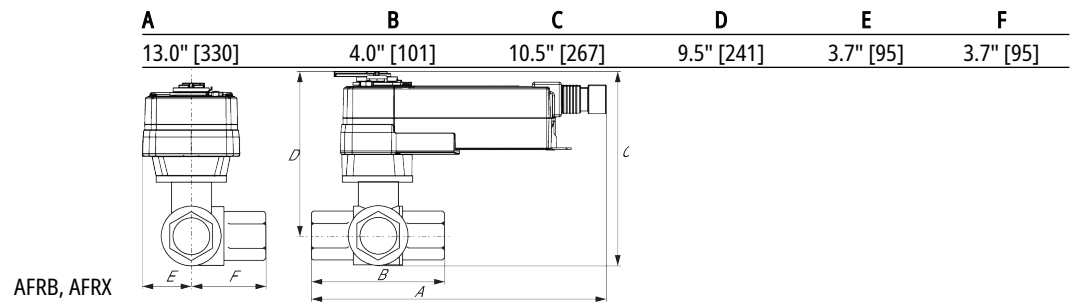

A	B	C	D	E	F
13.0" [330]	4.0" [101]	10.5" [267]	9.5" [241]	3.7" [95]	3.7" [95]



5-year warranty



Technical data

Electrical data	Nominal voltage	AC 24...240 V / DC 24...125 V
	Nominal voltage frequency	50/60 Hz
	Power consumption in operation	7 W
	Power consumption in rest position	3.5 W
	Transformer sizing	7 VA @ AC 24 V (class 2 power source), 8.5 VA @ AC 120 V, 18 VA @ AC 240 V
	Electrical Connection	18 GA appliance cable, 3 ft [1 m], with 1/2" conduit connector
	Overload Protection	electronic throughout 0...95° rotation
Functional data	Direction of motion motor	selectable by ccw/cw mounting
	Direction of motion fail-safe	reversible with cw/ccw mounting
	Manual override	5 mm hex crank (3/16" Allen), supplied
	Angle of rotation	90°
	Running Time (Motor)	75 s
	Running time fail-safe	<20 s t _{amb} = 68°F [20°C]
	Noise level, motor	45 dB(A)
	Noise level, fail-safe	62 dB(A)
Position indication	Mechanical	
Safety data	Degree of protection IEC/EN	IP54
	Degree of protection NEMA/UL	NEMA 2 UL Enclosure Type 2
	Agency Listing	cULus acc. to UL60730-1A/-2-14, CAN/CSA E60730-1:02, CE acc. to 2014/30/EU and 2014/35/EU; Listed to UL 2043 - suitable for use in air plenums per Section 300.22(c) of the NEC and Section 602.2 of the IMC
	Quality Standard	ISO 9001
	Ambient temperature	-22...122°F [-30...50°C]
	Storage temperature	-40...176°F [-40...80°C]
	Ambient humidity	max. 95% r.H., non-condensing
	Servicing	maintenance-free
Weight	Weight	4.1 lb [1.9 kg]

Electrical installation

INSTALLATION NOTES

- Actuators with appliance cables are numbered.
- Universal Power Supply (UP) models can be supplied with 24 VAC up to 240 VAC, or 24 VDC up to 125 VDC.
- Provide overload protection and disconnect as required.
- Actuators may be powered in parallel. Power consumption must be observed.

Parallel wiring required for piggy-back applications.

Meets cULus requirements without the need of an electrical ground connection.

Warning! Live Electrical Components!

During installation, testing, servicing and troubleshooting of this product, it may be necessary to work with live electrical components. Have a qualified licensed electrician or other individual who has been properly trained in handling live electrical components perform these tasks. Failure to follow all electrical safety precautions when exposed to live electrical components could result in death or serious injury.

