



5-year warranty



Technical data

Functional data	Valve Size	1.5" [40]
	Fluid	chilled or hot water, up to 60% glycol
	Fluid Temp Range (water)	0...250°F [-18...120°C]
	Body Pressure Rating	400 psi
	Close-off pressure Δps	200 psi
	Flow characteristic	A-port equal percentage, B-port modified for constant common port flow
	Servicing	maintenance-free
	Flow Pattern	3-way Mixing/Diverting
	Leakage rate	0% for A – AB, <2.0% for B – AB
	Controllable flow range	75°
	Cv	46
	Body pressure rating note	400 psi
	Cv Flow Rating	A-port: as stated in chart B-port: 70% of A – AB Cv
Materials	Valve body	Nickel-plated brass body
	Stem seal	EPDM (lubricated)
	Seat	PTFE
	Pipe connection	NPT female ends
	O-ring	EPDM (lubricated)
	Ball	stainless steel
Suitable actuators	Non-Spring	ARB(X)

Safety notes



- **WARNING:** This product can expose you to lead which is known to the State of California to cause cancer and reproductive harm. For more information go to www.p65warnings.ca.gov

Product features

- Application** This valve is typically used in air handling units on heating or cooling coils, and fan coil unit heating or cooling coils. Some other common applications include Unit Ventilators, VAV box re-heat coils and bypass loops. This valve is suitable for use in a hydronic system with variable or constant flow.

Flow/Mounting details



Dimensions

Dimensional drawings



ARB, ARX

A	B	C	D	E	F	H1	H2
10.0" [254]	4.4" [112]	7.2" [184]	5.7" [146]	1.7" [44]	2.3" [58]	0.8" [20]	0.6" [15]



ARB N4, ARX N4

A	B	C	D	E	F
11.4" [289]	4.4" [112]	9.3" [236]	7.8" [198]	3.1" [80]	3.1" [80]



ARQB, ARQX

A	B	C	D	E	F	H1	H2
9.9" [251]	4.4" [112]	7.8" [199]	6.3" [161]	2.3" [58]	2.3" [58]	0.8" [20]	0.8" [20]



AFRB, AFRX

A	B	C	D	E	F
10.8" [275]	4.4" [112]	7.9" [201]	6.4" [162]	2.3" [58]	2.3" [58]



AFRB N4, AFRX N4

A	B	C	D	E	F
13.0" [330]	4.4" [112]	11.2" [284]	9.7" [246]	3.7" [95]	3.7" [95]
A	B	C	D	E	F
10.8" [275]	4.4" [112]	7.9" [201]	6.4" [162]	2.3" [58]	2.3" [58]

ARQB, ARQX

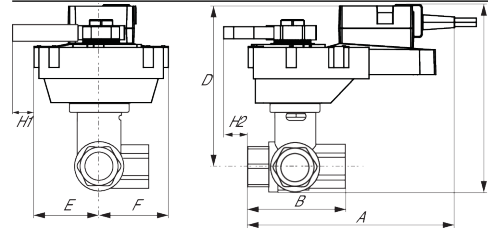

A	B	C	D	E	F	H1	H2
9.9" [251]	4.4" [112]	7.8" [199]	6.3" [161]	2.3" [58]	2.3" [58]	0.8" [20]	0.8" [20]

AFRB N4, AFRX N4

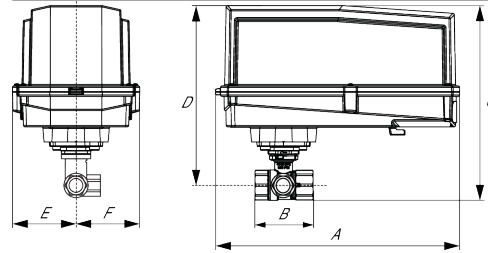

A	B	C	D	E	F
13.0" [330]	4.4" [112]	11.2" [284]	9.7" [246]	3.7" [95]	3.7" [95]



5-year warranty



Technical data

Electrical data	Nominal voltage	AC/DC 24 V	
	Nominal voltage frequency	50/60 Hz	
	Power consumption in operation	7.5 W	
	Power consumption in rest position	3 W	
	Transformer sizing	10 VA (class 2 power source)	
	Electrical Connection	18 GA appliance cable, 3 ft [1 m], with 1/2" conduit connector	
	Overload Protection	electronic throughout 0...95° rotation	
Functional data	Operating range Y	0...135 Ω	
	Operating range Y note	Honeywell Electronic Series 90, input 0...135 Ω	
	Position feedback U	2...10 V	
	Position feedback U note	Max. 0.5 mA	
	Position feedback U variable	VDC variable	
	Direction of motion motor	selectable with switch	
	Direction of motion fail-safe	reversible with cw/ccw mounting	
	Manual override	5 mm hex crank (3/16" Allen), supplied	
	Angle of rotation	90°	
	Running Time (Motor)	default 150 s, variable 70...220 s	
	Running time motor variable	70...220 s	
	Running time fail-safe	<20 s tamb = 68°F [20°C]	
	Angle of rotation adaptation	off (default)	
	Position indication	Mechanical	
Safety data	Degree of protection IEC/EN	IP54	
	Degree of protection NEMA/UL	NEMA 2 UL Enclosure Type 2	
	Agency Listing	cULus acc. to UL60730-1A/-2-14, CAN/CSA E60730-1:02, CE acc. to 2014/30/EU and 2014/35/EU; Listed to UL 2043 - suitable for use in air plenums per Section 300.22(c) of the NEC and Section 602.2 of the IMC	
	Quality Standard	ISO 9001	
	Ambient temperature	-22...122°F [-30...50°C]	
	Storage temperature	-40...176°F [-40...80°C]	
	Ambient humidity	max. 95% r.H., non-condensing	
	Servicing	maintenance-free	
	Weight	Weight	4.1 lb [1.9 kg]
		Materials	Housing material Galvanized steel and plastic housing

Gateways	Description	Type
	Gateway MP to BACnet MS/TP	UK24BAC
	Gateway MP to LonWorks	UK24LON
	Gateway MP to Modbus RTU	UK24MOD
Service tools	Description	Type
	Connection cable 10 ft [3 m], A: RJ11 6/4 ZTH EU, B: 3-pin Weidmüller and supply connection	ZK4-GEN
	Service Tool, with ZIP-USB function, for parametrisable and communicative Belimo actuators, VAV controller and HVAC performance devices	ZTH US

Electrical installation

✂ INSTALLATION NOTES

- 1 Provide overload protection and disconnect as required.
- 3 Actuators may also be powered by 24 VDC.
- 22 Actuators and controller must have separate transformers.
- 23 Consult controller instruction data for more detailed information.
- 24 Resistor value depends on the type of controller and the number of actuators. No resistor is used for one actuator. Honeywell® resistor kits may also be used.
- 25 To reverse control rotation, use the reversing switch.
- 46 Actuators may be controlled in parallel. Current draw and input impedance must be observed.
- ◆ Meets cULus requirements without the need of an electrical ground connection.
- ! **Warning! Live Electrical Components!**

During installation, testing, servicing and troubleshooting of this product, it may be necessary to work with live electrical components. Have a qualified licensed electrician or other individual who has been properly trained in handling live electrical components perform these tasks. Failure to follow all electrical safety precautions when exposed to live electrical components could result in death or serious injury.

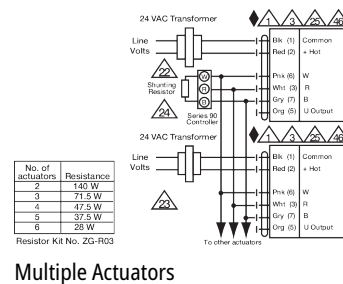
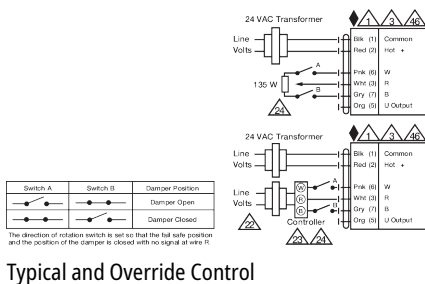
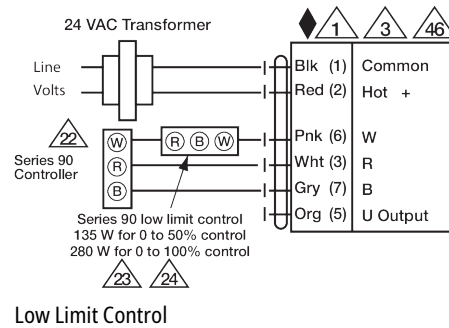
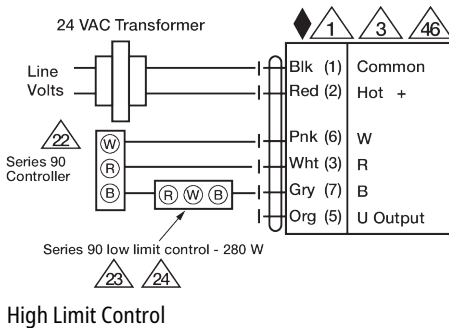

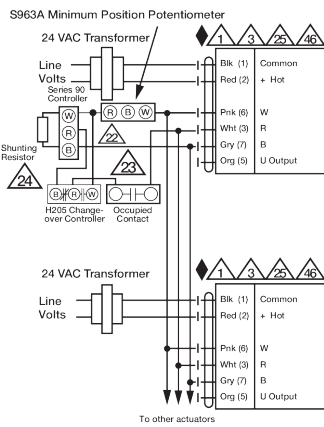

Multiple Actuators with Minimum Position Potentiometer

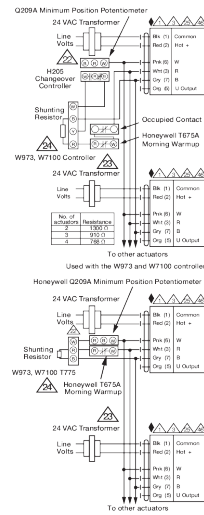

Multiple Actuators Used with W973, W7100 and T775