



5-year warranty



Technical data

<b>Functional data</b>	Valve Size	2" [50]
	Fluid	chilled or hot water, up to 60% glycol
	Fluid Temp Range (water)	0...250°F [-18...120°C]
	Body Pressure Rating	400 psi
	Body pressure rating note	400 psi
	Close-off pressure Δps	200 psi
	Flow characteristic	A-port equal percentage, B-port modified for constant common port flow
	Servicing	maintenance-free
	Flow Pattern	3-way Mixing/Diverting
	Leakage rate	0% for A – AB, <2.0% for B – AB
	Controllable flow range	75°
	Cv	57
	Cv Flow Rating	A-port: as stated in chart B-port: 70% of A – AB Cv
<b>Materials</b>	Valve body	Nickel-plated brass body
	Stem	stainless steel
	Stem seal	EPDM (lubricated)
	Seat	PTFE
	Characterizing disk	TEFZEL®
	Pipe connection	NPT female ends
	O-ring	EPDM (lubricated)
	Ball	stainless steel
<b>Suitable actuators</b>	Non-Spring	ARB(X)
	Spring	AF

Safety notes



- WARNING: This product can expose you to lead which is known to the State of California to cause cancer and reproductive harm. For more information go to [www.p65warnings.ca.gov](http://www.p65warnings.ca.gov)

Product features

**Application** This valve is typically used in air handling units on heating or cooling coils, and fan coil unit heating or cooling coils. Some other common applications include Unit Ventilators, VAV box re-heat coils and bypass loops. This valve is suitable for use in a hydronic system with variable or constant flow.

Flow/Mounting details



Dimensions

Dimensional drawings



Type	DN	Weight [kg]
B350	50	2.5

A	B	C	D	E	F	H1
10.5" [267]	4.9" [125]	7.7" [196]	6.0" [152]	1.7" [44]	2.6" [66]	0.8" [20]

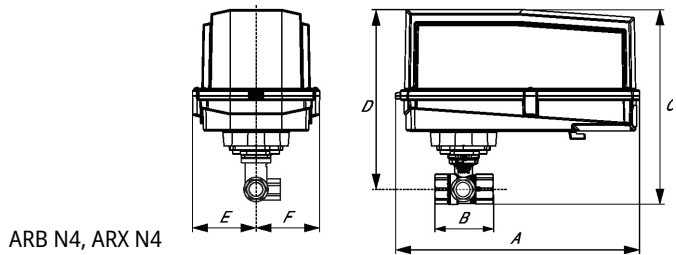

A	B	C	D	E	F
11.4" [289]	4.9" [125]	9.8" [249]	8.0" [203]	3.1" [80]	3.1" [80]

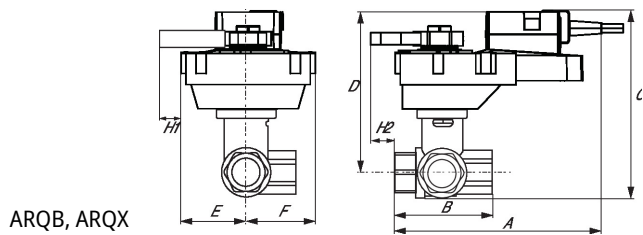

A	B	C	D	E	F	H1	H2
9.9" [251]	4.9" [125]	8.3" [211]	6.6" [168]	2.3" [58]	2.6" [66]	0.8" [20]	0.6" [15]

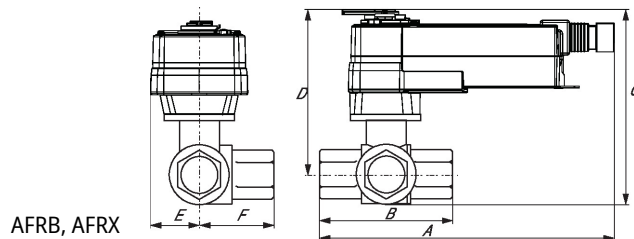

A	B	C	D	E	F
11.3" [286]	4.9" [125]	8.3" [211]	6.6" [168]	2.6" [66]	2.6" [66]

AFRB N4, AFRX N4



A	B	C	D	E	F
13.0" [330]	4.9" [125]	11.8" [300]	9.9" [251]	3.7" [95]	3.7" [95]



5-year warranty



Technical data

<b>Electrical data</b>	Nominal voltage	AC/DC 24 V
	Nominal voltage frequency	50/60 Hz
	Power consumption in operation	2.5 W
	Power consumption in rest position	0.5 W
	Transformer sizing	5.5 VA (class 2 power source)
	Electrical Connection	18 GA plenum cable with 1/2" conduit connector, degree of protection NEMA 2 / IP54, 3 ft [1 m] 10 ft [3 m] and 16ft [5 m]
	Overload Protection	electronic throughout 0...90° rotation
<b>Functional data</b>	Direction of motion motor	selectable with switch 0/1
	Manual override	external push button
	Angle of rotation	90°
	Angle of rotation note	adjustable with mechanical stop
	Running Time (Motor)	default 90 s, variable 90 or 150 s
	Running time motor variable	90 or 150 s
	Noise level, motor	45 dB(A)
Position indication	Mechanically, pluggable	
<b>Safety data</b>	Degree of protection IEC/EN	IP54
	Degree of protection NEMA/UL	NEMA 2
	Enclosure	UL Enclosure Type 2
	Agency Listing	cULus acc. to UL60730-1A/-2-14, CAN/CSA E60730-1:02, CE acc. to 2014/30/EU and 2014/35/EU; Listed to UL 2043 - suitable for use in air plenums per Section 300.22(c) of the NEC and Section 602.2 of the IMC
	Quality Standard	ISO 9001
	Ambient temperature	-22...122°F [-30...50°C]
	Storage temperature	-40...176°F [-40...80°C]
	Ambient humidity	Max. 95% RH, non-condensing
	Servicing	maintenance-free
	<b>Weight</b>	Weight

Accessories

Electrical accessories	Description	Type
	Battery backup system, for non-spring return models	NSV24 US
	Battery, 12 V, 1.2 Ah (two required)	NSV-BAT

Electrical installation

**✂ INSTALLATION NOTES**

- ⚠ Provide overload protection and disconnect as required.
- ⚠ Actuators may be connected in parallel. Power consumption and input impedance must be observed.
- ⚠ Actuators may also be powered by DC 24 V.
- ⚠ Actuators Hot wire must be connected to the control board common. Only connect common to neg. (-) leg of control circuits. Terminal models (-T) have no-feedback.
- ⚠ Actuators with plenum cable do not have numbers; use color codes instead.
- ◆ Meets cULus requirements without the need of an electrical ground connection.
- ⚠ **Warning! Live electrical components!**

During installation, testing, servicing and troubleshooting of this product, it may be necessary to work with live electrical components. Have a qualified licensed electrician or other individual who has been properly trained in handling live electrical components perform these tasks. Failure to follow all electrical safety precautions when exposed to live electrical components could result in death or serious injury.

**Wiring diagrams**

On/Off

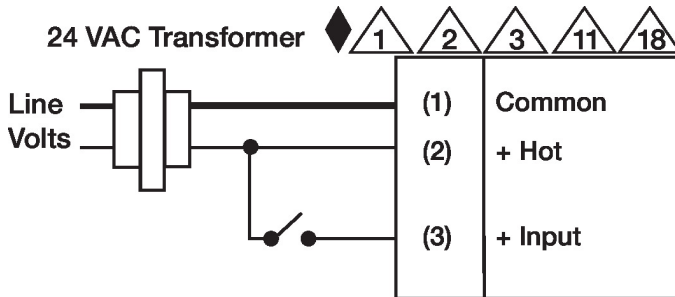

Floating Point

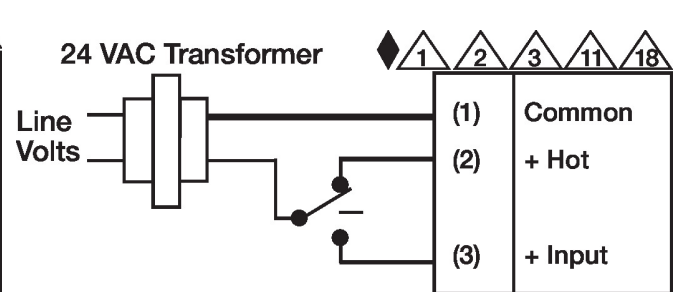

**24 VAC Transformer**

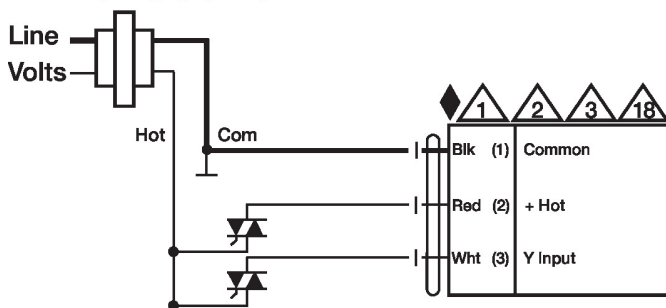

Floating Point - Triac Sink

**24 VAC Transformer**

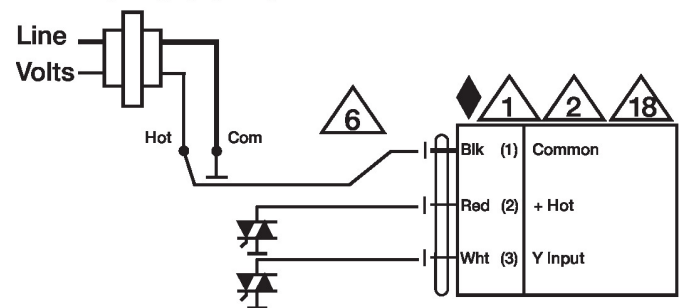

Dimensions

