

2-year warranty

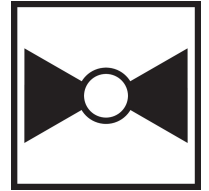

Technical data

Functional data	Valve Size	12" [300]
	Fluid	chilled or hot water, up to 60% glycol, steam
	Fluid Temp Range (water)	-22...380°F [-30...193°C]
	Fluid Temp Range (steam)	-22...365°F [-30...185°C]
	Body Pressure Rating	ANSI Class 150
	Close-off pressure Δps	250 psi
	Flow characteristic	equal percentage
	Servicing	repack/rebuild kits available
	Rangeability Sv	300:1
	Maximum differential pressure (water)	150 psi
	Max Differential Pressure (Steam)	100 psi
	Close-Off Pressure (Steam)	150 psi
	Flow Pattern	2-way
	Leakage rate	ANSI Class IV
	Controllable flow range	75°
	Cv	1905
	Maximum Inlet Pressure (Steam)	150 psi
Materials	Valve body	WCC grade carbon steel
	Body finish	matt black body finish
	Stem	stainless steel
	Stem seal	PTFE V-ring
	Seat	PTFE
	Pipe connection	125/150 lb flanged, ASME/ANSI b16.1/b16.5
	Ball	stainless steel
Suitable actuators	Non-Spring	SY4

Product features

Product features Fast quarter turn open or closed operation, stainless-steel ball and stem, positive isolation, two-piece body construction

Application This valve is typically used in air handling units on heating or cooling coils, and fan coil unit heating or cooling coils. Some other common applications include Unit Ventilators, VAV box re-heat coils and bypass loops. This valve is suitable for use in a hydronic system with variable flow.

Flow/Mounting details

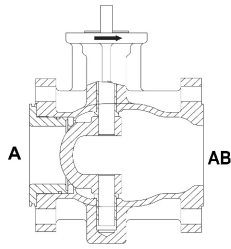



2-year warranty

Technical data

Electrical data	Nominal voltage	AC 120 V
	Nominal voltage frequency	50/60 Hz
	Transformer sizing	253 VA
	Current consumption	2.1 A
	Auxiliary switch	2 x SPDT, 3 A resistive (0.5 A inductive) @ AC 250 V, one set at 10°, one set at 85°
	Switching capacity auxiliary switch	3 A resistive (0.5 A inductive) @ AC 250 V
	Electrical Connection	Terminal blocks
	Overload Protection	thermally protected 135°C cut-out
	Internal Humidity Control	resistive heating element
Functional data	Position feedback U variable	VDC variable
	Direction of motion motor	selectable with switch 0/1
	Manual override	hand wheel
	Angle of rotation	90°
	Running Time (Motor)	24 s
	Duty cycle value	75%
	Noise level, motor	45 dB(A)
	Position indication	top mounted domed indicator
Safety data	Degree of protection IEC/EN	IP66/67
	Degree of protection NEMA/UL	NEMA 4X
	Enclosure	UL Enclosure Type 4X
	Agency Listing	ISO, CE, cCSAus
	Quality Standard	ISO 9001
	Ambient temperature	-22...149°F [-30...65°C]
	Storage temperature	-40...176°F [-40...80°C]
	Ambient humidity	Max. 100% RH
	Servicing	maintenance-free
Weight	Weight	49 lb [22 kg]
Materials	Housing material	die cast aluminium
	Gear train	high alloy steel gear sets, self locking

Product features

Application SY Series actuators are fractional horsepower devices, and utilize full-wave power supplies. Observe wire sizing and transformer sizing requirements. Proportional models CANNOT be connected to Belimo direct coupled (AF, AM, GM...etc) actuator power supplies or any type of half-wave device. You MUST use a separate, dedicated transformer or power supply to power the SY actuator. Please do not connect other automation equipment to the dedicated SY supply source. You MUST use four wires (plus a ground) to control a proportional control SY actuator (See SY Wiring Section).

Accessories

Gateways	Description	Type
	Gateway MP to BACnet MS/TP	UK24BAC
	Gateway MP to LonWorks	UK24LON
	Gateway MP to Modbus RTU	UK24MOD
Electrical accessories	Description	Type
	Battery backup system for SY4...6 series actuator, AC 120 V, on/off	EXT-NSV-B03-120
	Local electric disconnect for SY4...12 series actuator, AC 120 V, MFT	HOA-120VMFT
	Service Tool, with ZIP-USB function, for programmable and communicative Belimo actuators, VAV controller and HVAC performance devices	ZTH US
Service tools	Description	Type
	Connection cable 10 ft [3 m], A: RJ11 6/4 ZTH EU, B: 3-pin Weidmüller and supply connection	ZK4-GEN
	Service Tool, with ZIP-USB function, for programmable and communicative Belimo actuators, VAV controller and HVAC performance devices	ZTH US

Electrical installation

INSTALLATION NOTES

- Do not change sensitivity or dip switch setting with power applied.
- Power supply Common/Neutral and Control Signal "-" wiring to a common is prohibited. Terminals 4 and 6 need to be wired separately.
- Isolation relays must be used in parallel connection of multiple actuators using a common control signal inputs. The relays should be DPDT.
- Isolation relays are required in parallel applications. The reason parallel applications need isolation relays is that the motor uses two sets of windings, one for each direction. When one is energized to turn the actuator in a specific direction a voltage is generated in the other due to the magnetic field created from the first. It's called back EMF. This is not an issue with one actuator because the voltage generated in the second winding isn't connected to anything so there is no flow. On parallel applications without isolation, this EMF voltage energizes the winding it is connected to on the other actuators in the system, the actuators are trying to turn in both directions at once. The EMF voltage is always less than the supply voltage due to the resistance of the windings, so while the actuator still turns in the commanded direction, the drag from the other reduces the torque output and causes overheating.
- Warning! Live electrical components!**
During installation, testing, servicing and troubleshooting of this product, it may be necessary to work with live electrical components. Have a qualified licensed electrician or other individual who has been properly trained in handling live electrical components perform these tasks. Failure to follow all electrical safety precautions when exposed to live electrical components could result in death or serious injury.

Wiring diagrams

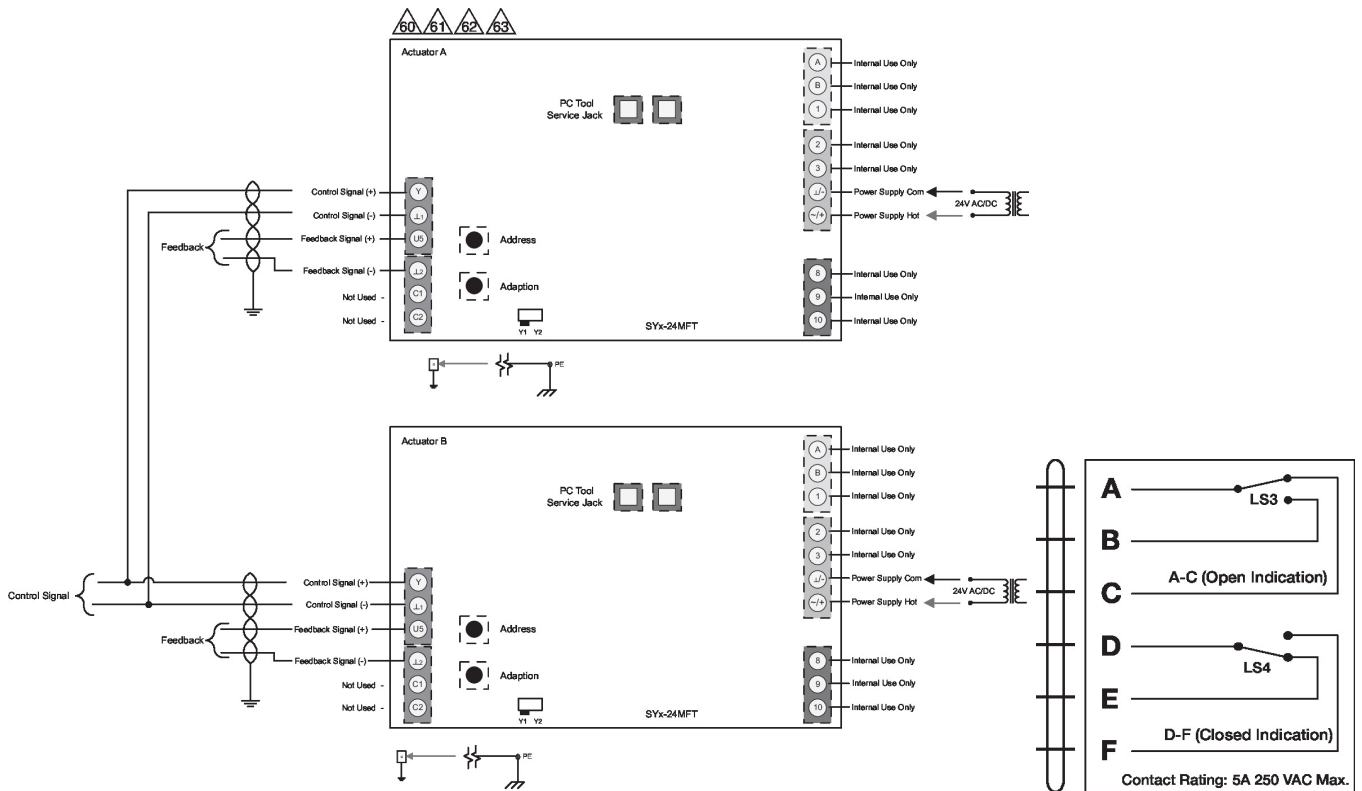
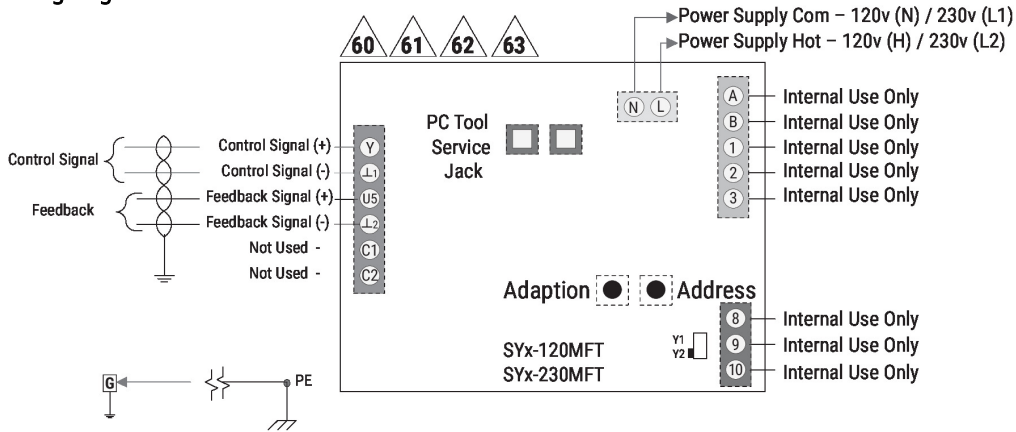

Installation notes

Servicing

Negative torque Weathershield for VS/VSS (LM/NM/LF)