



5-year warranty

Type overview

Type	DN
F650-300SHP	50

Technical data

Functional data	Valve Size	2" [50]
	Fluid	chilled or hot water, up to 60% glycol, steam
	Fluid Temp Range (water)	-22...400°F [-30...204°C]
	Body Pressure Rating	ANSI Class 300
	Close-off pressure Δps	285 psi
	Flow characteristic	modified equal percentage, unidirectional
	Servicing	maintenance-free
	Flow Pattern	2-way
	Leakage rate	0%
	Controllable flow range	quarter turn, mechanically limited
	Cv	102
	Maximum Inlet Pressure (Steam)	50 psi
	Maximum Velocity	32 FPS
	Lug threads	5/8-11 UNC
Materials	Valve body	Carbon steel full lug (ASME B16.34)
	Stem	17-4 PH stainless steel
	Seat	RPTFE
	Pipe connection	ASME/ANSI class 300 flange
	Bearing	glass backed PTFE
	Disc	316 stainless steel
	Gland Seal	TFE
	Gear operator materials	Gears - hardened steel
Suitable actuators	Non-Spring	GMB(X) (2*GMB(X)) PRB(X)
	Electrical fail-safe	(2*GKB(X)) PKRB(X)

Safety notes



- WARNING: This product can expose you to lead which is known to the State of California to cause cancer and reproductive harm. For more information go to www.p65warnings.ca.gov

Product features

Flow/Mounting details

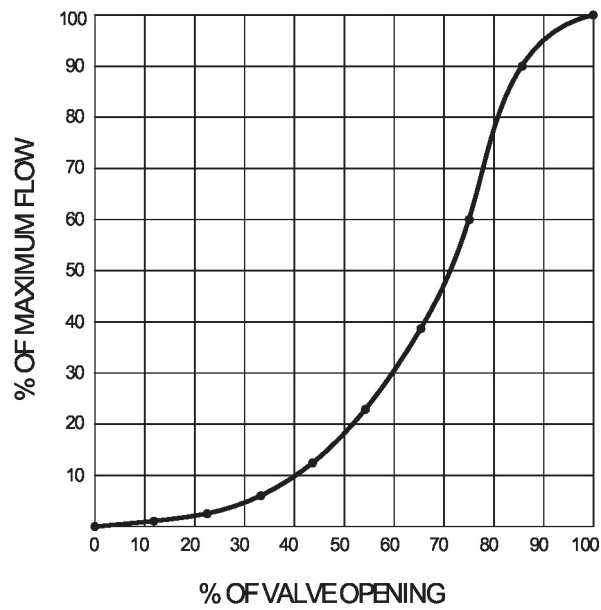

Dimensions

Type	DN
F650-300SHP	50

2*GM/2*GK

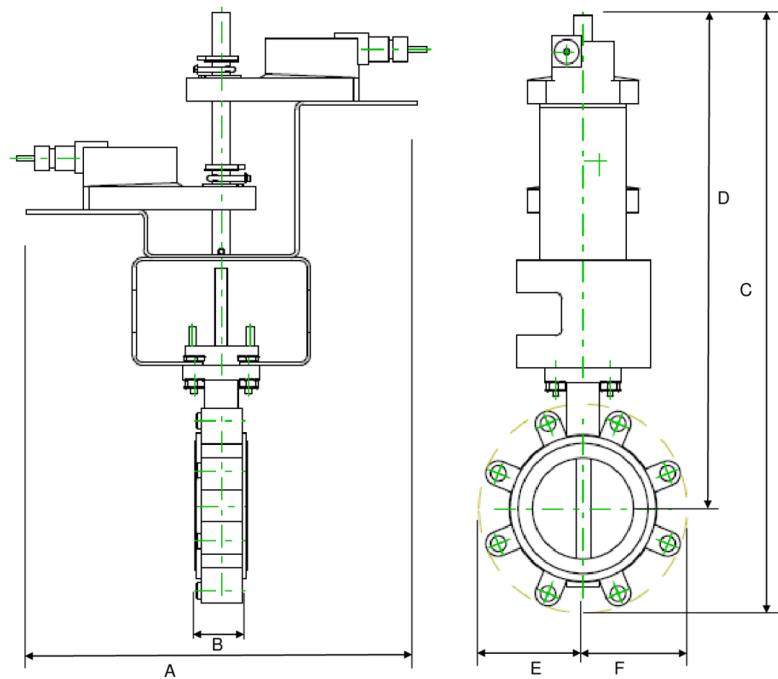

A	B	C	D	E	F	Number of Bolt Holes
18.0" [457]	1.8" [45]	20.0" [509]	17.0" [431]	2.9" [73]	2.9" [73]	8

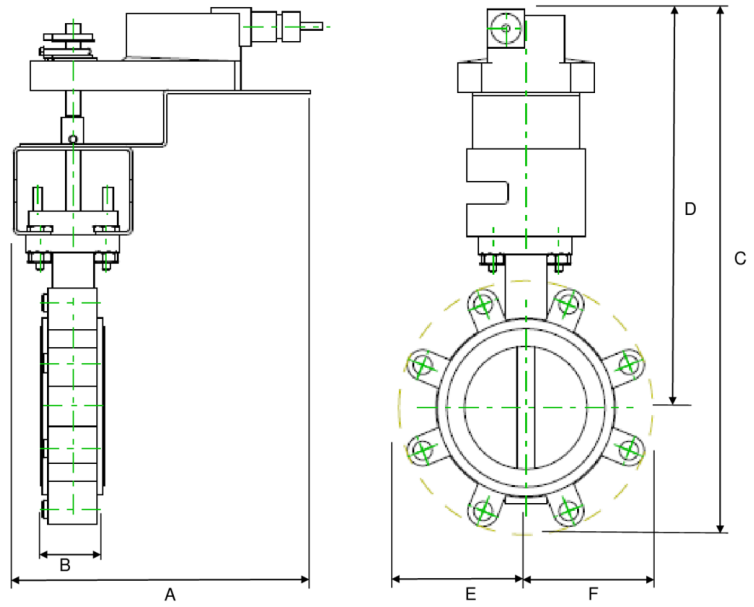

GM/GK

A	B	C	D	E	F	Number of Bolt Holes
15.3" [388]	1.8" [45]	15.3" [389]	11.5" [292]	3.9" [100]	3.9" [100]	8

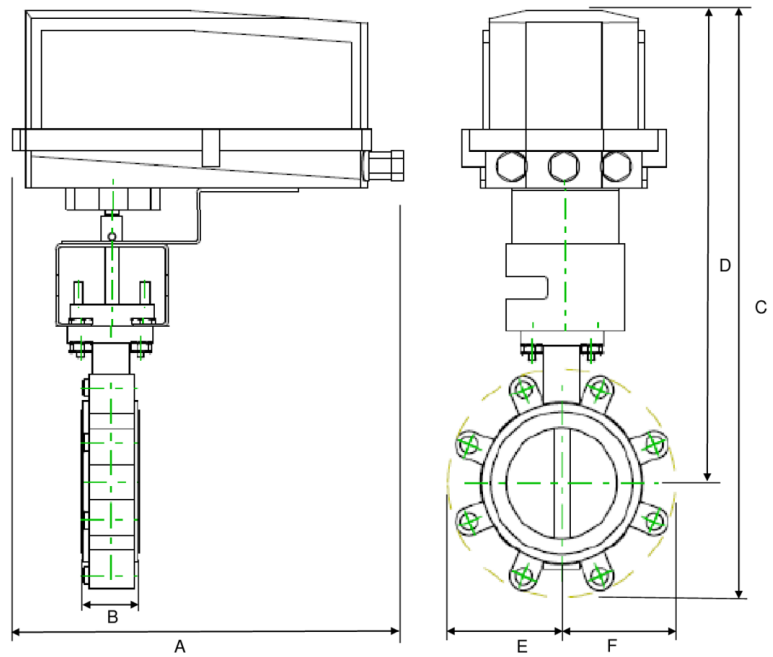

GK/GM N4

A	B	C	D	E	F	Number of Bolt Holes
10.9" [277]	1.8" [45]	17.2" [438]	12.5" [318]	4.9" [124]	4.9" [125]	8

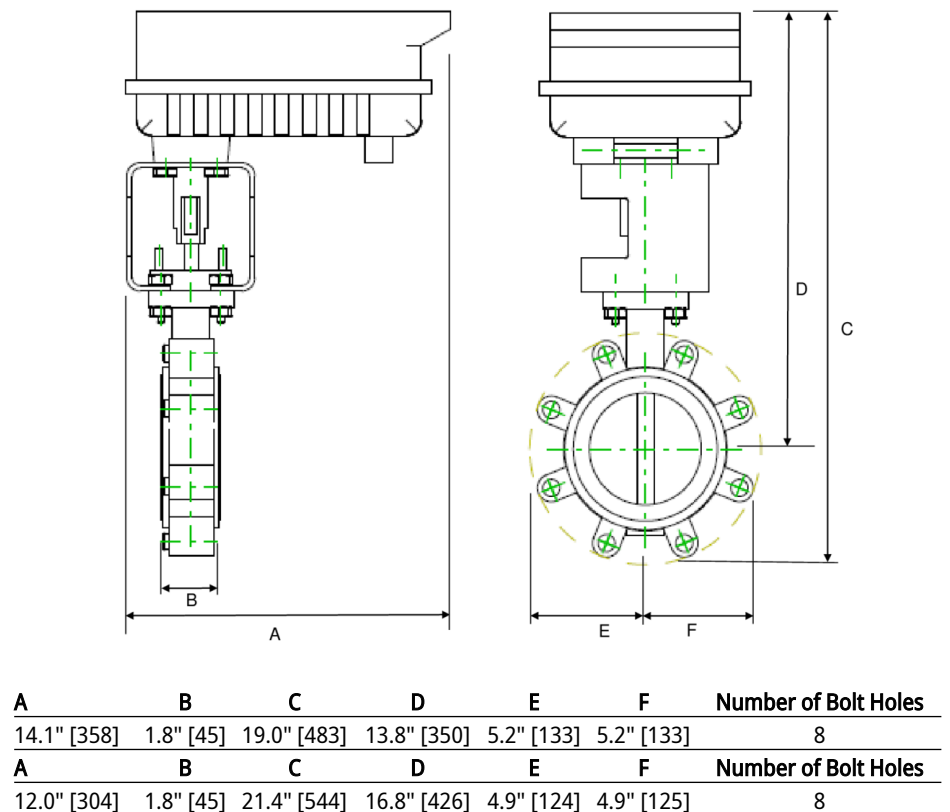
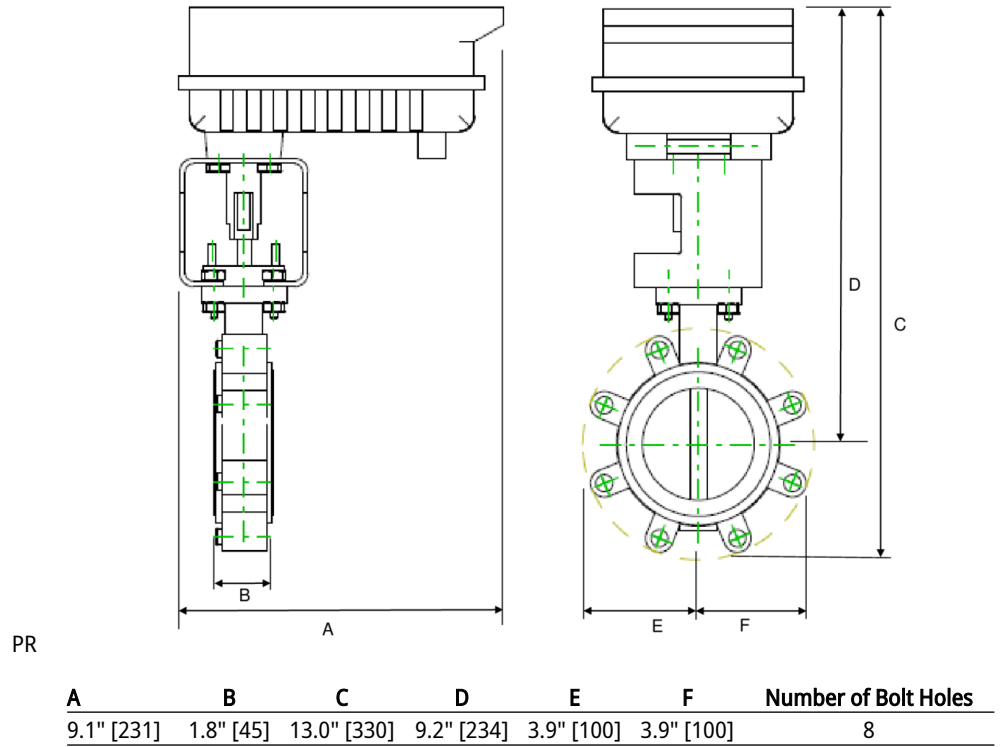



5-year warranty



Technical data

Electrical data	Nominal voltage	AC/DC 24 V
	Nominal voltage frequency	50/60 Hz
	Power consumption in operation	8 W
	Power consumption in rest position	2.5 W
	Transformer sizing	11 VA (class 2 power source)
	Electrical Connection	Terminal blocks
	Overload Protection	electronic throughout 0...95° rotation
Functional data	Direction of motion motor	selectable with switch 0/1
	Manual override	under cover
	Angle of rotation	Max. 95°
	Angle of rotation note	adjustable with mechanical stop
	Running Time (Motor)	35 s / 90°
	Running time motor note	constant, independent of load
	Noise level, motor	45 dB(A)
	Position indication	Mechanically, 5...20 mm stroke
Safety data	Degree of protection IEC/EN	IP66/67
	Degree of protection NEMA/UL	NEMA 4X
	Enclosure	UL Enclosure Type 4X
	Agency Listing	cULus acc. to UL60730-1A/-2-14, CAN/CSA E60730-1:02, CE acc. to 2014/30/EU and 2014/35/EU
	Quality Standard	ISO 9001
	Ambient temperature	-22...122°F [-30...50°C]
	Ambient temperature note	-40...50°C for actuator with integrated heating
	Storage temperature	-40...176°F [-40...80°C]
	Ambient humidity	Max. 100% RH
	Servicing	maintenance-free
Materials	Housing material	Die cast aluminium and plastic casing

Footnotes †Rated Impulse Voltage 800V, Type action 1, Control Pollution Degree 3.

Accessories

Electrical accessories	Description	Type
	Battery backup system, for non-spring return models	NSV24 US
	Battery, 12 V, 1.2 Ah (two required)	NSV-BAT

Electrical installation

✂ INSTALLATION NOTES

- 1** Provide overload protection and disconnect as required.
- 3** Actuators may also be powered by DC 24 V.
- 10** For triac sink the Common connection from the actuator must be connected to the Hot connection of the controller. Position feedback cannot be used with a triac sink controller; the actuator internal common reference is not compatible.
- 12** IN4004 or IN4007 diode. (IN4007 supplied, Belimo part number 40155).
- 16** Actuators are provided with a numbered screw terminal strip instead of a cable.
- ◆ Meets cULus requirements without the need of an electrical ground connection.
- 1** **Warning! Live electrical components!**
During installation, testing, servicing and troubleshooting of this product, it may be necessary to work with live electrical components. Have a qualified licensed electrician or other individual who has been properly trained in handling live electrical components perform these tasks. Failure to follow all electrical safety precautions when exposed to live electrical components could result in death or serious injury.

Wiring diagrams

On/Off

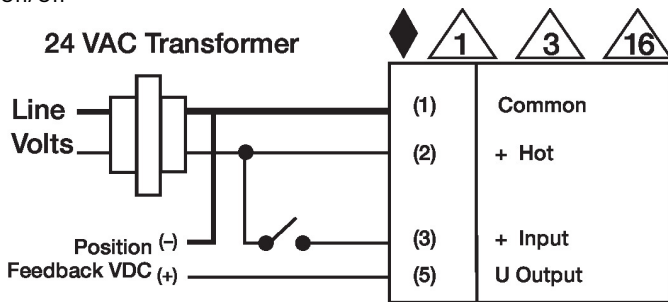

Floating Point

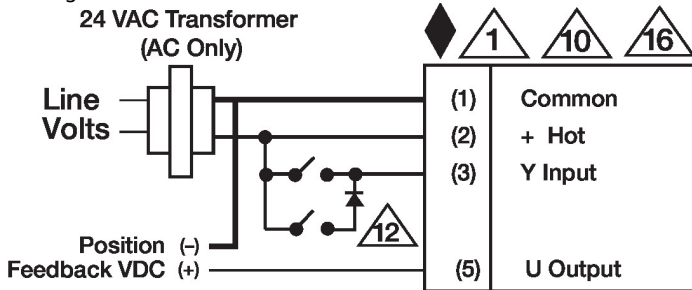

Dimensions