

- Torque 20 Nm /
- Nominal voltage AC 230 V
- Control On/Off



5-year warranty



Technical data

Electrical data	Nominal voltage	AC 230 V
	Nominal voltage frequency	50/60 Hz
	Power consumption in operation	37 VA
	Power consumption in rest position	10 W, 19 VA (60 Hz 12 VA), End stop 54 VA, 0.25 A slow blow fuse *
	Auxiliary switch	2 x SPST, 6 A resistive (2.5 A inductive) @ AC 250 V, one set at 5°, one set at 85°
	Switching capacity auxiliary switch	6 A resistive (2.5 A inductive) @ AC 250 V
	Electrical Connection	18 GA appliance cable, 3 ft [1 m], with 1/2" conduit connector
	Overload Protection	electronic throughout 0...95° rotation
	Electrical Protection	grounded enclosure, 230 V
Functional data	Torque motor	180 in-lb [20 Nm]
	Direction of motion motor	selectable by ccw/cw mounting
	Direction of motion fail-safe	reversible with cw/ccw mounting
	Angle of rotation	95°
	Running Time (Motor)	25 s / 90°
	Running time fail-safe	<15 s
	Noise level, motor	70 dB(A)
	Noise level, fail-safe	73 dB(A)
	Shaft Diameter	1/2...1.05" round, centers on 3/4" with insert, 1.05" without insert
Position indication	Mechanical	
Safety data	Degree of protection IEC/EN	IP40
	Degree of protection NEMA/UL	NEMA 1
	Enclosure	UL Enclosure Type 1
	Agency Listing	cULus listed to UL60730-1A:02; UL 60730-2-14:02 and CAN/CSA-E60730-1:02; Listed to UL 2043 - suitable for use in air plenums per Section 300.22(c) of the NEC and Section 602.2 of the IMC
	Quality Standard	ISO 9001, RoHS (EU-Directive 2011/65/EU)
	Ambient temperature	32...122°F [0...50°C]
	Storage temperature	-40...176°F [-40...80°C]
	Ambient humidity	Max. 95% RH, non-condensing
	Servicing	maintenance-free
Weight	Weight	7.0 lb [3.2 kg]
Materials	Housing material	galvanized steel
	Gears	steel, permanently lubricated

Footnotes † UL File XAPX.E108966

Safety notes



- * Neither UL nor Belimo require local over-current protection. The FSAF_A actuators draw higher peak current when driving against any type of stop. After 10 seconds current drops to the lower holding level. If used, this requires the value of a local fuse or breaker to be increased to avoid nuisance opening or tripping. A 2 A slow blow should be used for AC 24 V. A 0.5 A slow blow should be used for AC 120 V. A 0.25 A slow blow should be used for AC 230 V and a 0.3 A slow blow for AC 208 V.

Product features

- Application** The FS series of spring-return actuators are designed for the operation of UL555 and UL555S listed fire/smoke dampers in ventilation and air-conditioning systems.
- Operation** The actuator is mounted in its fail safe position with the damper blade(s) typically closed. Upon applying power, the actuator drives the damper to the open position. The internal spring is tensioned at the same time. If the power supply is interrupted, the spring moves the damper back to its fail-safe position.
- Typical specification** All smoke and combination fire and smoke dampers shall be provided with Belimo FSTF, FSLF, FSNF, or FSAF series actuators. All substitutions must be approved before submission of bid. Damper and actuator shall have UL555S Listing for 250°F and/or 350°F. Actuator shall have been tested to UL2043 per requirements of IMC 602.2 and NEC 300.22 (c). Where position indication is required -S models with auxiliary switches shall be provided.





Accessories

Electrical accessories	Description	Type
	Thermoelectric tripping device, Duct inside temperature 165°F	BAE165 US
	Auxiliary switch 2 x SPDT	S2A-F US
Mechanical accessories	Description	Type
	Anti-rotation bracket, for AF / NF	AF-P
	End stop indicator	IND-AFB
	Shaft clamp reversible, for central mounting, for damper shafts Ø12.7 / 19.0 / 25.4 mm	K7-2
	Ball joint suitable for damper crank arm KH8, Multipack 10 pcs.	KG8
	Actuator arm, for 3/4" shafts, clamping range Ø10...22 mm, Slot width 8.2 mm	KH-AFB
	Push rod for KG6 & KG8 ball joints (36" L, 5/16" diameter).	SH8
	Wrench 0.32 in and 0.39 in [8 mm and 10 mm]	TOOL-06
	<p>17" Mounting Bracket for AF,NF,GM,AM,SM</p>	ZG-100
	<p>Mounting Bracket: AF,NF,LF,GM,AM,NM,SM</p>	ZG-101
	Dual actuator mounting bracket.	ZG-102
	Weather shield 330x203x152 mm [13x8x6"] (LxBxH)	ZS-100
	Weather shield 406x213x102 mm [16x8-3/8x4"] (LxWxH)	ZS-150
	Explosion proof housing 406x254x164 mm [16x10x6.435"] (LxBxH), UL and CSA, Class I, Zone 1&2, Groups B, C, D, (NEMA 7), Class III, Hazardous (classified) Locations	ZS-260
	Weather shield 438x222x140 mm [17-1/4x8-3/4x5-1/2"] (LxBxH), NEMA 4X, with mounting brackets	ZS-300
	<p>FSAF*A series crankarm adaptor kit with ZG-108</p>	ZG-AFA108
	<p>Leg kit for FSAF*A series actuators</p>	ZG-AFA
	Damper clip for damper blade, 3.5" width.	ZG-DC1
	Damper clip for damper blade, 6" width.	ZG-DC2

Electrical installation



- 1 Provide overload protection and disconnect as required.
- 45 Actuators may be powered in parallel. Power consumption must be observed.

-  S4 makes to S6 when actuator is powered open.
-  Auxiliary switches are for end position indication or interlock control.
-  Double insulated.
-  Ground present on some models.

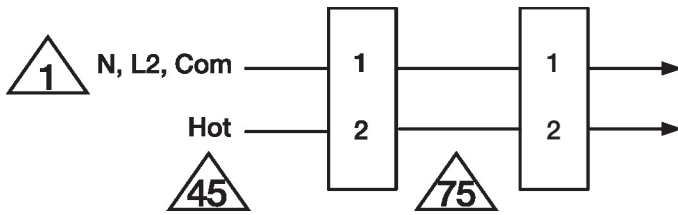

Parallel Actuator Wiring

Wiring diagrams

AC 230 V

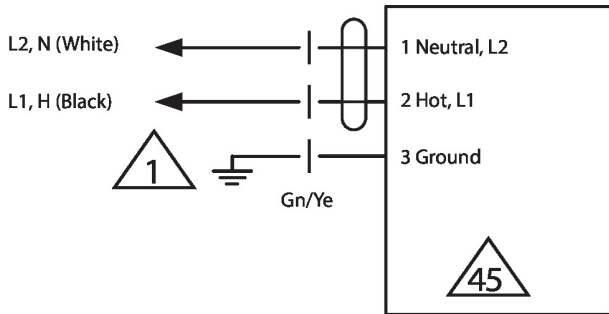

Typical containment damper control wiring
Detector or relay F&S Damper

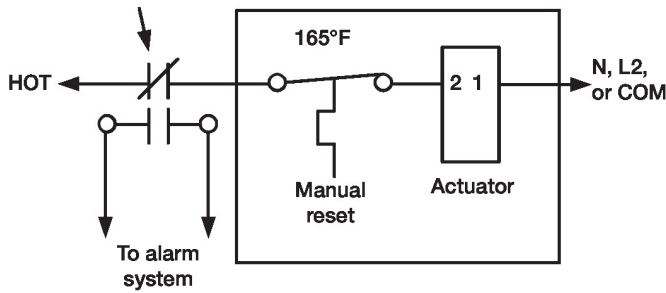

Parallel Actuator Wiring

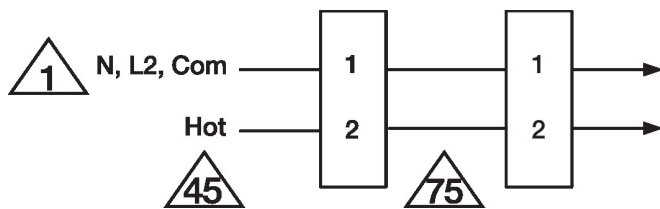

Auxiliary Switch Wiring

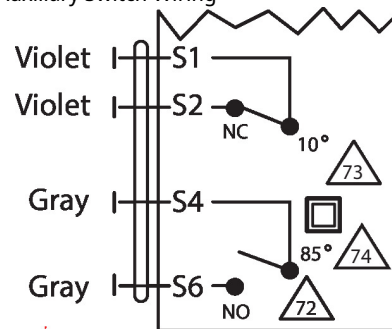

Dimensions

