

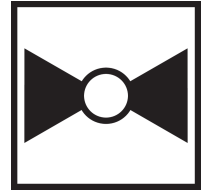

5-year warranty



Technical data

Functional data	Valve Size	5" [125]
	Fluid	chilled or hot water, up to 60% glycol, steam
	Fluid Temp Range (water)	32...350°F [0...176°C]
	Fluid Temp Range (steam)	32...338°F [0...170°C]
	Body Pressure Rating	ANSI Class 125, up to 175 psi below 150°F
	Flow characteristic	linear
	Servicing	repack/rebuild kits available
	Rangeability Sv	100:1
	Max Differential Pressure (Steam)	50 psi [345 kPa]
	Flow Pattern	2-way
	Leakage rate	ANSI Class III
	Controllable flow range	stem up - open A – AB
	Cv	263
	Maximum Inlet Pressure (Steam)	100 psi [690 kPa]
	ANSI Class	125
	Body pressure rating note	up to 175 psi below 150°F
Materials	Valve body	Cast iron - ASTM A126 Class B
	Valve plug	Stainless steel
	Stem seal	NLP EPDM (no lip packing)
	Seat	Stainless steel AISI 316
	Pipe connection	125 lb flanged
Suitable actuators	Non-Spring	EVb(X)
	Electronic fail-safe	AVKB(X)

Safety notes



- **WARNING:** This product can expose you to lead which is known to the State of California to cause cancer and reproductive harm. For more information go to www.p65warnings.ca.gov
- The valve has been designed for use in stationary heating, ventilation and air-conditioning systems and must not be used outside the specified field of application, especially in aircraft or in any other airborne means of transport.
- Only authorised specialists may carry out installation. All applicable legal or institutional installation regulations must be complied during installation.
- The valve does not contain any parts that can be replaced or repaired by the user.
- When determining the flow rate characteristic of controlled devices, the recognised directives must be observed.

Product features

Flow/Mounting details

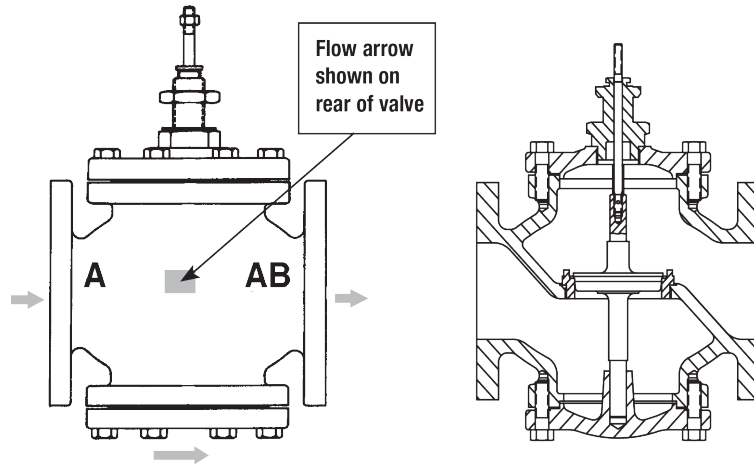

Dimensions

Dimensional drawings

EVB, EVX, RVB, RVX

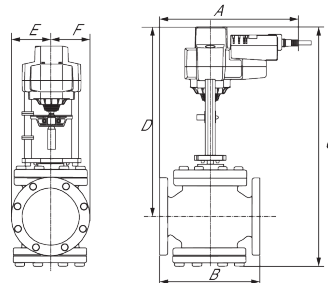

A	B	C	D	E	F	Number of Bolt Holes
15.1" [383]	15.7" [400]	25.4" [646]	17.5" [445]	5.0" [127]	5.0" [127]	8

2*AFB, 2*AFX

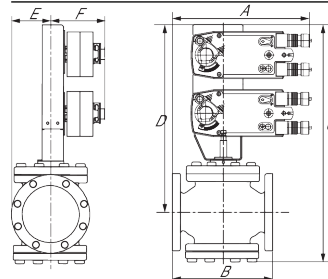

A	B	C	D	E	F	Number of Bolt Holes
15.1" [383]	15.7" [400]	28.7" [730]	21.0" [533]	5.0" [127]	5.3" [135]	8

AVKB, AVKX

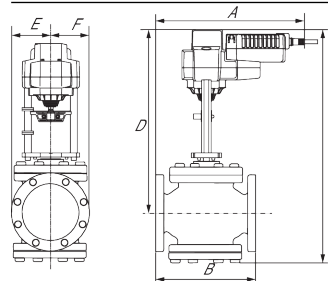

A	B	C	D	E	F	Number of Bolt Holes
15.1" [383]	15.7" [400]	25.4" [646]	17.5" [445]	5.0" [127]	5.0" [127]	8



5-year warranty



Technical data

Electrical data	Nominal voltage	AC 24 V
	Nominal voltage frequency	50/60 Hz
	Power consumption in operation	5 W
	Power consumption in rest position	2 W
	Transformer sizing	9.5 VA (class 2 power source)
	Electrical Connection	18 GA plenum cable, 3 ft [1 m], with 1/2" conduit connector, degree of protection NEMA 2 / IP54
	Overload Protection	electronic throughout full stroke
	Electrical Protection	actuators are double insulated
Functional data	Actuating force motor	450 lbf [2000 N]
	Input Impedance	100 kΩ (0.1 mA), 500 Ω, 1000 Ω (on/off)
	Position feedback U note	No Feedback
	Bridging time	2 s delay before fail-safe activates
	Pre-charging time	5...20 s
	Direction of motion motor	selectable with switch
	Direction of motion fail-safe	reversible with switch
	Manual override	5 mm hex crank (3/16" Allen), supplied
	Stroke	1.25" [32 mm]
	Running Time (Motor)	90 s, constant, independent of load
	Running time motor note	constant, independent of load
	Running time fail-safe	<35 s
	Noise level, motor	60 dB(A)
	Noise level, fail-safe	60 dB(A)
Position indication	Mechanically, with pointer	
Safety data	Degree of protection IEC/EN	IP54
	Degree of protection NEMA/UL	NEMA 2 UL Enclosure Type 2
	Agency Listing	cULus acc. to UL60730-1A/-2-14, CAN/CSA E60730-1:02, CE acc. to 2014/30/EU and 2014/35/EU
	Quality Standard	ISO 9001
	Ambient temperature	-22...122°F [-30...50°C]
	Storage temperature	-40...176°F [-40...80°C]
	Ambient humidity	max. 95% r.H., non-condensing
	Servicing	maintenance-free
Weight	Weight	6.39 lb [2.9 kg]
Materials	Housing material	Die cast aluminium and plastic casing

Safety notes



- PVC W/Shld for GV w/UGLK (GM)
- Battery Back Up System for SY(7~10)-110
- 120 to 24 VAC, 40 VA transformer.
- 50% voltage divider kit (resistors with wires).
- PC Tool computer programming interface, serial port.

Electrical installation

INSTALLATION NOTES

- ◆ Meets cULus requirements without the need of an electrical ground connection.
- △1 Provide overload protection and disconnect as required.
- △2 Actuators may be connected in parallel. Power consumption and input impedance must be observed.
- △8 Control signal may be pulsed from either the Hot (Source) or Common (Sink) 24 V line.
- △11 Actuators may be connected in parallel if not mechanically linked. Power consumption and input impedance must be observed.
- △18 Actuators with plenum cable do not have numbers; use color codes instead.
- △! **Warning! Live Electrical Components!**
During installation, testing, servicing and troubleshooting of this product, it may be necessary to work with live electrical components. Have a qualified licensed electrician or other individual who has been properly trained in handling live electrical components perform these tasks. Failure to follow all electrical safety precautions when exposed to live electrical components could result in death or serious injury.

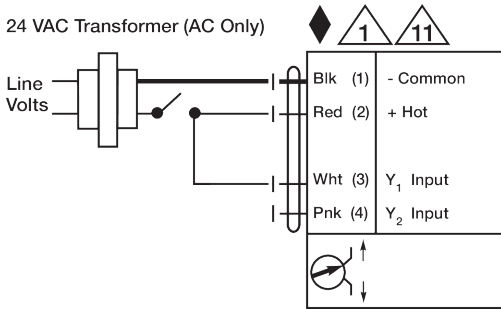

On/Off

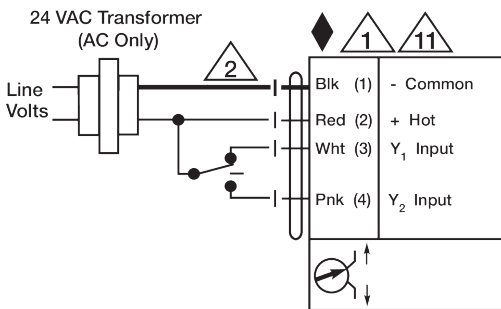

Floating Point