



5-year warranty



Technical data

Functional data	Valve Size	2.5" [65]
	Fluid	chilled or hot water, up to 60% glycol, steam
	Fluid Temp Range (water)	32...350°F [0...176°C]
	Fluid Temp Range (steam)	32...338°F [0...170°C]
	Body Pressure Rating	ANSI Class 125, up to 175 psi below 150°F
	Flow characteristic	equal percentage
	Servicing	repack/rebuild kits available
	Rangeability Sv	85:1
	Max Differential Pressure (Steam)	50 psi [345 kPa]
	Flow Pattern	2-way
	Leakage rate	ANSI Class III
	Controllable flow range	stem up - open A – AB
	Cv	65
	Maximum Inlet Pressure (Steam)	100 psi [690 kPa]
	ANSI Class	125
	Body pressure rating note	up to 175 psi below 150°F
Materials	Valve body	Cast iron - ASTM A126 Class B
	Valve plug	Stainless steel
	Stem seal	NLP EPDM (no lip packing)
	Seat	Stainless steel AISI 316
	Pipe connection	125 lb flanged
Suitable actuators	Non-Spring	EVb(X)
	Electronic fail-safe	AVKB(X)

Safety notes



- **WARNING:** This product can expose you to lead which is known to the State of California to cause cancer and reproductive harm. For more information go to www.p65warnings.ca.gov
- The valve has been designed for use in stationary heating, ventilation and air-conditioning systems and must not be used outside the specified field of application, especially in aircraft or in any other airborne means of transport.
- Only authorised specialists may carry out installation. All applicable legal or institutional installation regulations must be complied during installation.
- The valve does not contain any parts that can be replaced or repaired by the user.
- When determining the flow rate characteristic of controlled devices, the recognised directives must be observed.

Product features

Flow/Mounting details



Dimensions

Dimensional drawings

EVB, EVX, RVB, RVX



A	B	C	D	E	F	Number of Bolt Holes
11.7" [298]	9.0" [229]	23.0" [584]	18.3" [464]	3.6" [92]	3.6" [92]	4

AFB, AFX

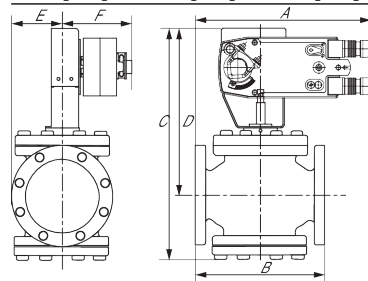

A	B	C	D	E	F	Number of Bolt Holes
11.7" [298]	9.0" [229]	21.7" [550]	16.9" [428]	3.6" [92]	5.3" [135]	4

AVKB, AVKX

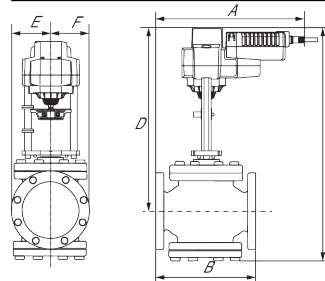

A	B	C	D	E	F	Number of Bolt Holes
11.7" [298]	9.0" [229]	23.0" [584]	18.3" [464]	3.6" [92]	3.6" [92]	4



5-year warranty



Technical data

Electrical data	Nominal voltage	AC/DC 24 V	
	Nominal voltage frequency	50/60 Hz	
	Power consumption in operation	7.5 W	
	Power consumption in rest position	3 W	
	Transformer sizing	10 VA (class 2 power source)	
	Electrical Connection	18 GA appliance cable, 3ft [1m] 10ft [3m] and 16ft [5m], with 1/2" conduit connector, degree of protection NEMA 2 / IP54	
	Overload Protection	electronic throughout 0...95° rotation	
Functional data	Operating range Y	0...135 Ω	
	Operating range Y note	Honeywell Electronic Series 90, input 0...135 Ω	
	Position feedback U	2...10 V	
	Position feedback U note	Max. 0.5 mA	
	Position feedback U variable	VDC variable	
	Direction of motion motor	selectable with switch 0/1	
	Manual override	5 mm hex crank (3/16" Allen), supplied	
	Angle of rotation	95°, adjustable with mechanical end stop, 35...95°	
	Angle of rotation note	adjustable with mechanical end stop, 35...95°	
	Running Time (Motor)	default 150 s, variable 70...220 s	
	Running time motor variable	70...220 s	
	Running time fail-safe	<20 s	
	Override control	MIN (minimum position) = 0% MID (intermediate position) = 50% MAX (maximum position) = 100%	
	Noise level, motor	40 dB(A)	
Noise level, fail-safe	62 dB(A)		
Position indication	Mechanical		
Safety data	Degree of protection IEC/EN	IP54	
	Degree of protection NEMA/UL	NEMA 2 UL Enclosure Type 2	
	Agency Listing	cULus acc. to UL60730-1A/-2-14, CAN/CSA E60730-1:02, CE acc. to 2014/30/EU	
	Quality Standard	ISO 9001	
	Ambient temperature	-22...122°F [-30...50°C]	
	Storage temperature	-40...176°F [-40...80°C]	
	Ambient humidity	max. 95% r.H., non-condensing	
	Servicing	maintenance-free	
	Weight	Weight	4.6 lb [2.1 kg]
		Materials	Housing material

Electrical installation

Warning! Live Electrical Components!

During installation, testing, servicing and troubleshooting of this product, it may be necessary to work with live electrical components. Have a qualified licensed electrician or other individual who has been properly trained in handling live electrical components perform these tasks. Failure to follow all electrical safety precautions when exposed to live electrical components could result in death or serious injury.

Meets cULus requirements without the need of an electrical ground connection.

1 Provide overload protection and disconnect as required.

3 Actuators may also be powered by 24 VDC.

22 Actuators and controller must have separate transformers.

23 Consult controller instruction data for more detailed information.

24 Resistor value depends on the type of controller and the number of actuators. No resistor is used for one actuator. Honeywell® resistor kits may also be used.

25 To reverse control rotation, use the reversing switch.

46 Actuators may be controlled in parallel. Current draw and input impedance must be observed.

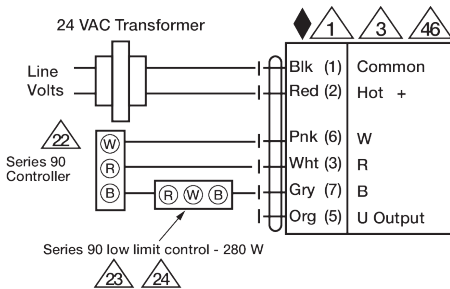

High Limit Control

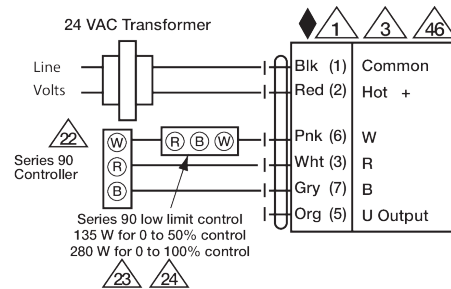

Low Limit Control

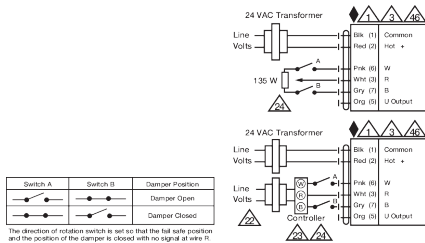

Typical and Override Control

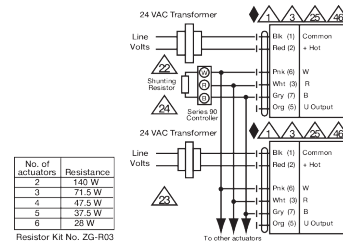

Multiple Actuators

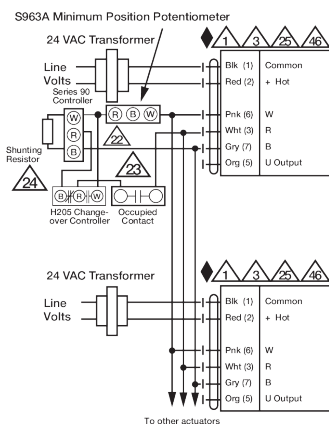

Multiple Actuators with Minimum Position Potentiometer

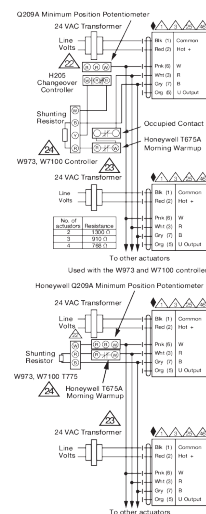

Multiple Actuators Used with W973, W7100 and T775