



5-year warranty

Technical data

| | | |
|---------------------------|---------------------------|---|
| Functional data | Valve Size | 4" [100] |
| | Fluid | chilled or hot water, up to 60% glycol |
| | Fluid Temp Range (water) | 32...350°F [0...176°C] |
| | Body Pressure Rating | ANSI Class 250, up to 280 psi below 350°F |
| | Flow characteristic | linear |
| | Servicing | repack/rebuild kits available |
| | Rangeability Sv | 50:1 |
| | Flow Pattern | 3-way Mixing |
| | Leakage rate | ANSI Class III |
| | Controllable flow range | stem up - open B – AB |
| | Cv | 190 |
| | ANSI Class | 250 |
| | Body pressure rating note | up to 280 psi below 350°F |
| Materials | Valve body | Cast iron - ASTM A126 Class B |
| | Valve plug | Stainless steel |
| | Stem seal | NLP EPDM (no lip packing) |
| | Seat | Stainless steel AISI 316 |
| | Pipe connection | 250 lb flanged |
| Suitable actuators | Non-Spring | EVB(X) RVB(X) |
| | Electronic fail-safe | (2*GKB(X)) |

Safety notes

- **WARNING:** This product can expose you to lead which is known to the State of California to cause cancer and reproductive harm. For more information go to www.p65warnings.ca.gov
- The valve has been designed for use in stationary heating, ventilation and air-conditioning systems and must not be used outside the specified field of application, especially in aircraft or in any other airborne means of transport.
- Only authorised specialists may carry out installation. All applicable legal or institutional installation regulations must be complied during installation.
- The valve does not contain any parts that can be replaced or repaired by the user.
- When determining the flow rate characteristic of controlled devices, the recognised directives must be observed.

Product features

Flow/Mounting details

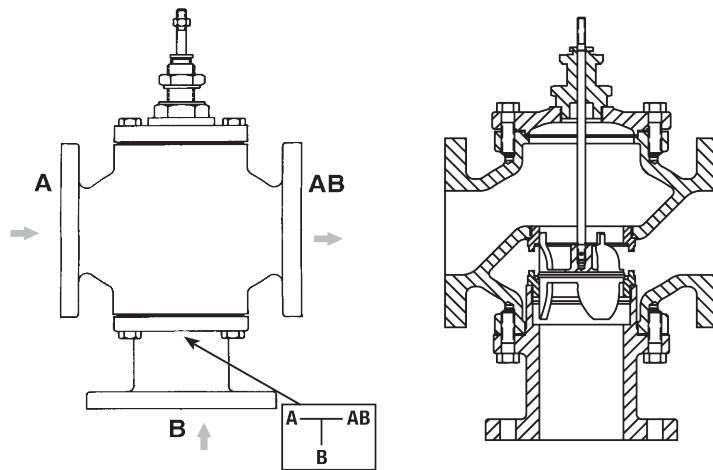

Dimensions

Dimensional drawings

EVB, EVX, RVB, RVX

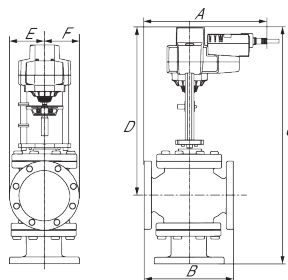

| A | B | C | D | E | F | Number of Bolt Holes |
|-------------|-------------|-------------|-------------|------------|------------|----------------------|
| 14.0" [356] | 13.6" [346] | 29.3" [743] | 19.0" [483] | 5.0" [127] | 5.0" [127] | 8 |

2*GMB, 2*GMX, 2*GKB, 2*GKX

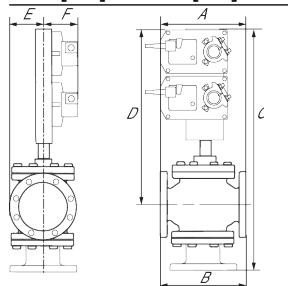

| A | B | C | D | E | F | Number of Bolt Holes |
|-------------|-------------|-------------|-------------|------------|------------|----------------------|
| 14.0" [356] | 13.6" [346] | 33.2" [844] | 23.4" [594] | 5.0" [127] | 5.0" [127] | 8 |

2*AFB, 2*AFX

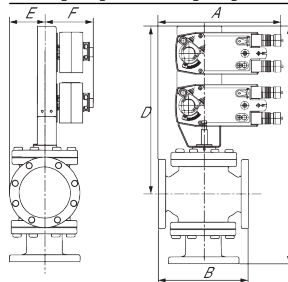

| A | B | C | D | E | F | Number of Bolt Holes |
|-------------|-------------|-------------|-------------|------------|------------|----------------------|
| 14.0" [356] | 13.6" [346] | 33.7" [857] | 23.4" [594] | 5.0" [127] | 5.3" [135] | 8 |



5-year warranty



Technical data

| | | |
|------------------------|------------------------------------|---|
| Electrical data | Nominal voltage | AC/DC 24 V |
| | Nominal voltage frequency | 50/60 Hz |
| | Power consumption in operation | 6 W |
| | Power consumption in rest position | 1.5 W |
| | Transformer sizing | 11 VA (class 2 power source) |
| | Electrical Connection | 18 GA plenum cable, 3 ft [1 m], with 1/2" conduit connector, degree of protection NEMA 2 / IP54 |
| | Overload Protection | electronic throughout full stroke |
| | Electrical Protection | actuators are double insulated |
| Functional data | Actuating force motor | 1010 lbf [4500 N] |
| | Operating range Y | 2...10 V |
| | Operating range Y note | 4...20 mA w/ ZG-R01 (500 Ω, 1/4 W resistor) |
| | Input Impedance | 100 kΩ for 2...10 V (0.1 mA), 500 Ω for 4...20 mA, 1500 Ω for On/Off |
| | Operating range Y variable | Start point 0.5...30 V End point 2.5...32 V |
| | Options positioning signal | variable (VDC, on/off, floating point) |
| | Position feedback U | 2...10 V |
| | Direction of motion motor | selectable with switch |
| | Manual override | 5 mm hex crank (3/16" Allen), supplied |
| | Stroke | 2" [50 mm] |
| | Running Time (Motor) | 90 s, constant, independent of load |
| | Running time motor note | constant, independent of load |
| | Noise level, motor | 65 dB(A) |
| Position indication | Mechanically, with pointer | |
| Safety data | Degree of protection IEC/EN | IP54 |
| | Degree of protection NEMA/UL | NEMA 2 UL Enclosure Type 2 |
| | Agency Listing | cULus acc. to UL60730-1A/-2-14, CAN/CSA E60730-1:02, CE acc. to 2014/30/EU and 2014/35/EU |
| | Quality Standard | ISO 9001 |
| | Ambient temperature | -22...122°F [-30...50°C] |
| | Storage temperature | -40...176°F [-40...80°C] |
| | Ambient humidity | max. 95% r.H., non-condensing |
| | Servicing | maintenance-free |
| Weight | Weight | 9.02 lb [4.1 kg] |
| Materials | Housing material | Die cast aluminium and plastic casing |

Safety notes



- PVC W/Shld for GV w/UGLK (GM)
- Battery Back Up System for SY(7~10)-110
- 120 to 24 VAC, 40 VA transformer.
- 50% voltage divider kit (resistors with wires).
- PC Tool computer programming interface, serial port.

Accessories

| Gateways | Description | Type |
|---------------|---|---------|
| | Gateway MP to BACnet MS/TP | UK24BAC |
| | Gateway MP to LonWorks | UK24LON |
| | Gateway MP to Modbus RTU | UK24MOD |
| Service tools | Description | Type |
| | Connection cable 10 ft [3 m], A: RJ11 6/4 ZTH EU, B: 3-pin Weidmüller and supply connection | ZK4-GEN |
| | Service Tool, with ZIP-USB function, for parametrisable and communicative Belimo actuators, VAV controller and HVAC performance devices | ZTH US |

Electrical installation

INSTALLATION NOTES

- 2 Actuators may be connected in parallel. Power consumption and input impedance must be observed.
- 3 Actuators may also be powered by 24 VDC.
- 7 A 500 Ω resistor (ZG-R01) converts the 4...20 mA control signal to 2...10 V.
- 8 Control signal may be pulsed from either the Hot (Source) or Common (Sink) 24 V line.
- 9 For triac sink the common connection from the actuator must be connected to the hot connection of the controller. Contact closures A & B also can be triacs. A & B should both be closed for the triac source and open for triac sink.
- 18 Actuators with plenum cable do not have numbers; use color codes instead.
- ◆ Meets cULus requirements without the need of an electrical ground connection.
- ! **Warning! Live Electrical Components!**
During installation, testing, servicing and troubleshooting of this product, it may be necessary to work with live electrical components. Have a qualified licensed electrician or other individual who has been properly trained in handling live electrical components perform these tasks. Failure to follow all electrical safety precautions when exposed to live electrical components could result in death or serious injury.

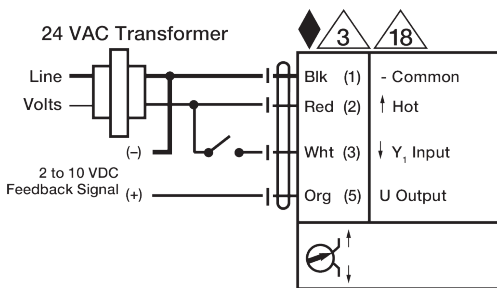

On/Off

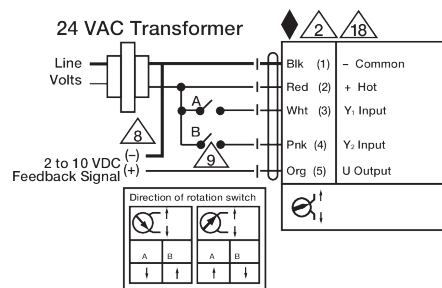

Floating Point

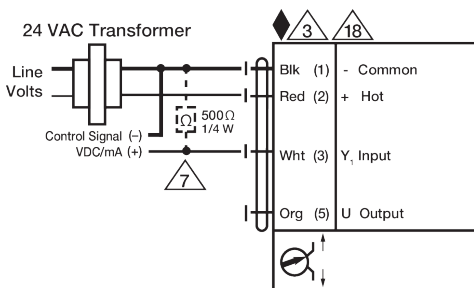

VDC / 4 to 20 mA

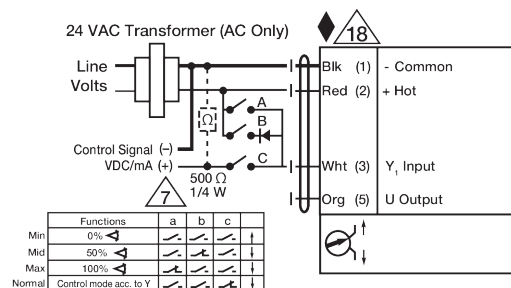

Override Control Min, Mid, Max Positions