



5-year warranty

Technical data

Functional data	Valve Size	3" [80]
	Fluid	chilled or hot water, up to 60% glycol
	Fluid Temp Range (water)	-20...350°F [-30...176°C]
	Body Pressure Rating	ANSI Class 125, up to 175 psi below 150°F
	Flow characteristic	linear
	Servicing	repack/rebuild kits available
	Rangeability Sv	50:1
	Flow Pattern	3-way Mixing
	Leakage rate	ANSI Class III
	Controllable flow range	stem up - open B – AB
	Cv	85
	ANSI Class	125
	Body pressure rating note	up to 175 psi below 150°F
Materials	Valve body	Cast iron - ASTM A126 Class B
	Valve plug	Stainless steel
	Stem seal	NLP EPDM (no lip packing)
	Seat	Stainless steel AISI 316
	Pipe connection	125 lb flanged
Suitable actuators	Non-Spring	EVB(X) RVB(X)
	Electronic fail-safe	AVKB(X) (2*GKB(X))

Safety notes

- **WARNING:** This product can expose you to lead which is known to the State of California to cause cancer and reproductive harm. For more information go to www.p65warnings.ca.gov
- The valve has been designed for use in stationary heating, ventilation and air-conditioning systems and must not be used outside the specified field of application, especially in aircraft or in any other airborne means of transport.
- Only authorised specialists may carry out installation. All applicable legal or institutional installation regulations must be complied during installation.
- The valve does not contain any parts that can be replaced or repaired by the user.
- When determining the flow rate characteristic of controlled devices, the recognised directives must be observed.

Product features

Flow/Mounting details

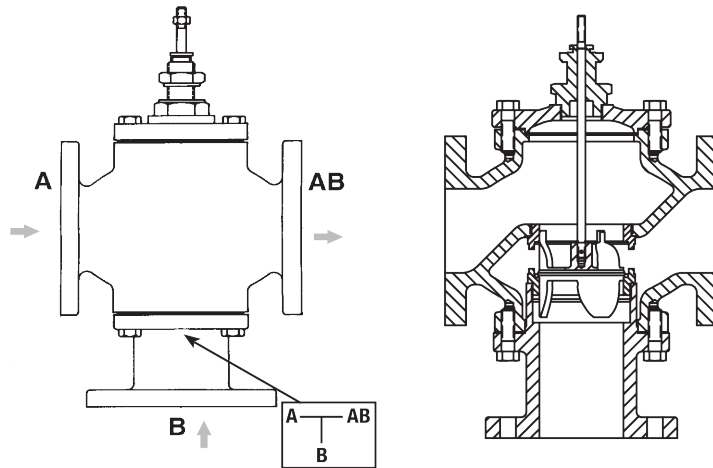

Dimensions

Dimensional drawings

EVB, EVX, RVB, RVX

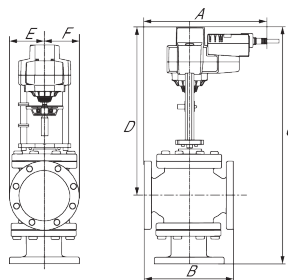

A	B	C	D	E	F	Number of Bolt Holes
12.2" [310]	10.0" [254]	27.0" [686]	19.0" [483]	3.9" [100]	3.9" [100]	4

2*GMB, 2*GMX, 2*GKB, 2*GKX

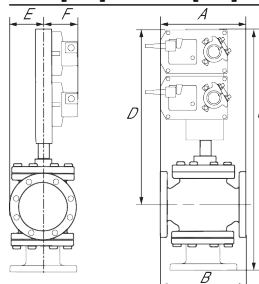

A	B	C	D	E	F	Number of Bolt Holes
12.2" [310]	10.0" [254]	30.5" [775]	22.5" [572]	3.7" [95]	5.3" [135]	4

AVKB, AVKX

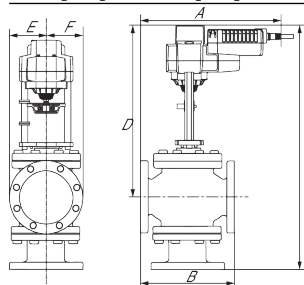

A	B	C	D	E	F	Number of Bolt Holes
13.1" [332]	10.0" [254]	27.0" [686]	19.0" [483]	3.9" [100]	3.9" [100]	4

AFB, AFX

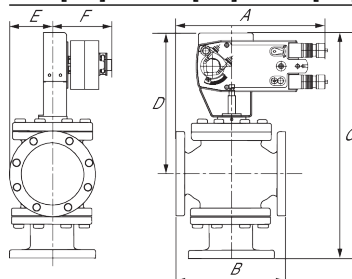

A	B	C	D	E	F	Number of Bolt Holes
12.2" [310]	10.0" [254]	25.6" [650]	17.5" [445]	3.7" [95]	5.3" [135]	4

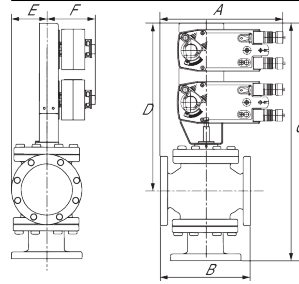

2*AFB, 2*AFX

A	B	C	D	E	F	Number of Bolt Holes
12.2" [310]	10.0" [254]	30.5" [775]	22.5" [572]	3.7" [95]	5.3" [135]	4



5-year warranty



Technical data

Electrical data	Nominal voltage	AC 24...240 V / DC 24...125 V
	Nominal voltage frequency	50/60 Hz
	Power consumption in operation	7 W
	Power consumption in rest position	3.5 W
	Transformer sizing	14 VA @ AC 24 V (class 2 power source), 17 VA @ AC 120 V, 36 VA @ AC 240 V
	Electrical Connection	18 GA appliance cable, 3 ft [1 m], with 1/2" conduit connector
	Overload Protection	electronic throughout 0...90° rotation
Functional data	Direction of motion motor	selectable by ccw/cw mounting
	Direction of motion fail-safe	reversible with cw/ccw mounting
	Manual override	5 mm hex crank (3/16" Allen), supplied
	Angle of rotation	95°
	Running Time (Motor)	75 s
	Running time fail-safe	<20 s
	Noise level, motor	50 dB(A)
	Noise level, fail-safe	62 dB(A)
Position indication	Mechanically, 30...65 mm stroke	
Safety data	Degree of protection IEC/EN	IP54
	Degree of protection NEMA/UL	NEMA 2 UL Enclosure Type 2
	Agency Listing	cULus acc. to UL60730-1A/-2-14, CAN/CSA E60730-1:02, CE acc. to 2014/30/EU
	Quality Standard	ISO 9001
	Ambient temperature	-22...122°F [-30...50°C]
	Storage temperature	-40...176°F [-40...80°C]
	Ambient humidity	max. 95% r.H., non-condensing
	Servicing	maintenance-free
Weight	Weight	9.03 lb [4.1 kg]
Materials	Housing material	Galvanized steel and plastic housing

Electrical installation

 **Warning! Live Electrical Components!**

During installation, testing, servicing and troubleshooting of this product, it may be necessary to work with live electrical components. Have a qualified licensed electrician or other individual who has been properly trained in handling live electrical components perform these tasks. Failure to follow all electrical safety precautions when exposed to live electrical components could result in death or serious injury.

 Actuators with appliance cables are numbered.

 Universal Power Supply (UP) models can be supplied with 24 VAC up to 240 VAC, or 24 VDC up to 125 VDC.

- Apply only AC line voltage or only UL-Class 2 voltage to the terminals of auxiliary switches. Mixed or combined operation of line voltage/safety extra low voltage is not allowed.
- Meets cULus requirements without the need of an electrical ground connection.
- Provide overload protection and disconnect as required.
- Actuators may also be powered by 24 VDC.
- Actuators may be powered in parallel. Power consumption must be observed.
- Parallel wiring required for piggy-back applications.

