



5-year warranty

**Technical data**

<b>Functional data</b>	Valve Size	3" [80]
	Fluid	chilled or hot water, up to 60% glycol
	Fluid Temp Range (water)	-20...350°F [-30...176°C]
	Body Pressure Rating	ANSI Class 125, up to 175 psi below 150°F
	Flow characteristic	linear
	Servicing	repack/rebuild kits available
	Rangeability Sv	50:1
	Flow Pattern	3-way Mixing
	Leakage rate	ANSI Class III
	Controllable flow range	stem up - open B – AB
	Cv	85
	ANSI Class	125
	Body pressure rating note	up to 175 psi below 150°F
<b>Materials</b>	Valve body	Cast iron - ASTM A126 Class B
	Valve plug	Stainless steel
	Stem seal	NLP EPDM (no lip packing)
	Seat	Stainless steel AISI 316
	Pipe connection	125 lb flanged
<b>Suitable actuators</b>	Non-Spring	EVB(X) RVB(X)
	Electronic fail-safe	AVKB(X) (2*GKB(X))

**Safety notes**

- **WARNING:** This product can expose you to lead which is known to the State of California to cause cancer and reproductive harm. For more information go to [www.p65warnings.ca.gov](http://www.p65warnings.ca.gov)
- The valve has been designed for use in stationary heating, ventilation and air-conditioning systems and must not be used outside the specified field of application, especially in aircraft or in any other airborne means of transport.
- Only authorised specialists may carry out installation. All applicable legal or institutional installation regulations must be complied during installation.
- The valve does not contain any parts that can be replaced or repaired by the user.
- When determining the flow rate characteristic of controlled devices, the recognised directives must be observed.

**Product features**

Flow/Mounting details

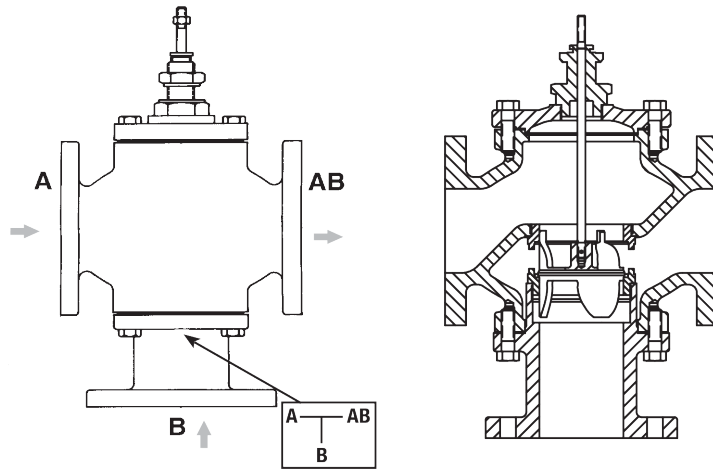

Dimensions

Dimensional drawings

EVB, EVX, RVB, RVX



A	B	C	D	E	F	Number of Bolt Holes
12.2" [310]	10.0" [254]	27.0" [686]	19.0" [483]	3.9" [100]	3.9" [100]	4

2\*GMB, 2\*GMX, 2\*GKB, 2\*GKX

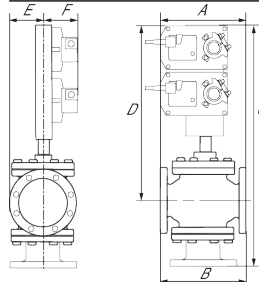

A	B	C	D	E	F	Number of Bolt Holes
12.2" [310]	10.0" [254]	30.5" [775]	22.5" [572]	3.7" [95]	5.3" [135]	4

AVKB, AVKX

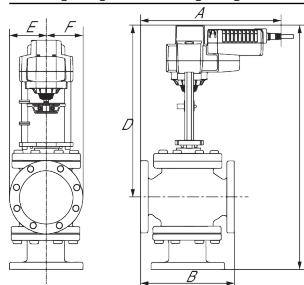

A	B	C	D	E	F	Number of Bolt Holes
13.1" [332]	10.0" [254]	27.0" [686]	19.0" [483]	3.9" [100]	3.9" [100]	4

AFB, AFX

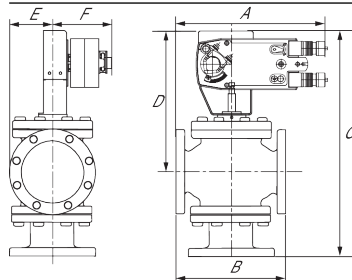

A	B	C	D	E	F	Number of Bolt Holes
12.2" [310]	10.0" [254]	25.6" [650]	17.5" [445]	3.7" [95]	5.3" [135]	4

2\*AFB, 2\*AFX

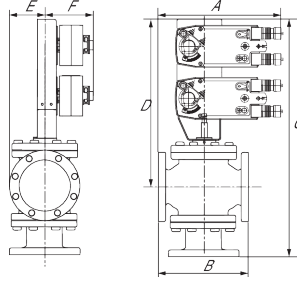

A	B	C	D	E	F	Number of Bolt Holes
12.2" [310]	10.0" [254]	30.5" [775]	22.5" [572]	3.7" [95]	5.3" [135]	4



5-year warranty



Technical data

<b>Electrical data</b>	Nominal voltage	AC/DC 24 V
	Nominal voltage frequency	50/60 Hz
	Power consumption in operation	7.5 W
	Power consumption in rest position	3 W
	Transformer sizing	20 VA (class 2 power source)
	Electrical Connection	18 GA appliance cable, 3ft [1m] 10ft [3m] and 16ft [5m], with 1/2" conduit connector, degree of protection NEMA 2 / IP54
	Overload Protection	electronic throughout 0...95° rotation
<b>Functional data</b>	Operating range Y	2...10 V
	Operating range Y note	4...20 mA w/ ZG-R01 (500 Ω, 1/4 W resistor)
	Input Impedance	100 kΩ for 2...10 V (0.1 mA), 500 Ω for 4...20 mA, 1500 Ω for PWM, On/Off and Floating point
	Operating range Y variable	Start point 0.5...30 V End point 2.5...32 V
	Options positioning signal	variable (VDC, PWM, on/off, floating point)
	Position feedback U	2...10 V
	Position feedback U note	Max. 0.5 mA
	Position feedback U variable	VDC variable
	Direction of motion motor	selectable with switch 0/1
	Direction of motion fail-safe	reversible with cw/ccw mounting
	Manual override	5 mm hex crank (3/16" Allen), supplied
	Angle of rotation	95°, adjustable with mechanical end stop, 35...95°
	Angle of rotation note	adjustable with mechanical end stop, 35...95°
	Running Time (Motor)	default 150 s, variable 70...220 s
	Running time motor variable	70...220 s
	Running time fail-safe	<20 s
	Override control	MIN (minimum position) = 0% MID (intermediate position) = 50% MAX (maximum position) = 100%
	Noise level, motor	40 dB(A)
	Noise level, fail-safe	62 dB(A)
	Position indication	Mechanical
<b>Safety data</b>	Degree of protection IEC/EN	IP54
	Degree of protection NEMA/UL	NEMA 2 UL Enclosure Type 2
	Agency Listing	cULus acc. to UL60730-1A/-2-14, CAN/CSA E60730-1:02, CE acc. to 2014/30/EU
	Quality Standard	ISO 9001
	Ambient temperature	-22...122°F [-30...50°C]
	Storage temperature	-40...176°F [-40...80°C]

Ambient humidity	max. 95% r.H., non-condensing
Servicing	maintenance-free
<b>Weight</b>	Weight 9.26 lb [4.2 kg]
<b>Materials</b>	Housing material Galvanized steel and plastic housing

**Safety notes**

- NEMA 4X, 316L stainless steel enclosure.
- Battery Back Up System for SY(7-10)-110
- ZS-300 without brackets.
- NEMA 4X, 304 stainless steel enclosure.
- MFT95 resistor kit for 4 to 20 mA control applications.

**Accessories**

Gateways	Description	Type
	Gateway MP to BACnet MS/TP	UK24BAC
	Gateway MP to LonWorks	UK24LON
	Gateway MP to Modbus RTU	UK24MOD
Service tools	Description	Type
	Connection cable 10 ft [3 m], A: RJ11 6/4 ZTH EU, B: 3-pin Weidmüller and supply connection	ZK4-GEN
	Service Tool, with ZIP-USB function, for parametrisable and communicative Belimo actuators, VAV controller and HVAC performance devices	ZTH US

**Electrical installation**
**Warning! Live Electrical Components!**

During installation, testing, servicing and troubleshooting of this product, it may be necessary to work with live electrical components. Have a qualified licensed electrician or other individual who has been properly trained in handling live electrical components perform these tasks. Failure to follow all electrical safety precautions when exposed to live electrical components could result in death or serious injury.

**(A)** Actuators with appliance cables are numbered.

◆ Meets cULus requirements without the need of an electrical ground connection.

**1** Provide overload protection and disconnect as required.

**3** Actuators may also be powered by 24 VDC.

**5** Only connect common to negative (-) leg of control circuits.

**7** A 500 Ω resistor (ZG-R01) converts the 4...20 mA control signal to 2...10 V.

**8** Control signal may be pulsed from either the Hot (Source) or Common (Sink) 24 V line.

**10** For triac sink the Common connection from the actuator must be connected to the Hot connection of the controller. Position feedback cannot be used with a triac sink controller; the actuator internal common reference is not compatible.

**12** IN4004 or IN4007 diode. (IN4007 supplied, Belimo part number 40155).

**46** Actuators may be controlled in parallel. Current draw and input impedance must be observed.

**47** Master-Slave wiring required for piggy-back applications. Feedback from Master to control input(s) of Slave(s).

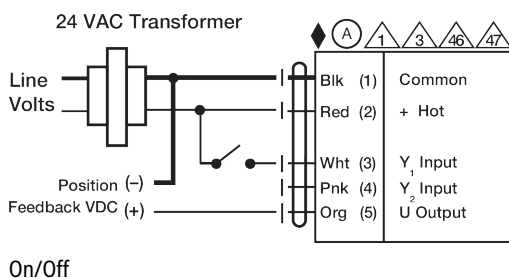
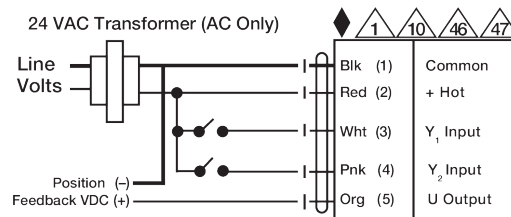

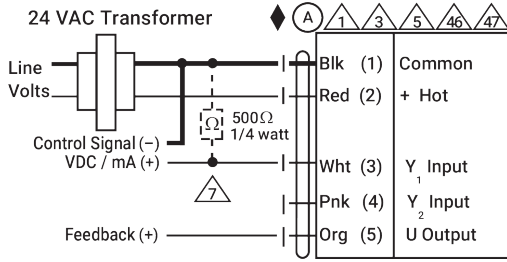
**On/Off**

**Floating Point**

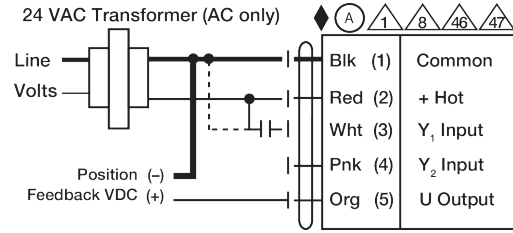

VDC/mA Control

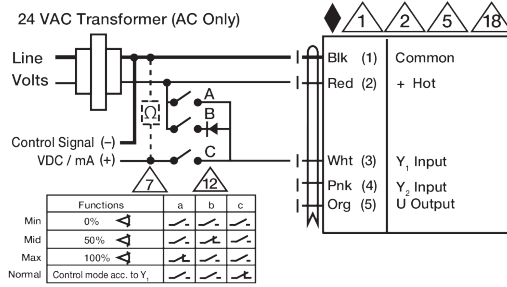

PWM Control



Override Control

Functions	a	b	c
Min	0%	<input type="checkbox"/>	<input type="checkbox"/>
Mid	50%	<input type="checkbox"/>	<input type="checkbox"/>
Max	100%	<input type="checkbox"/>	<input type="checkbox"/>
Normal	Control mode acc. to Y <sub>1</sub>		

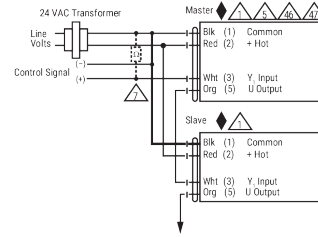

Master - Slave