



5-year warranty

Technical data

Functional data	Mounting Position	90° to 180°
	<hr/>	
Safety data	Ambient temperature	-22...122°F [-30...50°C]
	Storage temperature	-40...176°F [-40...80°C]
Materials	Housing material	galvanized steel
	Stem	steel
	Frame, plate, base	galvanized steel
	Bearing	GF Delrin
Suitable actuators	Non-Spring	AMB(X) GMB(X) NMB(X)
	Electronic fail-safe	NKQB(X)

* ZG-121 adapter must be used with EF. ** GM/GK not for use with 1/2" shafts. *** K6-1 clamp must be used with LF. For close-off pressure reference Select Pro or Retrofit Technical Documentation.
For close-off pressure reference Select Pro or retrofit technical documentation.

Product features

- Default/Configuration** The ZG-JSL linkage can also be configured by moving the anti-rotation plate 90° for space-saving applications. See mounting configurations below. The ZG-JSLA will have a factory mounted actuator on the linkage in the vertical position only.
- Application** The ZG-JSL jackshaft linkage is designed to easily attach to any part of a jackshaft and allow easy installation of select Belimo actuators. The unique open ended design and clamp insert allows the ZG-JSL to be used with any jackshaft from 1/2" to 3/4" in diameter. Removal of the insert will allow the linkage to attach to a maximum shaft diameter of 1.05". Changing the antirotation plate will allow various actuators to be mounted.
- Operation** The 3/4" diameter built-in steel shaft allows direct coupling to the Belimo series actuators in the chart below. There is a torque reduction when using the ZG-JSL linkage. Verify application requirements before use.

Flow/Mounting details



Dimensions

Dimensional drawings

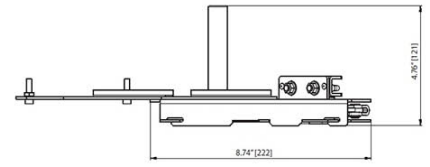
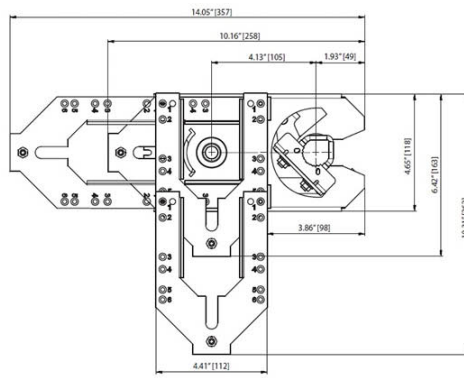



5-year warranty



MFT

Technical data

Electrical data	Nominal voltage	AC/DC 24 V
	Nominal voltage frequency	50/60 Hz
	Power consumption in operation	3.5 W
	Power consumption in rest position	1.3 W
	Transformer sizing	6 VA (class 2 power source)
	Electrical Connection	18 GA plenum cable with 1/2" conduit connector, degree of protection NEMA 2 / IP54, 3 ft [1 m] 10 ft [3 m] and 16ft [5 m]
	Overload Protection	electronic throughout 0...95° rotation
Functional data	Torque motor	90 in-lb [10 Nm]
	Operating range Y	2...10 V
	Operating range Y note	4...20 mA w/ ZG-R01 (500 Ω, 1/4 W resistor)
	Input Impedance	100 kΩ for 2...10 V (0.1 mA), 500 Ω for 4...20 mA, 1500 Ω for PWM, On/Off and Floating point
	Operating range Y variable	Start point 0.5...30 V End point 2.5...32 V
	Options positioning signal	variable (VDC, PWM, on/off, floating point)
	Position feedback U	2...10 V
	Position feedback U note	Max. 0.5 mA
	Position feedback U variable	VDC variable
	Direction of motion motor	selectable with switch 0/1
	Manual override	external push button
	Angle of rotation	Max. 95°, adjustable with mechanical stop
	Angle of rotation note	adjustable with mechanical stop
	Running Time (Motor)	default 150 s, variable 45...170 s
	Running time motor variable	45...170 s
	Noise level, motor	45 dB(A)
	Shaft Diameter	1/2...1.05" round, centers on 1/2" and 3/4" with insert, 1.05" without insert
Position indication	Mechanically, 30...65 mm stroke	
Safety data	Degree of protection IEC/EN	IP54
	Degree of protection NEMA/UL	NEMA 2 UL Enclosure Type 2
	Agency Listing	cULus acc. to UL60730-1A/-2-14, CAN/CSA E60730-1:02, CE acc. to 2014/30/EU and 2014/35/EU
	Quality Standard	ISO 9001
	Ambient temperature	-22...122°F [-30...50°C]
	Storage temperature	-40...176°F [-40...80°C]
	Ambient humidity	max. 95% r.H., non-condensing
	Servicing	maintenance-free

Weight	Weight	1.2 lb [0.54 kg]
Materials	Housing material	UL94-5VA

Product features

Application	<p>For proportional modulation of dampers in HVAC systems. Actuator sizing should be done in accordance with the damper manufacturer's specifications.</p> <p>The actuator is mounted directly to a damper shaft up to 1.05" in diameter by means of its universal clamp. A crank arm and several mounting brackets are available for applications where the actuator cannot be direct coupled to the damper shaft.</p> <p>The default parameters for 2 to 10 VDC applications of the ...MFT actuator are assigned during manufacturing. If necessary, custom versions of the actuators can be ordered. The parameters can be changed by two means: pre-set and custom configurations from Belimo or on-site configurations using the Belimo PC-Tool software.</p>
Operation	<p>The actuator is not provided with and does not require any limit switches, but is electronically protected against overload. The anti-rotation strap supplied with the actuator will prevent lateral movement.</p> <p>The NMB(X) series provides 95° of rotation and a visual indicator indicates position of the actuator. When reaching the damper or actuator end position, the actuator automatically stops. The gears can be manually disengaged with a button on the actuator cover.</p> <p>The NMB(X)24-MFT actuators use a brushless DC motor, which is controlled by an Application Specific Integrated Circuit (ASIC). The ASIC monitors and controls the actuator's rotation and provides a digital rotation sensing (DRS) function to prevent damage to the actuator in a stall condition. Power consumption is reduced in holding mode.</p> <p>Add-on auxiliary switches or feedback potentiometers are easily fastened directly onto the actuator body for signaling and switching functions.</p>
Typical specification	<p>Proportional control damper actuators shall be electronic direct-coupled type, which require no crank arm and linkage and be capable of direct mounting to a shaft from 1/4" to 1/2" diameter. Actuators must provide proportional damper control response to a 2 to 10 VDC or, with the addition of a 500Ω resistor, a 4 to 20 mA control input from an electronic controller or positioner. Actuators shall have brushless DC motor technology and be protected from overload at all angles of rotation. Actuators shall have manual override on the cover. Run time shall be constant and independent of torque. Actuators shall be cULus listed, have a 5-year warranty, and be manufactured under ISO 9001 International Quality Control Standards. Actuators shall be as manufactured by Belimo.</p>

Accessories

Gateways	Description	Type
	Gateway MP to BACnet MS/TP	UK24BAC
	Gateway MP to LonWorks	UK24LON
	Gateway MP to Modbus RTU	UK24MOD
Electrical accessories	Description	Type
	Battery backup system, for non-spring return models	NSV24 US
	Feedback potentiometer 10 kΩ add-on, grey	P10000A GR
	Feedback potentiometer 1 kΩ add-on, grey	P1000A GR
	Feedback potentiometer 140 Ω add-on, grey	P140A GR
	Feedback potentiometer 2.8 kΩ add-on, grey	P2800A GR
	Feedback potentiometer 5 kΩ add-on, grey	P5000A GR
	Feedback potentiometer 500 Ω add-on, grey	P500A GR
	Auxiliary switch 1 x SPDT add-on	S1A
	Auxiliary switch 2 x SPDT add-on	S2A
	Positioner for wall mounting	SGA24
	Resistor, 500 Ω, 1/4" wire resistor with 6" pigtail wires	ZG-R01
	Transformer, AC 120 V to AC 24 V, 40 VA	ZG-X40
Mechanical accessories	Description	Type
	Shaft extension 240 mm Ø20 mm for damper shaft Ø 8...22.7 mm	AV8-25
	Shaft clamp reversible, clamping range Ø8...20 mm	K-NA
	Wrench 8 mm and 10 mm	TOOL-06

17" Mounting Bracket for AF,NF,GM,AM,SM	ZG-100
Mounting Bracket: AF,NF,LF,GM,AM,NM,SM	ZG-101
Mounting Bracket: GM,AM,SM	ZG-103
Mounting Bracket: GM,AM,SM	ZG-104
Mounting kit for linkage operation for flat installation	ZG-NMA
Shaft extension for 1/2" diameter shafts (3.8" L).	ZG-NMSA-1
Weather shield 13x8x6" [330x203x152 mm] (LxWxH)	ZS-100
Weather shield 16x8-3/8x4" [406x213x102 mm] (LxWxH)	ZS-150

Service tools	Description	Type
	Connection cable 10 ft [3 m], A: RJ11 6/4 ZTH EU, B: 3-pin Weidmüller and supply connection	ZK4-GEN
	Service Tool, with ZIP-USB function, for parametrisable and communicative Belimo actuators, VAV controller and HVAC performance devices	ZTH US

Electrical installation

- Ⓐ Actuators with appliance cables are numbered.
- ⚠️ 1 Provide overload protection and disconnect as required.
- ⚠️ 3 Actuators may also be powered by 24 VDC.
- ⚠️ 5 Only connect common to negative (-) leg of control circuits.
- ⚠️ 7 A 500 Ω resistor (ZG-R01) converts the 4...20 mA control signal to 2...10 V.
- ⚠️ 8 Control signal may be pulsed from either the Hot (Source) or Common (Sink) 24 V line.
- ⚠️ 10 For triac sink the Common connection from the actuator must be connected to the Hot connection of the controller. Position feedback cannot be used with a triac sink controller; the actuator internal common reference is not compatible.
- ⚠️ 11 Actuators may be connected in parallel if not mechanically linked. Power consumption and input impedance must be observed.
- ⚠️ 12 IN4004 or IN4007 diode. (IN4007 supplied, Belimo part number 40155).

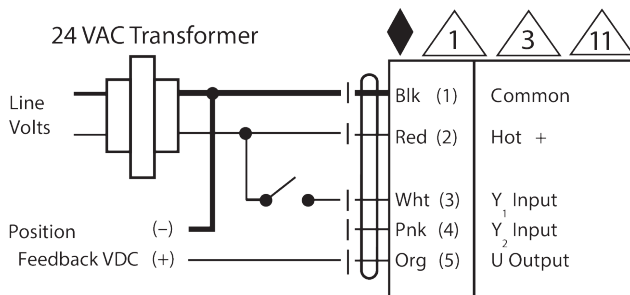
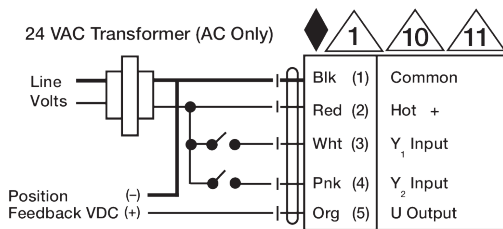
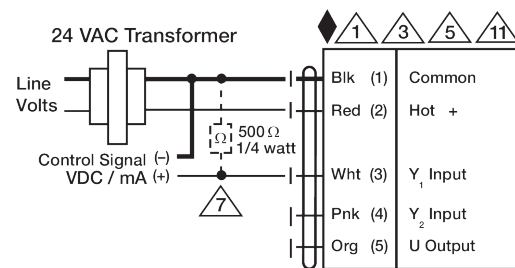
On/Off

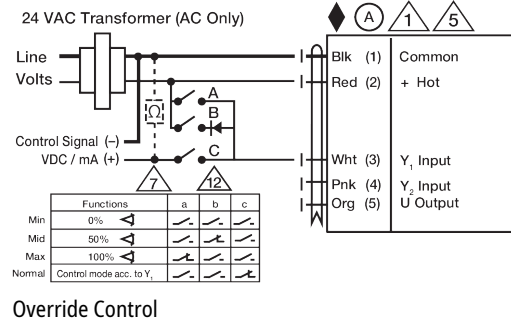
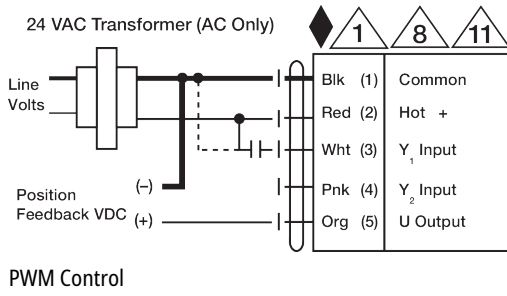
Floating Point

VDC/mA Control



Dimensions

Dimensional drawings \varnothing 1/2" to 1.05 [12.7 to 26.67]
 □ 2/5" to 1.05 [10 to 26.67]

