



2-year warranty



Technical data

Functional data	Valve Size	0.5" [15]
	Fluid	chilled or hot water, up to 50% glycol
	Fluid Temp Range (water)	32...212°F [0...100°C]
	Body Pressure Rating	300 psi
	Close-off pressure Δ ps	50 psi
	Flow characteristic	on/off, diverting
	Flow Pattern	3-way
	Leakage rate	ANSI Class III 0.1%
	Cv	2.5
	Body pressure rating note	300 psi
Materials	Valve body	forged brass
	Housing seal	EPDM
	Seat	EPDM
	Pipe connection	NPT female ends
Suitable actuators	Spring	ZONE

Product features

Application This valve is typically used on fan coil units, baseboards or other hydronic applications where fail safe operation on 2-wire control is required. This valve is suitable for use in a hydronic system with variable or constant flow.

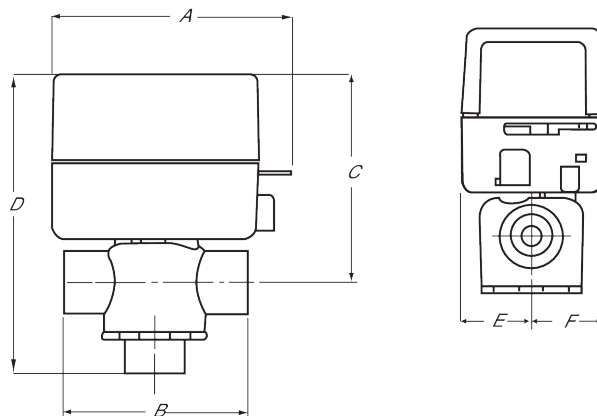
This valve is designed to fit in compact areas where on/off or control is required using 24 VAC or 120 VAC.

Dimensions
Dimensional drawings

A	B	C	D	E	F
4.0" [102]	2.8" [70]	3.5" [89]	4.8" [122]	1.2" [30]	1.2" [31]



2-year warranty

Technical data

Electrical data	Nominal voltage	AC 120 V
	Nominal voltage frequency	50/60 Hz
	Power consumption in operation	6.5 W
	Transformer sizing	7 VA (class 2 power source)
	Auxiliary switch	1 x SPST, 5 A resistive (5 A inductive) @ AC 120 V,
	Switching capacity auxiliary switch	5 A resistive (5 A inductive) @ AC 120 V
	Electrical Connection	6" wire leads
Functional data	Manual override	hand lever
	Angle of rotation	90°
	Angle of rotation note	90°
	Running time fail-safe	<5 s Variable: 2.5...10 s
	Noise level, motor	35 dB(A)
	Noise level, fail-safe	35 dB(A)
	Position indication	Mechanically (integrated)
Safety data	Degree of protection IEC/EN	IP20
	Degree of protection NEMA/UL	NEMA 1 UL Enclosure Type 1
	Agency Listing	CE, cULus
	Quality Standard	ISO 9001
	Ambient temperature	32...104°F [0...40°C]
	Storage temperature	-40...176°F [-40...80°C]
	Ambient humidity	max. 95% r.H., non-condensing
	Servicing	maintenance-free
Weight	Weight	0.88 lb [0.40 kg]

Electrical installation
INSTALLATION NOTES

- ◆ Meets cULus requirements without the need of an electrical ground connection.
- ⚠ One built-in auxiliary switch, 1x SPST 0.4A @ 24 VAC (resistive and inductive loads).

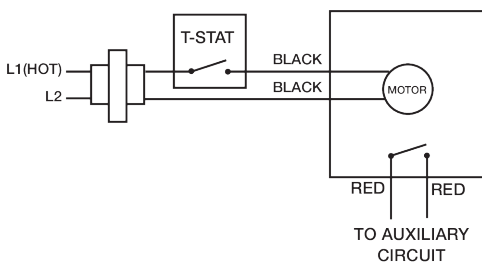

Built-in Auxiliary Switch (optional) (only on -S models)