

Bell & Gossett®
Parts List CP-206G-PL

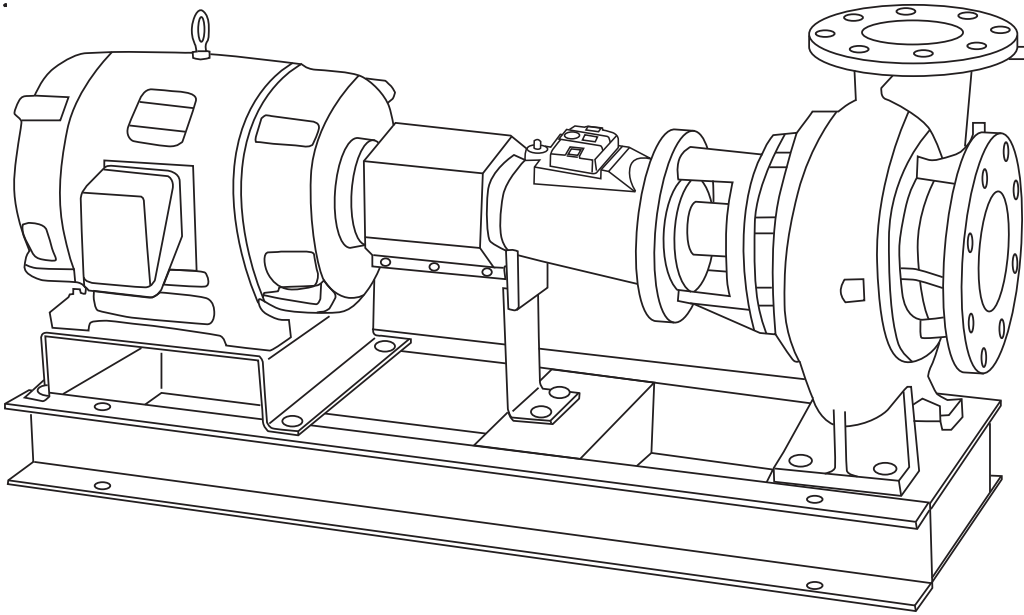

Replacement Parts for
Series 1510
Stuffing Box Type
Centrifugal Pumps

Engineered for life

SERIES 1510

Index

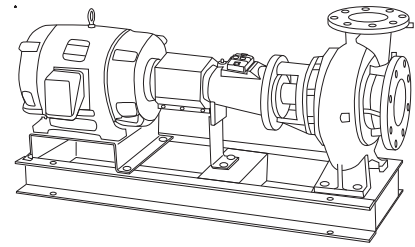

How To Use This Parts List	3
Series 1510 Stuffing Box Exploded View	4
Series 1510 Bearing Frame Assembly Exploded View.....	5
Series 1510 8G Stuffing Box Exploded View	6
Series 1510 Pump Bearing Frame Selection Chart.....	7
Size 1 ¹ / ₄ AB Pump Parts	8
Size 1 ¹ / ₄ AC Pump Parts	9
Size 1 ¹ / ₂ AB Pump Parts	10
Size 1 ¹ / ₂ AC Pump Parts	11
Size 2AB Pump Parts	12
Size 2AC Pump Parts	13
Size 2 ¹ / ₂ A Pump Parts.....	14
Size 2 ¹ / ₂ AB Pump Parts	15
Size 3AB Pump Parts	16
Size 3AC Pump Parts	17
Size 4AB Pump Parts	18
Size 4AC Pump Parts	19
Size 5A Pump Parts.....	20
Size 1 ¹ / ₄ BB Pump Parts	21
Size 1 ¹ / ₄ BC Pump Parts.....	22
Size 1 ¹ / ₂ BB & 1 ¹ / ₂ BC Pump Parts.....	23
Size 2BB Pump Parts	24
Size 2BC Pump Parts	25
Size 2 ¹ / ₂ B Pump Parts	26
Size 2 ¹ / ₂ BB Pump Parts	27
Size 3BB Pump Parts	28
Size 3BC Pump Parts.....	29
Size 4BB Pump Parts.....	30
Size 4BC Pump Parts	31
Size 5BB Pump Parts	32
Size 5BC Pump Parts.....	33
Size 6BB Pump Parts	34
Size 6BC Pump Parts.....	35
Size 2CB Pump Parts.....	36
Size 3CB Pump Parts	37
Size 4CB Pump Parts.....	38
Size 5CB Pump Parts.....	39
Size 6CB Pump Parts.....	40
Size 2E Pump Parts.....	41
Size 3E Pump Parts.....	42
Size 4E Pump Parts.....	43
Size 5E Pump Parts.....	44
Size 6E Pump Parts.....	45
Size 2G Pump Parts	46
Size 3G Pump Parts	47
Size 4G Pump Parts	48
Size 4GB Pump Parts.....	49
Size 5G Pump Parts	50
Size 6G Pump Parts	51
Size 8G Pump Parts	52
Series 1510 Coupler Selection Chart	53
ANSI/OSHA Guard & Bracket Kit Selection Chart	54
Mechanical Seals for 1510 Stuffing Box Type Pumps.....	55
Packing Sets for 1510 Stuffing Box Type Pumps	55

How to use this PARTS LIST

The pump nameplate identifies the pump by pipe size, seal configuration, pump construction and impeller diameter as shown below. Pumps manufactured in 2001 and before have a nameplate similar to the nameplate below left. Pumps manufactured in 2001 and after have a nameplate similar to the one below right. Although the nameplates look different, they each display the same information.

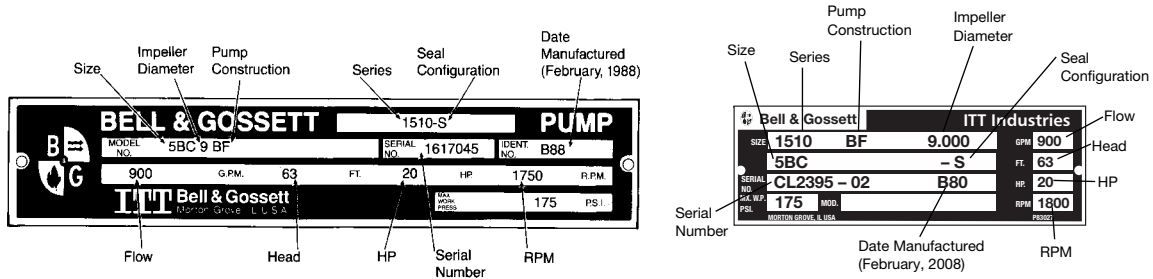

The nameplates above identify the pump as a Series 1510, size 5BC with a “-S” seal and bronze-fitted (BF) construction. The pump was furnished with a 9" impeller and a 20 horsepower, 1750 (1800) RPM motor. The serial number specifically identifies the pump for future reference. **DO NOT REMOVE THE NAMEPLATE.** It is important when ordering replacement parts to furnish complete nameplate data.

The Series 1510 pump is furnished in a “Standard Seal” or “Stuffing Box” construction. The “Stuffing Box” model has three positive seal configurations:

Series 1510-S Single Seal Series 1510-D Double Seal

Series 1510-PF Packing Rings with Flush (Lantern) Ring

The “Standard Seal” pump has no seal designation after the Series number on the nameplate. Parts for the “Standard Seal” pumps are covered in the CP-207H-PL parts list.

To ensure correct parts are chosen, use the following procedure:

1. Determine from the nameplate the pump size, pump construction, seal configuration, and impeller diameter.
2. Measure the shaft sleeve diameter at the seal.
3. Refer to the index for the page number of the parts breakdown for the specific size pump.
4. Find the proper column in the parts breakdown for the pump construction involved.
5. Select part numbers using the numbered drawings on pages 4,5 or 6 for identification. Where shaft diameter affects parts selection, use the measurement secured in Step 2.
6. Bearing frames vary with motor frame sizes. Use the motor frame number from the motor nameplate to select the proper bearing frame from the chart on page 7.

Ball Bearing Frame Assembly**

STUFFING BOX CONSTRUCTION

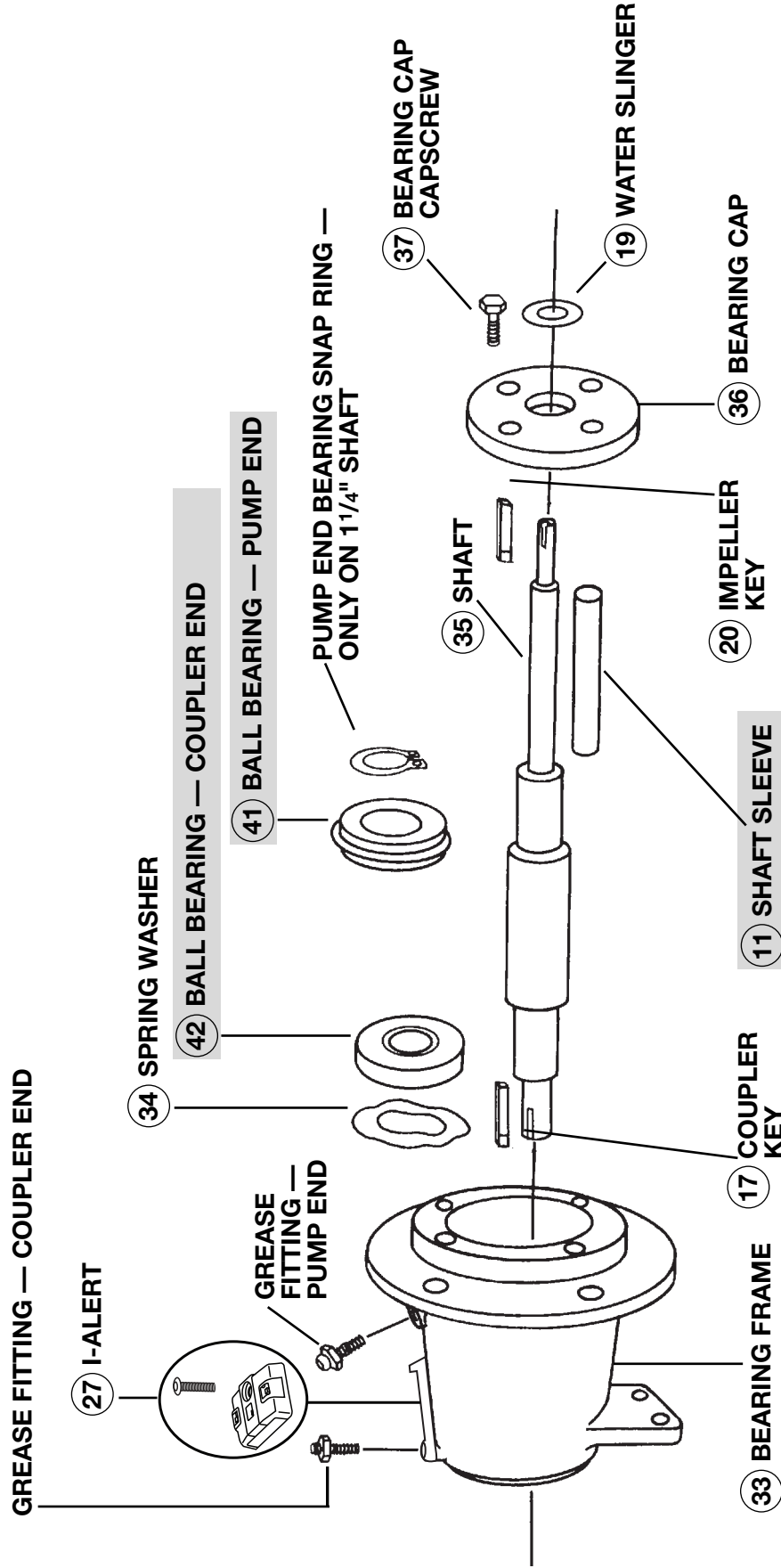

Note: Bearing lockwasher, bearing locknut and coupler end bearing cap (not shown) used on extra large bearing assembly only.

**See page 6 for exploded view of 8G Bearing Frame Assembly.

— Factory recommended spare parts

Series 1510 8G Pump STUFFING BOX CONSTRUCTION

Exploded View

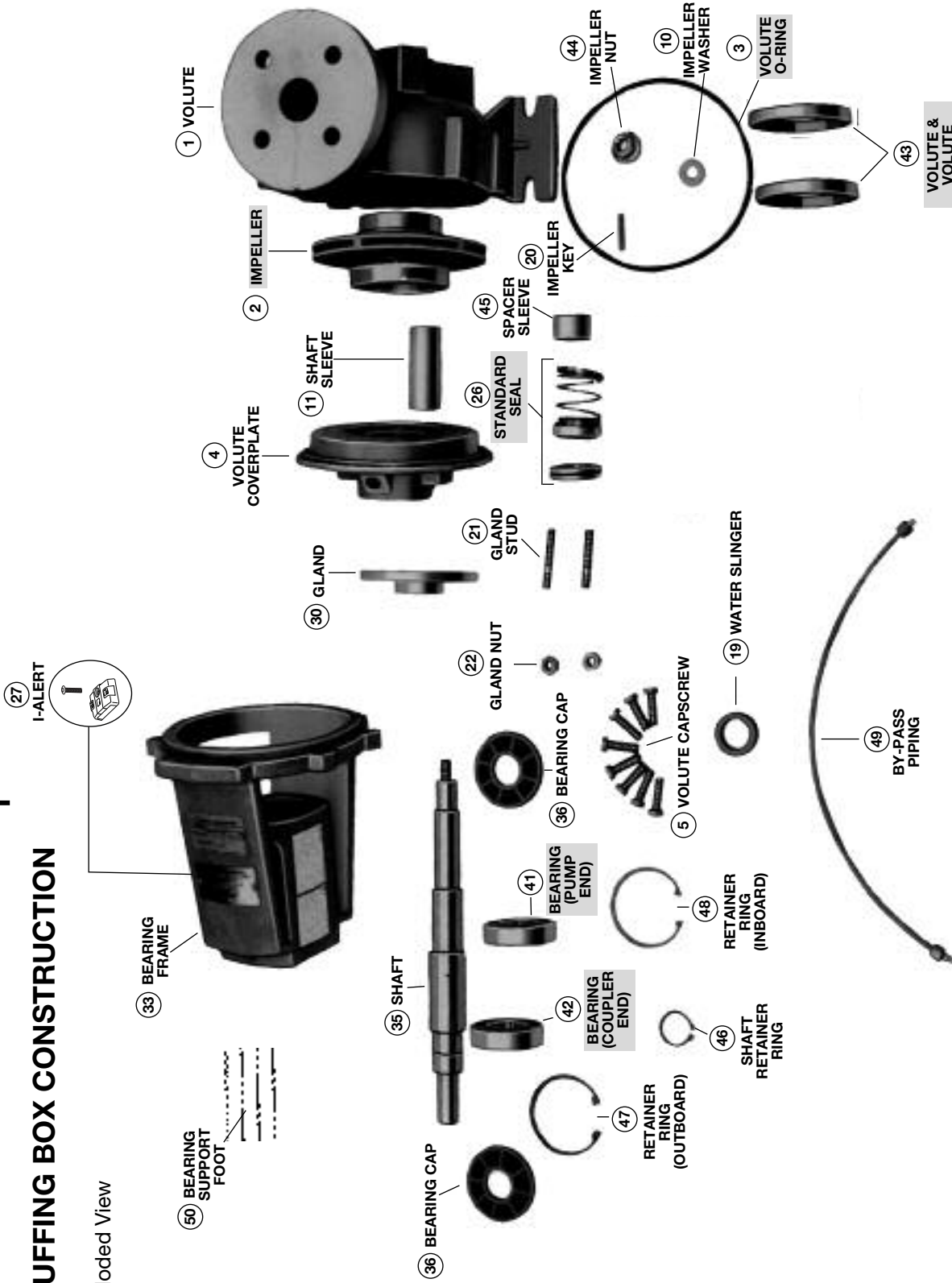

— Factory recommended spare parts

1 1/4AB

ITEM NO.	DESCRIPTION	PUMP CONSTRUCTION		
		BRONZE FITTED	BRONZE FITTED W/WEAR RING	ALL IRON
1	Volute	N/A**	N/A**	N/A**
	Wear Ring	—	P46700	—
	Volute Drain Plug (4)	P39020	P39020	P39030
5	Volute Capscrew (8)	P40020	P40020	P40020
3	Volute Gasket	P57700	P57700	P57700
17	Coupler Key (Straight) Aug. 1989 (H98) and After	P49379	P49379	P49379
17	Coupler Key (Woodruff) July 1989 (G98) and Before	H32600	H32600	H32600
	Seal or Packing	See Table A, B, C or D, Page 55		
16	Coupler	See Coupler Selection Table, Page 53		
ANSI/OSHA Coupling Guard & Support Bracket Kit Selection, See Page 54				
2	Impeller (State Diameter) 7" Full Dia.	P46630	P46630	N/A**
8	Impeller Capscrew	P52350	P52350	P52350
9	Impeller Lockwasher	J23874	J23874	J23874
10	Impeller Washer	P46380	P46380	P46381
20	Impeller Key (Woodruff) July 1989 (G98) and Before	H32500	H32500	H32500
4	Volute Coverplate	P85027	P85027	P85027
44	Bracket	P85023	P85023	P85023
18	Bearing Frame Assembly Consisting of:	185321	185321	185321
33	Bearing Frame	P85014	P85014	P85014
35	Shaft	P85017	P85017	P85017
36	Bearing Cap	P85020	P85020	P85020
41	Ball Bearing – Pump End	186002	186002	186002
42	Ball Bearing – Coupler End	186001	186001	186001
27	i-ALERT Condition Monitor	185400	185400	185400
34	Spring Washer	J92558	J92558	J92558
37	Bearing Cap Capscrew (4)	P32000	P32000	P32000
19	Water Slinger	P53550	P53550	P53550

N/A — NO LONGER AVAILABLE

**The impeller and/or volute are no longer available. This pump can be converted to the current style pump by ordering both the current style impeller and current style volute.

■ – Factory recommended spare parts.

†Consult factory for delivery.

NOTE: All Bronze Series 1510 Pumps are obsolete.

1¹/₄AC

ITEM NO.	DESCRIPTION	PUMP CONSTRUCTION		
		BRONZE FITTED	BRONZE FITTED W/WEAR RING	ALL IRON
1	Volute	P41612	P44141*	P41612
	Wear Ring	—	P46700	—
	Volute Drain Plug (4)	P39020	P39020	P39030
5	Volute Capscrew (8)	P40020	P40020	P40020
3	Volute Gasket	P57700	P57700	P57700
17	Coupler Key (Straight) Aug. 1989 (H98) and After	P49373	P49373	P49373
17	Coupler Key (Woodruff) July 1989 (G98) and Before	H32600	H32600	H32600
	Seal or Packing	See Table A, B, C or D, Page 55		
16	Coupler	See Coupler Selection Table, Page 53		
ANSI/OSHA Coupling Guard & Support Bracket Kit Selection, See Page 54				
2	Impeller (State Diameter) 7" Full Dia.	P50652	P50652	P50662 [†]
8	Impeller Capscrew	P52350	P52350	P52350
9	Impeller Lockwasher	J23874	J23874	J23874
10	Impeller Washer	P46380	P46380	P46381
20	Impeller Key (Straight) Aug. 1989 (H98) and After	P49369	P49369	P49369
20	Impeller Key (Woodruff) July 1989 (G98) and Before	H32500	H32500	H32500
4	Volute Coverplate	P85027	P85027	P85027
44	Bracket	P85023	P85023	P85023
18	Bearing Frame Assembly Consisting of:	185321	185321	185321
33	Bearing Frame	P85014	P85014	P85014
35	Shaft	P85017	P85017	P85017
36	Bearing Cap	P85020	P85020	P85020
41	Ball Bearing – Pump End	186002	186002	186002
42	Ball Bearing – Coupler End	186001	186001	186001
27	i-ALERT Condition Monitor	185400	185400	185400
34	Spring Washer	J92558	J92558	J92558
37	Bearing Cap Capscrew (4)	P32000	P32000	P32000
19	Water Slinger	P53550	P53550	P53550

*Includes Wear Ring.

■ – Factory recommended spare parts.

[†]Consult factory for delivery.

NOTE: All Bronze Series 1510 Pumps are obsolete.

1^{1/2}AB

ITEM NO.	DESCRIPTION	PUMP CONSTRUCTION		
		BRONZE FITTED	BRONZE FITTED W/WEAR RING	ALL IRON
1	Volute	P41690	N/A**	P41690
	Wear Ring	—	P48660	—
	Volute Drain Plug (4)	P39020	P39020	P39030
5	Volute Capscrew (8)	P40020	P40020	P40020
3	Volute Gasket	P57700	P57700	P57700
17	Coupler Key (Straight) Aug. 1989 (H98) and After	P49373	P49373	P49373
17	Coupler Key (Woodruff) July 1989 (G98) and Before	H32600	H32600	H32600
	Seal or Packing	See Table A, B, C or D, Page 55		
16	Coupler	See Coupler Selection Table, Page 53		
ANSI/OSHA Coupling Guard & Support Bracket Kit Selection, See Page 54				
2	Impeller (State Diameter) 7" Full Dia.	P47950 [†]	P47950 [†]	P47810 [†]
8	Impeller Capscrew	P52350	P52350	P52350
9	Impeller Lockwasher	J23874	J23874	J23874
10	Impeller Washer	P46380	P46380	P46381
20	Impeller Key (Straight) Aug. 1989 (H98) and After	P49369	P49369	P49369
20	Impeller Key (Woodruff) July 1989 (G98) and Before	H32500	H32500	H32500
4	Volute Coverplate	P85027	P85027	P85027
44	Bracket	P85023	P85023	P85023
18	Bearing Frame Assembly Consisting of:	185321	185321	185321
33	Bearing Frame	P85014	P85014	P85014
35	Shaft	P85017	P85017	P85017
36	Bearing Cap	P85020	P85020	P85020
41	Ball Bearing – Pump End	186002	186002	186002
42	Ball Bearing – Coupler End	186001	186001	186001
27	i-ALERT Condition Monitor	185400	185400	185400
34	Spring Washer	J92558	J92558	J92558
37	Bearing Cap Capscrew (4)	P32000	P32000	P32000
19	Water Slinger	P53550	P53550	P53550

N/A — NO LONGER AVAILABLE

**The impeller and/or volute are no longer available. This pump can be converted to the current style pump by ordering both the current style impeller and current style volute.

— Factory recommended spare parts.

[†]Consult factory for delivery.

NOTE: All Bronze Series 1510 Pumps are obsolete.

1 1/2AC

ITEM NO.	DESCRIPTION	PUMP CONSTRUCTION		
		BRONZE FITTED	BRONZE FITTED W/WEAR RING	ALL IRON
1	Volute	P45473	P45475*	P45473
	Wear Ring	—	P48660	—
	Volute Drain Plug (4)	P39020	P39020	P39030
5	Volute Capscrew (8)	P40020	P40020	P40020
3	Volute Gasket	P57700	P57700	P57700
17	Coupler Key (Straight) Aug. 1989 (H98) and After	P49373	P49373	P49373
17	Coupler Key (Woodruff) July 1989 (G98) and Before	H32600	H32600	H32600
	Seal or Packing	See Table A, B, C or D, Page 55		
16	Coupler	See Coupler Selection Table, Page 53		
ANSI/OSHA Coupling Guard & Support Bracket Kit Selection, See Page 54				
2	Impeller (State Diameter) 7" Full Dia.	P45492	P45492	P45495
8	Impeller Capscrew	P52350	P52350	P52350
9	Impeller Lockwasher	J23874	J23874	J23874
10	Impeller Washer	P46380	P46380	P46381
20	Impeller Key (Straight) Aug. 1989 (H98) and After	P49369	P49369	P49369
20	Impeller Key (Woodruff) July 1989 (G98) and Before	H32500	H32500	H32500
4	Volute Coverplate	P85027	P85027	P85027
44	Bracket	P85023	P85023	P85023
18	Bearing Frame Assembly Consisting of:	185321	185321	185321
33	Bearing Frame	P85014	P85014	P85014
35	Shaft	P85017	P85017	P85017
36	Bearing Cap	P85020	P85020	P85020
41	Ball Bearing – Pump End	186002	186002	186002
42	Ball Bearing – Coupler End	186001	186001	186001
27	i-ALERT Condition Monitor	185400	185400	185400
34	Spring Washer	J92558	J92558	J92558
37	Bearing Cap Capscrew (4)	P32000	P32000	P32000
19	Water Slinger	P53550	P53550	P53550

*Includes Wear Ring.

■ – Factory recommended spare parts.

†Consult factory for delivery.

2AB

ITEM NO.	DESCRIPTION	PUMP CONSTRUCTION		
		BRONZE FITTED	BRONZE FITTED W/WEAR RING	ALL IRON
1	Volute	N/A**	N/A**	N/A**
	Wear Ring	—	P48660	—
	Volute Drain Plug (4)	P39040	P39040	P39050
5	Volute Capscrew (8)	P40020	P40020	P40020
3	Volute Gasket	P57700	P57700	P57700
17	Coupler Key (Straight) Aug. 1989 (H98) and After	P49373	P49373	P49373
17	Coupler Key (Woodruff) July 1989 (G98) and Before	H32600	H32600	H32600
	Seal or Packing	See Table A, B, C or D, Page 55		
16	Coupler	See Coupler Selection Table, Page 53		
ANSI/OSHA Coupling Guard & Support Bracket Kit Selection, See Page 54				
2	Impeller (State Diameter) 7" Full Dia.	P47950 [†]	P47950 [†]	P47810 [†]
8	Impeller Capscrew	P52350	P52350	P52350
9	Impeller Lockwasher	J23874	J23874	J23874
10	Impeller Washer	P46380	P46380	P46381
20	Impeller Key (Straight) Aug. 1989 (H98) and After	P49369	P49369	P49369
20	Impeller Key (Woodruff) July 1989 (G98) and Before	H32500	H32500	H32500
4	Volute Coverplate	P85027	P85027	P85027
44	Bracket	P85023	P85023	P85023
18	Bearing Frame Assembly Consisting of:	185321	185321	185321
33	Bearing Frame	P85014	P85014	P85014
35	Shaft	P85017	P85017	P85017
36	Bearing Cap	P85020	P85020	P85020
41	Ball Bearing – Pump End	186002	186002	186002
42	Ball Bearing – Coupler End	186001	186001	186001
27	i-ALERT Condition Monitor	185400	185400	185400
34	Spring Washer	J92558	J92558	J92558
37	Bearing Cap Capscrew (4)	P32000	P32000	P32000
19	Water Slinger	P53550	P53550	P53550

N/A — NO LONGER AVAILABLE

**The impeller and/or volute are no longer available. This pump can be converted to the current style pump by ordering both the current style impeller and current style volute.

■ — Factory recommended spare parts.

[†]Consult factory for delivery.

NOTE: All Bronze Series 1510 Pumps are obsolete.

2AC

ITEM NO.	DESCRIPTION	PUMP CONSTRUCTION		
		BRONZE FITTED	BRONZE FITTED W/WEAR RING	ALL IRON
PARTS COMMON TO BOTH SIZE PUMPS				
1	Volute	P42254	P44143*	P42254
	Wear Ring	—	P49145	—
	Volute Drain Plug (4)	P39040	P39040	P39050
3	Volute Gasket	P57700	P57700	P57700
17	Coupler Key (Straight) Aug. 1989 (H98) and After	P49373	P49373	P49373
17	Coupler Key (Woodruff) July 1989 (G98) and Before	H32600	H32600	H32600
	Seal or Packing	See Table A, B, C or D, Page 55		
16	Coupler	See Coupler Selection Table, Page 53		
ANSI/OSHA Coupling Guard & Support Bracket Kit Selection, See Page 54				
PARTS FOR PUMPS WITH 1 1/4" SHAFT AT SEAL				
2	Impeller (State Diameter) 7" Full Dia.	P50684	P50684	P50696 [†]
8	Impeller Capscrew	P52350	P52350	P52350
9	Impeller Lockwasher	J23874	J23874	J23874
10	Impeller Washer	P46380	P46380	P46381
20	Impeller Key (Straight) Aug. 1989 (H98) and After	P49369	P49369	P49369
20	Impeller Key (Woodruff) July 1989 (G98) and Before	H32500	H32500	H32500
5	Volute Capscrew (8)	P40020	P40020	P40020
4	Volute Coverplate	P85027	P85027	P85027
44	Bracket	P85023	P85023	P85023
18	Bearing Frame Assembly Consisting of:	185321	185321	185321
33	Bearing Frame	P85014	P85014	P85014
35	Shaft	P85017	P85017	P85017
36	Bearing Cap	P85020	P85020	P85020
41	Ball Bearing – Pump End	186002	186002	186002
42	Ball Bearing – Coupler End	186001	186001	186001
27	i-ALERT Condition Monitor	185400	185400	185400
34	Spring Washer	J92558	J92558	J92558
37	Bearing Cap Capscrew (4)	P32000	P32000	P32000
19	Water Slinger	P53550	P53550	P53550
PARTS FOR PUMPS WITH 1 5/8" SHAFT AT SEAL				
2	Impeller (State Diameter) 7" Full Dia.	P50692	P50692	P50698 [†]
8	Impeller Capscrew	P13800	P13800	P13800
9	Impeller Lockwasher	J23875	J23875	J23875
10	Impeller Washer	P51230	P51230	P46382
20	Impeller Key (Straight) Aug. 1989 (H98) and After	P49372	P49372	P49372
	Impeller Key (Woodruff) July 1989 (G98) and Before	H32700	H32700	H32700
5	Volute Capscrew (8)	DJ0081	DJ0081	DJ0081
4	Volute Coverplate	P85035	P85035	P85035
44	Bracket	P85025	P85025	P85025
18	Bearing Frame Assembly Consisting of:	185323	185323	185323
33	Bearing Frame	P85016	P85016	P85016
35	Shaft	P85018	P85018	P85018
36	Bearing Cap	P85065	P85065	P85065
41	Ball Bearing – Pump End	186571	186571	186571
42	Ball Bearing – Coupler End	186572	186572	186572
27	i-ALERT Condition Monitor	185400	185400	185400
34	Spring Washer	J92560	J92560	J92560
37	Bearing Cap Capscrew (4)	DJ0034	DJ0034	DJ0034
19	Water Slinger	P77320	P77320	P77320

*Includes Wear Ring.

■ – Factory recommended spare parts.

[†]Consult factory for delivery.

***All Bronze Series 1510 Pumps are obsolete. Consult factory on availability of replacement parts.

2¹/₂A

ITEM NO.	DESCRIPTION	PUMP CONSTRUCTION		
		BRONZE FITTED	BRONZE FITTED W/WEAR RING	ALL IRON
1	Volute	N/A**	N/A**	N/A**
	Wear Ring	—	N/A	—
	Volute Drain Plug (4)	P39040	P39040	P39050
5	Volute Capscrew (8)	P40020	P40020	P40020
3	Volute Gasket	P57700	P57700	P57700
17	Coupler Key (Straight) Aug. 1989 (H98) and After	P49373	P49373	P49373
17	Coupler Key (Woodruff) July 1989 (G98) and Before	H32600	H32600	H32600
	Seal or Packing	See Table A, B, C or D, Page 55		
16	Coupler	See Coupler Selection Table, Page 53		
ANSI/OSHA Coupling Guard & Support Bracket Kit Selection, See Page 54				
2	Impeller (State Diameter)	P49000 [†]	P49000 [†]	N/A**
8	Impeller Capscrew	P52350	P52350	P52350
9	Impeller Lockwasher	J23874	J23874	J23874
10	Impeller Washer	P46380	P46380	P46381
20	Impeller Key (Straight) Aug. 1989 (H98) and After	P49369	P49369	P49369
20	Impeller Key (Woodruff) July 1989 (G98) and Before	H32500	H32500	H32500
4	Volute Coverplate	P85027	P85027	P85027
44	Bracket	P85023	P85023	P85023
18	Bearing Frame Assembly Consisting of:	185321	185321	185321
33	Bearing Frame	P85014	P85014	P85014
35	Shaft	P85017	P85017	P85017
36	Bearing Cap	P85020	P85020	P85020
41	Ball Bearing – Pump End	186002	186002	186002
42	Ball Bearing – Coupler End	186001	186001	186001
27	i-ALERT Condition Monitor	185400	185400	185400
34	Spring Washer	J92558	J92558	J92558
37	Bearing Cap Capscrew (4)	P32000	P32000	P32000
19	Water Slinger	P53550	P53550	P53550

N/A — NO LONGER AVAILABLE

**The impeller and/or volute are no longer available. This pump can be converted to the current style pump by ordering both the current style impeller and current style volute.

■ – Factory recommended spare parts.

[†]Consult factory for delivery.

NOTE: All Bronze Series 1510 Pumps are obsolete.

2 1/2 AB

ITEM NO.	DESCRIPTION	PUMP CONSTRUCTION		
		BRONZE FITTED	BRONZE FITTED W/WEAR RING	ALL IRON
PARTS COMMON TO BOTH SIZE PUMPS				
1	Volute	P42532	P44145*	P42532
	Wear Ring	—	P85399	—
	Volute Drain Plug (4)	P39040	P39040	P39050
3	Volute Gasket	P57700	P57700	P57700
17	Coupler Key (Straight) Aug. 1989 (H98) and After	P49373	P49373	P49373
17	Coupler Key (Woodruff) July 1989 (G98) and Before	H32600	H32600	H32600
	Seal or Packing	See Table A, B, C or D, Page 55		
16	Coupler	See Coupler Selection Table, Page 53		
ANSI/OSHA Coupling Guard & Support Bracket Kit Selection, See Page 54				
PARTS FOR PUMPS WITH 1 1/4" SHAFT AT SEAL				
2	Impeller (State Diameter) 7" Full Dia.	P50716	P50716	P50727 [†]
8	Impeller Capscrew	P52350	P52350	P52350
9	Impeller Lockwasher	J23874	J23874	J23874
10	Impeller Washer	P46380	P46380	P46381
20	Impeller Key (Straight) Aug. 1989 (H98) and After	P49369	P49369	P49369
20	Impeller Key (Woodruff) July 1989 (G98) and Before	H32500	H32500	H32500
5	Volute Capscrew (8)	P40020	P40020	P40020
4	Volute Coverplate	P85027	P85027	P85027
44	Bracket	P85023	P85023	P85023
18	Bearing Frame Assembly Consisting of:	185321	185321	185321
33	Bearing Frame	P85014	P85014	P85014
35	Shaft	P85017	P85017	P85017
36	Bearing Cap	P85020	P85020	P85020
41	Ball Bearing – Pump End	186002	186002	186002
42	Ball Bearing – Coupler End	186001	186001	186001
27	i-ALERT Condition Monitor	185400	185400	185400
34	Spring Washer	J92558	J92558	J92558
37	Bearing Cap Capscrew (4)	P32000	P32000	P32000
19	Water Slinger	P53550	P53550	P53550
PARTS FOR PUMPS WITH 1 5/8" SHAFT AT SEAL				
2	Impeller (State Diameter) 7" Full Dia.	P50723	P50723	P50729 [†]
8	Impeller Capscrew	P13800	P13800	P13800
9	Impeller Lockwasher	J23875	J23875	J23875
10	Impeller Washer	P51230	P51230	P46382
20	Impeller Key (Straight) Aug. 1989 (H98) and After	P49372	P49372	P49372
20	Impeller Key (Woodruff) July 1989 (G98) and Before	H32700	H32700	H32700
5	Volute Capscrew (8)	DJ0081	DJ0081	DJ0081
4	Volute Coverplate	P85035	P85035	P85035
44	Bracket	P85025	P85025	P85025
18	Bearing Frame Assembly Consisting of:	185323	185323	185323
33	Bearing Frame	P85016	P85016	P85016
35	Shaft	P85018	P85018	P85018
36	Bearing Cap	P85065	P85065	P85065
41	Ball Bearing – Pump End	186571	186571	186571
42	Ball Bearing – Coupler End	186572	186572	186572
27	i-ALERT Condition Monitor	185400	185400	185400
34	Spring Washer	J92560	J92560	J92560
37	Bearing Cap Capscrew (4)	DJ0034	DJ0034	DJ0034
19	Water Slinger	P77320	P77320	P77320

*Includes Wear Ring.

■ – Factory recommended spare parts.

[†]Consult factory for delivery.

NOTE: All Bronze Series 1510 Pumps are obsolete.

3AB

ITEM NO.	DESCRIPTION	PUMP CONSTRUCTION		
		BRONZE FITTED	BRONZE FITTED W/WEAR RING	ALL IRON
PARTS COMMON TO BOTH SIZE PUMPS				
1	Volute	P42970	P43859*	P42970
	Wear Ring	—	P50650	—
	Volute Drain Plug (4)	P39040	P39040	P39050
3	Volute Gasket	P57700	P57700	P57700
17	Coupler Key (Straight) Aug. 1989 (H98) and After	P49373	P49373	P49373
17	Coupler Key (Woodruff) July 1989 (G98) and Before	H32600	H32600	H32600
	Seal or Packing	See Table A, B, C or D, Page 55		
16	Coupler	See Coupler Selection Table, Page 53		
ANSI/OSHA Coupling Guard & Support Bracket Kit Selection, See Page 54				
PARTS FOR PUMPS WITH 1 1/4" SHAFT AT SEAL				
2	Impeller (State Diameter) 7" Full Dia.	P78280†	P78280†	P78310†
8	Impeller Capscrew	P52350	P52350	P52350
9	Impeller Lockwasher	J23874	J23874	J23874
10	Impeller Washer	P46380	P46380	P46381
20	Impeller Key (Straight) Aug. 1989 (H98) and After	P49369	P49369	P49369
20	Impeller Key (Woodruff) July 1989 (G98) and Before	H32500	H32500	H32500
5	Volute Capscrew (8)	P40020	P40020	P40020
4	Volute Coverplate	P85027	P85027	P85027
44	Bracket	P85023	P85023	P85023
18	Bearing Frame Assembly Consisting of:	185321	185321	185321
33	Bearing Frame	P85014	P85014	P85014
35	Shaft	P85017	P85017	P85017
36	Bearing Cap	P85020	P85020	P85020
41	Ball Bearing – Pump End	186002	186002	186002
42	Ball Bearing – Coupler End	186001	186001	186001
27	i-ALERT Condition Monitor	185400	185400	185400
34	Spring Washer	J92558	J92558	J92558
37	Bearing Cap Capscrew (4)	P32000	P32000	P32000
19	Water Slinger	P53550	P53550	P53550
PARTS FOR PUMPS WITH 1 5/8" SHAFT AT SEAL				
2	Impeller (State Diameter) 7" Full Dia.	P77590†	P77590†	P77620†
8	Impeller Capscrew	P13800	P13800	P13800
9	Impeller Lockwasher	J23875	J23875	J23875
10	Impeller Washer	P51230	P51230	P46382
20	Impeller Key (Straight) Aug. 1989 (H98) and After	P49372	P49372	P49372
20	Impeller Key (Woodruff) July 1989 (G98) and Before	H32700	H32700	H32700
5	Volute Capscrew (8)	DJ0081	DJ0081	DJ0081
4	Volute Coverplate	P85035	P85035	P85035
44	Bracket	P85025	P85025	P85025
18	Bearing Frame Assembly Consisting of:	185323	185323	185323
33	Bearing Frame	P85016	P85016	P85016
35	Shaft	P85018	P85018	P85018
36	Bearing Cap	P85065	P85065	P85065
41	Ball Bearing – Pump End	186571	186571	186571
42	Ball Bearing – Coupler End	186572	186572	186572
27	i-ALERT Condition Monitor	185400	185400	185400
34	Spring Washer	J92560	J92560	J92560
37	Bearing Cap Capscrew (4)	DJ0034	DJ0034	DJ0034
19	Water Slinger	P77320	P77320	P77320

*Includes Wear Ring.

■ – Factory recommended spare parts.

†Consult factory for delivery.

NOTE: All Bronze Series 1510 Pumps are obsolete.

3AC

ITEM NO.	DESCRIPTION	PUMP CONSTRUCTION		
		BRONZE FITTED	BRONZE FITTED W/WEAR RING	ALL IRON
PARTS COMMON TO BOTH SIZE PUMPS				
1	Volute	P42970	P43859*	P42970
	Wear Ring	—	P50650	—
	Volute Drain Plug (4)	P39040	P39040	P39050
3	Volute Gasket	P57700	P57700	P57700
17	Coupler Key (Straight) Aug. 1989 (H98) and After	P49373	P49373	P49373
17	Coupler Key (Woodruff) July 1989 (G98) and Before	H32600	H32600	H32600
	Seal or Packing	See Table A, B, C or D, Page 55		
16	Coupler	See Coupler Selection Table, Page 53		
ANSI/OSHA Coupling Guard & Support Bracket Kit Selection, See Page 54				
PARTS FOR PUMPS WITH 1 1/4" SHAFT AT SEAL				
2	Impeller (State Diameter) 7" Full Dia.	P71561 [†]	P71561 [†]	P71567 [†]
8	Impeller Capscrew	P52350	P52350	P52350
9	Impeller Lockwasher	J23874	J23874	J23874
10	Impeller Washer	P46380	P46380	P46381
20	Impeller Key (Straight) Aug. 1989 (H98) and After	P49369	P49369	P49369
20	Impeller Key (Woodruff) July 1989 (G98) and Before	H32500	H32500	H32500
5	Volute Capscrew (8)	P40020	P40020	P40020
4	Volute Coverplate	P85027	P85027	P85027
44	Bracket	P85023	P85023	P85023
18	Bearing Frame Assembly Consisting of:	185321	185321	185321
33	Bearing Frame	P85014	P85014	P85014
35	Shaft	P85017	P85017	P85017
36	Bearing Cap	P85020	P85020	P85020
41	Ball Bearing – Pump End	186002	186002	186002
42	Ball Bearing – Coupler End	186001	186001	186001
27	i-ALERT Condition Monitor	185400	185400	185400
34	Spring Washer	J92558	J92558	J92558
37	Bearing Cap Capscrew (4)	P32000	P32000	P32000
19	Water Slinger	P53550	P53550	P53550
PARTS FOR PUMPS WITH 1 5/8" SHAFT AT SEAL				
2	Impeller (State Diameter) 7" Full Dia.	P71564 [†]	P71564 [†]	P71570 [†]
8	Impeller Capscrew	P13800	P13800	P13800
9	Impeller Lockwasher	J23875	J23875	J23875
10	Impeller Washer	P51230	P51230	P46382
20	Impeller Key (Straight) Aug. 1989 (H98) and After	P49372	P49372	P49372
20	Impeller Key (Woodruff) July 1989 (G98) and Before	H32700	H32700	H3270
5	Volute Capscrew (8)	DJ0081	DJ0081	DJ0081
4	Volute Coverplate	P85035	P85035	P85035
44	Bracket	P85025	P85025	P85025
18	Bearing Frame Assembly Consisting of:	185323	185323	185323
33	Bearing Frame	P85016	P85016	P85016
35	Shaft	P85018	P85018	P85018
36	Bearing Cap	P85065	P85065	P85065
41	Ball Bearing – Pump End	186571	186571	186571
42	Ball Bearing – Coupler End	186572	186572	186572
27	i-ALERT Condition Monitor	185400	185400	185400
34	Spring Washer	J92560	J92560	J92560
37	Bearing Cap Capscrew (4)	DJ0034	DJ0034	DJ0034
19	Water Slinger	P77320	P77320	P77320

*Includes Wear Ring.

■ – Factory recommended spare parts.

[†]Consult factory for delivery.

NOTE: All Bronze Series 1510 Pumps are obsolete.

4AB

ITEM NO.	DESCRIPTION	PUMP CONSTRUCTION		
		BRONZE FITTED	BRONZE FITTED W/WEAR RING	ALL IRON
PARTS COMMON TO BOTH SIZE PUMPS				
1	Volute	N/A**	N/A**	N/A**
	Wear Ring	—	P50590	—
	Volute Drain Plug (4)	P39040	P39040	P39050
3	Volute Gasket	P57700	P57700	P57700
17	Coupler Key (Straight) Aug. 1989 (H98) and After	P49373	P49373	P49373
17	Coupler Key (Woodruff) July 1989 (G98) and Before	H32600	H32600	H32600
	Seal or Packing	See Table A, B, C or D, Page 55		
16	Coupler	See Coupler Selection Table, Page 53		
ANSI/OSHA Coupling Guard & Support Bracket Kit Selection, See Page 54				
PARTS FOR PUMPS WITH 1 1/4" SHAFT AT SEAL				
2	Impeller (State Diameter) 7" Full Dia.	P56140 [†]	P56140 [†]	N/A**
8	Impeller Capscrew	P52350	P52350	P52350
9	Impeller Lockwasher	J23874	J23874	J23874
10	Impeller Washer	P46380	P46380	P46381
20	Impeller Key (Straight) Aug. 1989 (H98) and After	P49369	P49369	P49369
20	Impeller Key (Woodruff) July 1989 (G98) and Before	H32500	H32500	H32500
5	Volute Capscrew (8)	P40020	P40020	P40020
4	Volute Coverplate	P85027	P85027	P85027
44	Bracket	P85023	P85023	P85023
18	Bearing Frame Assembly Consisting of:	185321	185321	185321
33	Bearing Frame	P85014	P85014	P85014
35	Shaft	P85017	P85017	P85017
36	Bearing Cap	P85020	P85020	P85020
41	Ball Bearing – Pump End	186002	186002	186002
42	Ball Bearing – Coupler End	186001	186001	186001
27	i-ALERT Condition Monitor	185400	185400	185400
34	Spring Washer	J92558	J92558	J92558
37	Bearing Cap Capscrew (4)	P32000	P32000	P32000
19	Water Slinger	P53550	P53550	P53550
PARTS FOR PUMPS WITH 1 5/8" SHAFT AT SEAL				
2	Impeller (State Diameter) 7" Full Dia.	P50310 [†]	P50310 [†]	N/A**
8	Impeller Capscrew	P13800	P13800	P13800
9	Impeller Lockwasher	J23875	J23875	J23875
10	Impeller Washer	P51230	P51230	P46382
20	Impeller Key (Straight) Aug. 1989 (H98) and After	P49372	P49372	P49372
20	Impeller Key (Woodruff) July 1989 (G98) and Before	H32700	H32700	H32700
5	Volute Capscrew (8)	DJ0081	DJ0081	DJ0081
4	Volute Coverplate	P85035	P85035	P85035
44	Bracket	P85025	P85025	P85025
18	Bearing Frame Assembly Consisting of:	185323	185323	185323
33	Bearing Frame	P85016	P85016	P85016
35	Shaft	P85018	P85018	P85018
36	Bearing Cap	P85065	P85065	P85065
41	Ball Bearing – Pump End	186571	186571	186571
42	Ball Bearing – Coupler End	186572	186572	186572
27	i-ALERT Condition Monitor	185400	185400	185400
34	Spring Washer	J92560	J92560	J92560
37	Bearing Cap Capscrew (4)	DJ0034	DJ0034	DJ0034
19	Water Slinger	P77320	P77320	P77320

N/A — NO LONGER AVAILABLE

**The impeller and/or volute are no longer available. This pump can be converted to the current style pump by ordering both the current style impeller and current style volute.

■ — Factory recommended spare parts.

[†]Consult factory for delivery.

NOTE: All Bronze Series 1510 Pumps are obsolete.

4AC

ITEM NO.	DESCRIPTION	PUMP CONSTRUCTION		
		BRONZE FITTED	BRONZE FITTED W/WEAR RING	ALL IRON
PARTS COMMON TO BOTH SIZE PUMPS				
1	Volute	P43252	P43861*	P43252
	Wear Ring	—	P49141	—
	Volute Drain Plug (4)	P39040	P39040	P39050
3	Volute Gasket	P57700	P57700	P57700
17	Coupler Key (Straight) Aug. 1989 (H98) and After	P49373	P49373	P49373
17	Coupler Key (Woodruff) July 1989 (G98) and Before	H32600	H32600	H32600
	Seal or Packing	See Table A, B, C or D, Page 55		
16	Coupler	See Coupler Selection Table, Page 53		
ANSI/OSHA Coupling Guard & Support Bracket Kit Selection, See Page 54				
PARTS FOR PUMPS WITH 1 1/4" SHAFT AT SEAL				
2	Impeller (State Diameter) 7" Full Dia.	P50762	P50762	P50764 [†]
8	Impeller Capscrew	P52350	P52350	P52350
9	Impeller Lockwasher	J23874	J23874	J23874
10	Impeller Washer	P46380	P46380	P46381
20	Impeller Key (Straight) Aug. 1989 (H98) and After	P49369	P49369	P49369
20	Impeller Key (Woodruff) July 1989 (G98) and Before	H32500	H32500	H32500
5	Volute Capscrew (8)	P40020	P40020	P40020
4	Volute Coverplate	P85027	P85027	P85027
44	Bracket	P85023	P85023	P85023
18	Bearing Frame Assembly Consisting of:	185321	185321	185321
33	Bearing Frame	P85014	P85014	P85014
35	Shaft	P85017	P85017	P85017
36	Bearing Cap	P85020	P85020	P85020
41	Ball Bearing – Pump End	186002	186002	186002
42	Ball Bearing – Coupler End	186001	186001	186001
27	i-ALERT Condition Monitor	185400	185400	185400
34	Spring Washer	J92558	J92558	J92558
37	Bearing Cap Capscrew (4)	P32000	P32000	P32000
19	Water Slinger	P53550	P53550	P53550
PARTS FOR PUMPS WITH 1 5/8" SHAFT AT SEAL				
2	Impeller (State Diameter) 7" Full Dia.	P50772	P50772	P50774 [†]
8	Impeller Capscrew	P13800	P13800	P13800
9	Impeller Lockwasher	J23875	J23875	J23875
10	Impeller Washer	P51230	P51230	P46382
20	Impeller Key (Straight) Aug. 1989 (H98) and After	P49372	P49372	P49372
20	Impeller Key (Woodruff) July 1989 (G98) and Before	H32700	H32700	H32700
5	Volute Capscrew (8)	DJ0081	DJ0081	DJ0081
4	Volute Coverplate	P85035	P85035	P85035
44	Bracket	P85025	P85025	P85025
18	Bearing Frame Assembly Consisting of:	185323	185323	185323
33	Bearing Frame	P85016	P85016	P85016
35	Shaft	P85018	P85018	P85018
36	Bearing Cap	P85065	P85065	P85065
41	Ball Bearing – Pump End	186571	186571	186571
42	Ball Bearing – Coupler End	186572	186572	186572
27	i-ALERT Condition Monitor	185400	185400	185400
34	Spring Washer	J92560	J92560	J92560
37	Bearing Cap Capscrew (4)	DJ0034	DJ0034	DJ0034
19	Water Slinger	P77320	P77320	P77320

*Includes Wear Ring.

■ – Factory recommended spare parts.

[†]Consult factory for delivery.

5A

ITEM NO.	DESCRIPTION	PUMP CONSTRUCTION		
		BRONZE FITTED	BRONZE FITTED W/WEAR RING	ALL IRON
PARTS COMMON TO BOTH SIZE PUMPS				
1	Volute	P43663	P43862*	P43663
	Wear Ring	—	P49142	—
	Volute Drain Plug (4)	P39040	P39040	P39050
3	Volute Gasket	P57700	P57700	P57700
17	Coupler Key (Straight) Aug. 1989 (H98) and After	P49373	P49373	P49373
17	Coupler Key (Woodruff) July 1989 (G98) and Before	H32600	H32600	H32600
	Seal or Packing	See Table A, B, C or D, Page 55		
16	Coupler	See Coupler Selection Table, Page 53		
ANSI/OSHA Coupling Guard & Support Bracket Kit Selection, See Page 54				
PARTS FOR PUMPS WITH 1 1/4" SHAFT AT SEAL				
2	Impeller (State Diameter) 7" Full Dia.	P50802	P50802	P50804†
8	Impeller Capscrew	P52350	P52350	P52350
9	Impeller Lockwasher	J23874	J23874	J23874
10	Impeller Washer	P46380	P46380	P46381
20	Impeller Key (Straight) Aug. 1989 (H98) and After	P49369	P49369	P49369
20	Impeller Key (Woodruff) July 1989 (G98) and Before	H32500	H32500	H32500
5	Volute Capscrew (8)	P40020	P40020	P40020
4	Volute Coverplate	P85027	P85027	P85027
44	Bracket	P85023	P85023	P85023
18	Bearing Frame Assembly Consisting of:	185321	185321	185321
33	Bearing Frame	P85014	P85014	P85014
35	Shaft	P85017	P85017	P85017
36	Bearing Cap	P85020	P85020	P85020
41	Ball Bearing – Pump End	186002	186002	186002
42	Ball Bearing – Coupler End	186001	186001	186001
27	i-ALERT Condition Monitor	185400	185400	185400
34	Spring Washer	J92558	J92558	J92558
37	Bearing Cap Capscrew (4)	P32000	P32000	P32000
19	Water Slinger	P53550	P53550	P53550
PARTS FOR PUMPS WITH 1 1/8" SHAFT AT SEAL				
2	Impeller (State Diameter) 7" Full Dia.	P50812	P50812	P50814†
8	Impeller Capscrew	P13800	P13800	P13800
9	Impeller Lockwasher	J23875	J23875	J23875
10	Impeller Washer	P51230	P51230	P46382
20	Impeller Key (Straight) Aug. 1989 (H98) and After	P49372	P49372	P49372
20	Impeller Key (Woodruff) July 1989 (G98) and Before	H32700	H32700	H32700
5	Volute Capscrew (8)	DJ0081	DJ0081	DJ0081
4	Volute Coverplate	P85035	P85035	P85035
44	Bracket	P85025	P85025	P85025
18	Bearing Frame Assembly Consisting of:	185323	185323	185323
33	Bearing Frame	P85016	P85016	P85016
35	Shaft	P85018	P85018	P85018
36	Bearing Cap	P85065	P85065	P85065
41	Ball Bearing – Pump End	186571	186571	186571
42	Ball Bearing – Coupler End	186572	186572	186572
27	i-ALERT Condition Monitor	185400	185400	185400
34	Spring Washer	J92560	J92560	J92560
37	Bearing Cap Capscrew (4)	DJ0034	DJ0034	DJ0034
19	Water Slinger	P77320	P77320	P77320

*Includes Wear Ring.

■ – Factory recommended spare parts.

†Consult factory for delivery.

1 1/4BB

ITEM NO.	DESCRIPTION	PUMP CONSTRUCTION		
		BRONZE FITTED	BRONZE FITTED W/WEAR RING	ALL IRON
PARTS COMMON TO BOTH SIZE PUMPS				
1	Volute	N/A**	N/A**	N/A**
	Wear Ring	—	P48660	—
	Volute Drain Plug (4)	P39020	P39020	P39030
5	Volute Capscrew (12)	P03470	P03470	P03470
3	Volute Gasket	P48690	P48690	P48690
17	Coupler Key (Straight) Aug. 1989 (H98) and After	P49373	P49373	P49373
17	Coupler Key (Woodruff) July 1989 (G98) and Before	H32600	H32600	H32600
	Seal or Packing	See Table A, B, C or D, Page 55		
16	Coupler	See Coupler Selection Table, Page 53		
ANSI/OSHA Coupling Guard & Support Bracket Kit Selection, See Page 54				
PARTS FOR PUMPS WITH 1 1/4" SHAFT AT SEAL				
2	Impeller (State Diameter) 9 1/2" Full Dia.	P78523	P78523	P78253 [†]
8	Impeller Capscrew	P52350	P52350	P52350
9	Impeller Lockwasher	J23874	J23874	J23874
10	Impeller Washer	P46380	P46380	P46381
20	Impeller Key (Straight) Aug. 1989 (H98) and After	P49369	P49369	P49369
20	Impeller Key (Woodruff) July 1989 (G98) and Before	H32500	H32500	H32500
4	Volute Coverplate	P85031	P85031	P85031
44	Bracket	P85023	P85023	P85023
18	Bearing Frame Assembly Consisting of:	185321	185321	185321
33	Bearing Frame	P85014	P85014	P85014
35	Shaft	P85017	P85017	P85017
36	Bearing Cap	P85020	P85020	P85020
41	Ball Bearing – Pump End	186002	186002	186002
42	Ball Bearing – Coupler End	186001	186001	186001
27	i-ALERT Condition Monitor	185400	185400	185400
34	Spring Washer	J92558	J92558	J92558
37	Bearing Cap Capscrew (4)	P32000	P32000	P32000
19	Water Slinger	P53550	P53550	P53550
PARTS FOR PUMPS WITH 1 5/8" SHAFT AT SEAL				
2	Impeller (State Diameter) 9 1/2" Full Dia.	P78251	P78251	P78522 [†]
8	Impeller Capscrew	P13800	P13800	P13800
9	Impeller Lockwasher	J23875	J23875	J23875
10	Impeller Washer	P51230	P51230	P46382
20	Impeller Key (Straight) Aug. 1989 (H98) and After	P49372	P49372	P49372
20	Impeller Key (Woodruff) July 1989 (G98) and Before	H32700	H32700	H32700
4	Volute Coverplate	P85039	P85039	P85039
44	Bracket	P85025	P85025	P85025
18	Bearing Frame Assembly Consisting of:	185323	185323	185323
33	Bearing Frame	P85016	P85016	P85016
35	Shaft	P85018	P85018	P85018
36	Bearing Cap	P85065	P85065	P85065
41	Ball Bearing – Pump End	186571	186571	186571
42	Ball Bearing – Coupler End	186572	186572	186572
27	i-ALERT Condition Monitor	185400	185400	185400
34	Spring Washer	J92560	J92560	J92560
37	Bearing Cap Capscrew (4)	DJ0034	DJ0034	DJ0034
19	Water Slinger	P77320	P77320	P77320

N/A — NO LONGER AVAILABLE

**The impeller and/or volute are no longer available. This pump can be converted to the current style pump by ordering both the current style impeller and current style volute.

■ — Factory recommended spare parts.

[†]Consult factory for delivery.

NOTE: All Bronze Series 1510 Pumps are obsolete.

1¹/₄BC

ITEM NO.	DESCRIPTION	PUMP CONSTRUCTION		
		BRONZE FITTED	BRONZE FITTED W/WEAR RING	ALL IRON
PARTS COMMON TO BOTH SIZE PUMPS				
1	Volute	P41620	P44142*	P41620
	Wear Ring	—	P46700	—
	Volute Drain Plug (4)	P39020	P39020	P39030
5	Volute Capscrew (12)	P03470	P03470	P03470
3	Volute Gasket	P48690	P48690	P48690
17	Coupler Key (Straight) Aug. 1989 (H98) and After	P49373	P49373	P49373
17	Coupler Key (Woodruff) July 1989 (G98) and Before	H32600	H32600	H32600
	Seal or Packing	See Table A, B, C or D, Page 55		
16	Coupler	See Coupler Selection Table, Page 53		
ANSI/OSHA Coupling Guard & Support Bracket Kit Selection, See Page 54				
PARTS FOR PUMPS WITH 1¹/₄" SHAFT AT SEAL				
2	Impeller (State Diameter) 9 ¹ / ₂ " Full Dia.	P50666	P50666	P50678 [†]
8	Impeller Capscrew	P52350	P52350	P52350
9	Impeller Lockwasher	J23874	J23874	J23874
10	Impeller Washer	P46380	P46380	P46381
20	Impeller Key (Straight) Aug. 1989 (H98) and After	P49369	P49369	P49369
20	Impeller Key (Woodruff) July 1989 (G98) and Before	H32500	H32500	H32500
4	Volute Coverplate	P85031	P85031	P85031
44	Bracket	P85023	P85023	P85023
18	Bearing Frame Assembly Consisting of:	185321	185321	185321
33	Bearing Frame	P85014	P85014	P85014
35	Shaft	P85017	P85017	P85017
36	Bearing Cap	P85020	P85020	P85020
41	Ball Bearing – Pump End	186002	186002	186002
42	Ball Bearing – Coupler End	186001	186001	186001
27	i-ALERT Condition Monitor	185400	185400	185400
34	Spring Washer	J92558	J92558	J92558
37	Bearing Cap Capscrew (4)	P32000	P32000	P32000
19	Water Slinger	P53550	P53550	P53550
PARTS FOR PUMPS WITH 1⁵/₈" SHAFT AT SEAL				
2	Impeller (State Diameter) 9 ¹ / ₂ " Full Dia.	P50674	P50674	P50682 [†]
8	Impeller Capscrew	P13800	P13800	P13800
9	Impeller Lockwasher	J23875	J23875	J23875
10	Impeller Washer	P51230	P51230	P46382
20	Impeller Key (Straight) Aug. 1989 (H98) and After	P49372	P49372	P49372
20	Impeller Key (Woodruff) July 1989 (G98) and Before	H32700	H32700	H32700
4	Volute Coverplate	P85039	P85039	P85039
44	Bracket	P85025	P85025	P85025
18	Bearing Frame Assembly Consisting of:	185323	185323	185323
33	Bearing Frame	P85016	P85016	P85016
35	Shaft	P85018	P85018	P85018
36	Bearing Cap	P85065	P85065	P85065
41	Ball Bearing – Pump End	186571	186571	186571
42	Ball Bearing – Coupler End	186572	186572	186572
27	i-ALERT Condition Monitor	185400	185400	185400
34	Spring Washer	J92560	J92560	J92560
37	Bearing Cap Capscrew (4)	DJ0034	DJ0034	DJ0034
19	Water Slinger	P77320	P77320	P77320

*Includes Wear Ring.

■ – Factory recommended spare parts.

[†]Consult factory for delivery.

NOTE: All Bronze Series 1510 Pumps are obsolete.

1^{1/2}BB & 1^{1/2}BC

ITEM NO.	DESCRIPTION	PUMP CONSTRUCTION		
		BRONZE FITTED	BRONZE FITTED W/WEAR RING	ALL IRON
PARTS COMMON TO BOTH SIZE PUMPS				
1	Volute	P41780	P44136*	P41780
	Wear Ring	—	P48660	—
	Volute Drain Plug (4)	P39020	P39020	P39030
5	Volute Capscrew (12)	P03470	P03470	P03470
3	Volute Gasket	P48690	P48690	P48690
17	Coupler Key (Straight) Aug. 1989 (H98) and After	P49373	P49373	P49373
17	Coupler Key (Woodruff) July 1989 (G98) and Before	H32600	H32600	H32600
	Seal or Packing	See Table A, B, C or D, Page 55		
16	Coupler	See Coupler Selection Table, Page 53		
ANSI/OSHA Coupling Guard & Support Bracket Kit Selection, See Page 54				
PARTS FOR PUMPS WITH 1^{1/4}" SHAFT AT SEAL				
2	Impeller (State Diameter) 9 ^{1/2} " Full Dia.	P78523	P78523	P78253 [†]
8	Impeller Capscrew	P52350	P52350	P52350
9	Impeller Lockwasher	J23874	J23874	J23874
10	Impeller Washer	P46380	P46380	P46381
20	Impeller Key (Straight) Aug. 1989 (H98) and After	P49369	P49369	P49369
20	Impeller Key (Woodruff) July 1989 (G98) and Before	H32500	H32500	H32500
4	Volute Coverplate	P85031	P85031	P85031
44	Bracket	P85023	P85023	P85023
18	Bearing Frame Assembly Consisting of:	185321	185321	185321
33	Bearing Frame	P85014	P85014	P85014
35	Shaft	P85017	P85017	P85017
36	Bearing Cap	P85020	P85020	P85020
41	Ball Bearing – Pump End	186002	186002	186002
42	Ball Bearing – Coupler End	186001	186001	186001
27	i-ALERT Condition Monitor	185400	185400	185400
34	Spring Washer	J92558	J92558	J92558
37	Bearing Cap Capscrew (4)	P32000	P32000	P32000
19	Water Slinger	P53550	P53550	P53550
PARTS FOR PUMPS WITH 1^{5/8}" SHAFT AT SEAL				
2	Impeller (State Diameter) 9 ^{1/2} " Full Dia.	P78251	P78251	P78522 [†]
8	Impeller Capscrew	P13800	P13800	P13800
9	Impeller Lockwasher	J23875	J23875	J23875
10	Impeller Washer	P51230	P51230	P46382
20	Impeller Key (Straight) Aug. 1989 (H98) and After	P49372	P49372	P49372
20	Impeller Key (Woodruff) July 1989 (G98) and Before	H32700	H32700	H32700
4	Volute Coverplate	P85039	P85039	P85039
44	Bracket	P85025	P85025	P85025
18	Bearing Frame Assembly Consisting of:	185323	185323	185323
33	Bearing Frame	P85016	P85016	P85016
35	Shaft	P85018	P85018	P85018
36	Bearing Cap	P85065	P85065	P85065
41	Ball Bearing – Pump End	186571	186571	186571
42	Ball Bearing – Coupler End	186572	186572	186572
27	i-ALERT Condition Monitor	185400	185400	185400
34	Spring Washer	J92560	J92560	J92560
37	Bearing Cap Capscrew (4)	DJ0034	DJ0034	DJ0034
19	Water Slinger	P77320	P77320	P77320

*Includes Wear Ring.

■ – Factory recommended spare parts.

[†]Consult factory for delivery.

NOTE: All Bronze Series 1510 Pumps are obsolete.

2BB

ITEM NO.	DESCRIPTION	PUMP CONSTRUCTION		
		BRONZE FITTED	BRONZE FITTED W/WEAR RING	ALL IRON
PARTS COMMON TO BOTH SIZE PUMPS				
1	Volute	N/A**	N/A**	N/A**
	Wear Ring	—	P49130	—
	Volute Drain Plug (4)	P39040	P39040	P39050
3	Volute Capscrew (12)	P03470	P03470	P03470
5	Volute Gasket	P48690	P48690	P48690
17	Coupler Key (Straight) Aug. 1989 (H98) and After	P49373	P49373	P49373
17	Coupler Key (Woodruff) July 1989 (G98) and Before	H32600	H32600	H32600
	Seal or Packing	See Table A, B, C or D, Page 55		
16	Coupler	See Coupler Selection Table, Page 53		
ANSI/OSHA Coupling Guard & Support Bracket Kit Selection, See Page 54				
PARTS FOR PUMPS WITH 1 1/4" SHAFT AT SEAL				
2	Impeller (State Diameter) 9 1/2" Full Dia.	P78525 [†]	P78525 [†]	P78486 [†]
8	Impeller Capscrew	P52350	P52350	P52350
9	Impeller Lockwasher	J23874	J23874	J23874
10	Impeller Washer	P46380	P46380	P46381
20	Impeller Key (Straight) Aug. 1989 (H98) and After	P49369	P49369	P49369
20	Impeller Key (Woodruff) July 1989 (G98) and Before	H32500	H32500	H32500
4	Volute Coverplate	P85031	P85031	P85031
44	Bracket	P85023	P85023	P85023
18	Bearing Frame Assembly Consisting of:	185321	185321	185321
33	Bearing Frame	P85014	P85014	P85014
35	Shaft	P85017	P85017	P85017
36	Bearing Cap	P85020	P85020	P85020
41	Ball Bearing – Pump End	186002	186002	186002
42	Ball Bearing – Coupler End	186001	186001	186001
27	i-ALERT Condition Monitor	185400	185400	185400
34	Spring Washer	J92558	J92558	J92558
37	Bearing Cap Capscrew (4)	P32000	P32000	P32000
19	Water Slinger	P53550	P53550	P53550
PARTS FOR PUMPS WITH 1 5/8" SHAFT AT SEAL				
2	Impeller (State Diameter) 9 1/2" Full Dia.	P78255 [†]	P78255 [†]	N/A**
8	Impeller Capscrew	P13800	P13800	P13800
9	Impeller Lockwasher	J23875	J23875	J23875
10	Impeller Washer	P51230	P51230	P46382
20	Impeller Key (Straight) Aug. 1989 (H98) and After	P49372	P49372	P49372
20	Impeller Key (Woodruff) July 1989 (G98) and Before	H32700	H32700	H32700
4	Volute Coverplate	P85039	P85039	P85039
44	Bracket	P85025	P85025	P85025
18	Bearing Frame Assembly Consisting of:	185323	185323	185323
33	Bearing Frame	P85016	P85016	P85016
35	Shaft	P85018	P85018	P85018
36	Bearing Cap	P85065	P85065	P85065
41	Ball Bearing – Pump End	186571	186571	186571
42	Ball Bearing – Coupler End	186572	186572	186572
27	i-ALERT Condition Monitor	185400	185400	185400
34	Spring Washer	J92560	J92560	J92560
37	Bearing Cap Capscrew (4)	DJ0034	DJ0034	DJ0034
19	Water Slinger	P77320	P77320	P77320

N/A — NO LONGER AVAILABLE

**The impeller and/or volute are no longer available. This pump can be converted to the current style pump by ordering both the current style impeller and current style volute.

■ — Factory recommended spare parts.

†Consult factory for delivery.

NOTE: All Bronze Series 1510 Pumps are obsolete.

2BC

ITEM NO.	DESCRIPTION	PUMP CONSTRUCTION		
		BRONZE FITTED	BRONZE FITTED W/WEAR RING	ALL IRON
PARTS COMMON TO BOTH SIZE PUMPS				
1	Volute	P42264	P44144*	P42264
	Wear Ring	—	P49130	—
	Volute Drain Plug (4)	P39040	P39040	P39050
5	Volute Capscrew (12)	P03470	P03470	P03470
3	Volute Gasket	P48690	P48690	P48690
17	Coupler Key (Straight) Aug. 1989 (H98) and After	P49373	P49373	P49373
17	Coupler Key (Woodruff) July 1989 (G98) and Before	H32600	H32600	H32600
	Seal or Packing	See Table A, B, C or D, Page 55		
16	Coupler	See Coupler Selection Table, Page 53		
ANSI/OSHA Coupling Guard & Support Bracket Kit Selection, See Page 54				
PARTS FOR PUMPS WITH 1 1/4" SHAFT AT SEAL				
2	Impeller (State Diameter) 9 1/2" Full Dia.	P50700	P50700	P50712 [†]
8	Impeller Capscrew	P52350	P52350	P52350
9	Impeller Lockwasher	J23874	J23874	J23874
10	Impeller Washer	P46380	P46380	P46381
20	Impeller Key (Straight) Aug. 1989 (H98) and After	P49369	P49369	P49369
20	Impeller Key (Woodruff) July 1989 (G98) and Before	H32500	H32500	H32500
4	Volute Coverplate	P85031	P85031	P85031
44	Bracket	P85023	P85023	P85023
18	Bearing Frame Assembly Consisting of:	185321	185321	185321
33	Bearing Frame	P85014	P85014	P85014
35	Shaft	P85017	P85017	P85017
36	Bearing Cap	P85020	P85020	P85020
41	Ball Bearing – Pump End	186002	186002	186002
42	Ball Bearing – Coupler End	186001	186001	186001
27	i-ALERT Condition Monitor	185400	185400	185400
34	Spring Washer	J92558	J92558	J92558
37	Bearing Cap Capscrew (4)	P32000	P32000	P32000
19	Water Slinger	P53550	P53550	P53550
PARTS FOR PUMPS WITH 1 5/8" SHAFT AT SEAL				
2	Impeller (State Diameter) 9 1/2" Full Dia.	P50707	P50707	P50714 [†]
8	Impeller Capscrew	P13800	P13800	P13800
9	Impeller Lockwasher	J23875	J23875	J23875
10	Impeller Washer	P51230	P51230	P46382
20	Impeller Key (Straight) Aug. 1989 (H98) and After	P49372	P49372	P49372
20	Impeller Key (Woodruff) July 1989 (G98) and Before	H32700	H32700	H32700
4	Volute Coverplate	P85039	P85039	P85039
44	Bracket	P85025	P85025	P85025
18	Bearing Frame Assembly Consisting of:	185323	185323	185323
33	Bearing Frame	P85016	P85016	P85016
35	Shaft	P85018	P85018	P85018
36	Bearing Cap	P85065	P85065	P85065
41	Ball Bearing – Pump End	186571	186571	186571
42	Ball Bearing – Coupler End	186572	186572	186572
27	i-ALERT Condition Monitor	185400	185400	185400
34	Spring Washer	J92560	J92560	J92560
37	Bearing Cap Capscrew (4)	DJ0034	DJ0034	DJ0034
19	Water Slinger	P77320	P77320	P77320

*Includes Wear Ring.

■ – Factory recommended spare parts.

[†]Consult factory for delivery.

NOTE: All Bronze Series 1510 Pumps are obsolete.

2¹/₂B

ITEM NO.	DESCRIPTION	PUMP CONSTRUCTION		
		BRONZE FITTED	BRONZE FITTED W/WEAR RING	ALL IRON
PARTS COMMON TO BOTH SIZE PUMPS				
1	Volute	N/A**	N/A**	N/A**
	Wear Ring	—	P49130	—
	Volute Drain Plug (4)	P39040	P39040	P39050
3	Volute Capscrew (12)	P03470	P03470	P03470
5	Volute Gasket	P48690	P48690	P48690
17	Coupler Key (Straight) Aug. 1989 (H98) and After	P49373	P49373	P49373
17	Coupler Key (Woodruff) July 1989 (G98) and Before	H32600	H32600	H32600
	Seal or Packing	See Table A, B, C or D, Page 55		
16	Coupler	See Coupler Selection Table, Page 53		
ANSI/OSHA Coupling Guard & Support Bracket Kit Selection, See Page 54				
PARTS FOR PUMPS WITH 1¹/₄" SHAFT AT SEAL				
2	Impeller (State Diameter) 9 ¹ / ₂ " Full Dia.	P78525 [†]	P78525 [†]	P78486 [†]
8	Impeller Capscrew	P52350	P52350	P52350
9	Impeller Lockwasher	J23874	J23874	J23874
10	Impeller Washer	P46380	P46380	P46381
20	Impeller Key (Straight) Aug. 1989 (H98) and After	P49369	P49369	P49369
20	Impeller Key (Woodruff) July 1989 (G98) and Before	H32500	H32500	H32500
4	Volute Coverplate	P85031	P85031	P85031
44	Bracket	P85023	P85023	P85023
18	Bearing Frame Assembly Consisting of:	185321	185321	185321
33	Bearing Frame	P85014	P85014	P85014
35	Shaft	P85017	P85017	P85017
36	Bearing Cap	P85020	P85020	P85020
41	Ball Bearing – Pump End	186002	186002	186002
42	Ball Bearing – Coupler End	186001	186001	186001
27	i-ALERT Condition Monitor	185400	185400	185400
34	Spring Washer	J92558	J92558	J92558
37	Bearing Cap Capscrew (4)	P32000	P32000	P32000
19	Water Slinger	P53550	P53550	P53550
PARTS FOR PUMPS WITH 1⁵/₈" SHAFT AT SEAL				
2	Impeller (State Diameter) 9 ¹ / ₂ " Full Dia.	P78255 [†]	P78255 [†]	N/A**
8	Impeller Capscrew	P13800	P13800	P13800
9	Impeller Lockwasher	J23875	J23875	J23875
10	Impeller Washer	P51230	P51230	P46382
20	Impeller Key (Straight) Aug. 1989 (H98) and After	P49372	P49372	P49372
20	Impeller Key (Woodruff) July 1989 (G98) and Before	H32700	H32700	H32700
4	Volute Coverplate	P85039	P85039	P85039
44	Bracket	P85025	P85025	P85025
18	Bearing Frame Assembly Consisting of:	185323	185323	185323
33	Bearing Frame	P85016	P85016	P85016
35	Shaft	P85018	P85018	P85018
36	Bearing Cap	P85065	P85065	P85065
41	Ball Bearing – Pump End	186571	186571	186571
42	Ball Bearing – Coupler End	186572	186572	186572
27	i-ALERT Condition Monitor	185400	185400	185400
34	Spring Washer	J92560	J92560	J92560
37	Bearing Cap Capscrew (4)	DJ0034	DJ0034	DJ0034
19	Water Slinger	P77320	P77320	P77320

N/A — NO LONGER AVAILABLE

**The impeller and/or volute are no longer available. This pump can be converted to the current style pump by ordering both the current style impeller and current style volute.

■ — Factory recommended spare parts.

†Consult factory for delivery.

NOTE: All Bronze Series 1510 Pumps are obsolete.

2 1/2 BB

ITEM NO.	DESCRIPTION	PUMP CONSTRUCTION		
		BRONZE FITTED	BRONZE FITTED W/WEAR RING	ALL IRON
PARTS COMMON TO BOTH SIZE PUMPS				
1	Volute	P42542	P44146*	P42542
	Wear Ring	—	P49870	—
	Volute Drain Plug (4)	P39040	P39040	P39050
5	Volute Capscrew (12)	P03470	P03470	P03470
3	Volute Gasket	P48690	P48690	P48690
17	Coupler Key (Straight) Aug. 1989 (H98) and After	P49373	P49373	P49373
17	Coupler Key (Woodruff) July 1989 (G98) and Before	H32600	H32600	H32600
	Seal or Packing	See Table A, B, C or D, Page 55		
16	Coupler	See Coupler Selection Table, Page 53		
ANSI/OSHA Coupling Guard & Support Bracket Kit Selection, See Page 54				
PARTS FOR PUMPS WITH 1 1/4" SHAFT AT SEAL				
2	Impeller (State Diameter) 9 1/2" Full Dia.	P50732	P50732	P50744 [†]
8	Impeller Capscrew	P52350	P52350	P52350
9	Impeller Lockwasher	J23874	J23874	J23874
10	Impeller Washer	P46380	P46380	P46381
20	Impeller Key (Straight) Aug. 1989 (H98) and After	P49369	P49369	P49369
20	Impeller Key (Woodruff) July 1989 (G98) and Before	H32500	H32500	H32500
4	Volute Coverplate	P85031	P85031	P85031
44	Bracket	P85023	P85023	P85023
18	Bearing Frame Assembly Consisting of:	185321	185321	185321
33	Bearing Frame	P85014	P85014	P85014
35	Shaft	P85017	P85017	P85017
36	Bearing Cap	P85020	P85020	P85020
41	Ball Bearing – Pump End	186002	186002	186002
42	Ball Bearing – Coupler End	186001	186001	186001
27	i-ALERT Condition Monitor	185400	185400	185400
34	Spring Washer	J92558	J92558	J92558
37	Bearing Cap Capscrew (4)	P32000	P32000	P32000
19	Water Slinger	P53550	P53550	P53550
PARTS FOR PUMPS WITH 1 5/8" SHAFT AT SEAL				
2	Impeller (State Diameter) 9 1/2" Full Dia.	P50739	P50739	P50746 [†]
8	Impeller Capscrew	P13800	P13800	P13800
9	Impeller Lockwasher	J23875	J23875	J23875
10	Impeller Washer	P51230	P51230	P46382
20	Impeller Key (Straight) Aug. 1989 (H98) and After	P49372	P49372	P49372
20	Impeller Key (Woodruff) July 1989 (G98) and Before	H32700	H32700	H32700
4	Volute Coverplate	P85039	P85039	P85039
44	Bracket	P85025	P85025	P85025
18	Bearing Frame Assembly Consisting of:	185323	185323	185323
33	Bearing Frame	P85016	P85016	P85016
35	Shaft	P85018	P85018	P85018
36	Bearing Cap	P85065	P85065	P85065
41	Ball Bearing – Pump End	186571	186571	186571
42	Ball Bearing – Coupler End	186572	186572	186572
27	i-ALERT Condition Monitor	185400	185400	185400
34	Spring Washer	J92560	J92560	J92560
37	Bearing Cap Capscrew (4)	DJ0034	DJ0034	DJ0034
19	Water Slinger	P77320	P77320	P77320

*Includes Wear Ring.

■ – Factory recommended spare parts.

[†]Consult factory for delivery.

NOTE: All Bronze Series 1510 Pumps are obsolete.

3BB

ITEM NO.	DESCRIPTION	PUMP CONSTRUCTION		
		BRONZE FITTED	BRONZE FITTED W/WEAR RING	ALL IRON
PARTS COMMON TO BOTH SIZE PUMPS				
1	Volute	P42740 [†]	N/A**	P42740 [†]
	Wear Ring	—	P50590	—
	Volute Drain Plug (4)	P39040	P39040	P39050
5	Volute Capscrew (12)	P03470	P03470	P03470
3	Volute Gasket	P48690	P48690	P48690
17	Coupler Key (Straight) Aug. 1989 (H98) and After	P49373	P49373	P49373
17	Coupler Key (Woodruff) July 1989 (G98) and Before	H32600	H32600	H32600
	Seal or Packing	See Table A, B, C or D, Page 55		
16	Coupler	See Coupler Selection Table, Page 53		
ANSI/OSHA Coupling Guard & Support Bracket Kit Selection, See Page 54				
PARTS FOR PUMPS WITH 1¹/₄" SHAFT AT SEAL				
2	Impeller (State Diameter) 9 ¹ / ₂ " Full Dia.	P49620 [†]	P49620 [†]	P49600 [†]
8	Impeller Capscrew	P52350	P52350	P52350
9	Impeller Lockwasher	J23874	J23874	J23874
10	Impeller Washer	P46380	P46380	P46381
20	Impeller Key (Straight) Aug. 1989 (H98) and After	P49369	P49369	P49369
20	Impeller Key (Woodruff) July 1989 (G98) and Before	H32500	H32500	H32500
4	Volute Coverplate	P85031	P85031	P85031
44	Bracket	P85023	P85023	P85023
18	Bearing Frame Assembly Consisting of:	185321	185321	185321
33	Bearing Frame	P85014	P85014	P85014
35	Shaft	P85017	P85017	P85017
36	Bearing Cap	P85020	P85020	P85020
41	Ball Bearing – Pump End	186002	186002	186002
42	Ball Bearing – Coupler End	186001	186001	186001
27	i-ALERT Condition Monitor	185400	185400	185400
34	Spring Washer	J92558	J92558	J92558
37	Bearing Cap Capscrew (4)	P32000	P32000	P32000
19	Water Slinger	P53550	P53550	P53550
PARTS FOR PUMPS WITH 1⁵/₈" SHAFT AT SEAL				
2	Impeller (State Diameter) 9 ¹ / ₂ " Full Dia.	P49640	P49640	P49660
8	Impeller Capscrew	P13800	P13800	P13800
9	Impeller Lockwasher	J23875	J23875	J23875
10	Impeller Washer	P51230	P51230	P46382
20	Impeller Key (Straight) Aug. 1989 (H98) and After	P49372	P49372	P49372
20	Impeller Key (Woodruff) July 1989 (G98) and Before	H32700	H32700	H32700
4	Volute Coverplate	P85039	P85039	P85039
44	Bracket	P85025	P85025	P85025
18	Bearing Frame Assembly Consisting of:	185323	185323	185323
33	Bearing Frame	P85016	P85016	P85016
35	Shaft	P85018	P85018	P85018
36	Bearing Cap	P85065	P85065	P85065
41	Ball Bearing – Pump End	186571	186571	186571
42	Ball Bearing – Coupler End	186572	186572	186572
27	i-ALERT Condition Monitor	185400	185400	185400
34	Spring Washer	J92560	J92560	J92560
37	Bearing Cap Capscrew (4)	DJ0034	DJ0034	DJ0034
19	Water Slinger	P77320	P77320	P77320

N/A — NO LONGER AVAILABLE

**The impeller and/or volute are no longer available. This pump can be converted to the current style pump by ordering both the current style impeller and current style volute.

■ — Factory recommended spare parts.

[†]Consult factory for delivery.

NOTE: All Bronze Series 1510 Pumps are obsolete.

3BC

ITEM NO.	DESCRIPTION	PUMP CONSTRUCTION		
		BRONZE FITTED	BRONZE FITTED W/WEAR RING	ALL IRON
PARTS COMMON TO BOTH SIZE PUMPS				
1	Volute	P71536	P71537*	P71536
	Wear Ring	—	P50590	—
	Volute Drain Plug (4)	P39040	P39040	P39050
5	Volute Capscrew (12)	P03470	P03470	P03470
3	Volute Gasket	P48690	P48690	P48690
17	Coupler Key (Straight) Aug. 1989 (H98) and After	P49373	P49373	P49373
17	Coupler Key (Woodruff) July 1989 (G98) and Before	H32600	H32600	H32600
	Seal or Packing	See Table A, B, C or D, Page 55		
16	Coupler	See Coupler Selection Table, Page 53		
ANSI/OSHA Coupling Guard & Support Bracket Kit Selection, See Page 54				
PARTS FOR PUMPS WITH 1¹/₄" SHAFT AT SEAL				
2	Impeller (State Diameter) 9 ¹ / ₂ " Full Dia.	P71542	P71542	P71548 [†]
8	Impeller Capscrew	P52350	P52350	P52350
9	Impeller Lockwasher	J23874	J23874	J23874
10	Impeller Washer	P46380	P46380	P46381
20	Impeller Key (Straight) Aug. 1989 (H98) and After	P49369	P49369	P49369
20	Impeller Key (Woodruff) July 1989 (G98) and Before	H32500	H32500	H32500
4	Volute Coverplate	P85031	P85031	P85031
44	Bracket	P85023	P85023	P85023
18	Bearing Frame Assembly Consisting of:	185321	185321	185321
33	Bearing Frame	P85014	P85014	P85014
35	Shaft	P85017	P85017	P85017
36	Bearing Cap	P85020	P85020	P85020
41	Ball Bearing – Pump End	186002	186002	186002
42	Ball Bearing – Coupler End	186001	186001	186001
27	i-ALERT Condition Monitor	185400	185400	185400
34	Spring Washer	J92558	J92558	J92558
37	Bearing Cap Capscrew (4)	P32000	P32000	P32000
19	Water Slinger	P53550	P53550	P53550
PARTS FOR PUMPS WITH 1⁵/₈" SHAFT AT SEAL				
2	Impeller (State Diameter) 9 ¹ / ₂ " Full Dia.	P71545	P71545	P71551 [†]
8	Impeller Capscrew	P13800	P13800	P13800
9	Impeller Lockwasher	J23875	J23875	J23875
10	Impeller Washer	P51230	P51230	P46382
20	Impeller Key (Straight) Aug. 1989 (H98) and After	P49372	P49372	P49372
20	Impeller Key (Woodruff) July 1989 (G98) and Before	H32700	H32700	H32700
4	Volute Coverplate	P85039	P85039	P85039
44	Bracket	P85025	P85025	P85025
18	Bearing Frame Assembly Consisting of:	185323	185323	185323
33	Bearing Frame	P85016	P85016	P85016
35	Shaft	P85018	P85018	P85018
36	Bearing Cap	P85065	P85065	P85065
41	Ball Bearing – Pump End	186571	186571	186571
42	Ball Bearing – Coupler End	186572	186572	186572
27	i-ALERT Condition Monitor	185400	185400	185400
34	Spring Washer	J92560	J92560	J92560
37	Bearing Cap Capscrew (4)	DJ0034	DJ0034	DJ0034
19	Water Slinger	P77320	P77320	P77320

*Includes Wear Ring.

■ – Factory recommended spare parts.

†Consult factory for delivery.

4BB

ITEM NO.	DESCRIPTION	PUMP CONSTRUCTION		
		BRONZE FITTED	BRONZE FITTED W/WEAR RING	ALL IRON
PARTS COMMON TO BOTH SIZE PUMPS				
1	Volute	N/A**	N/A**	N/A**
	Wear Ring	—	N/A	—
	Volute Drain Plug (4)	P39040	P39040	P39050
3	Volute Capscrew (12)	P03470	P03470	P03470
5	Volute Gasket	P48690	P48690	P48690
17	Coupler Key (Straight) Aug. 1989 (H98) and After	P49373	P49373	P49373
17	Coupler Key (Woodruff) July 1989 (G98) and Before	H32600	H32600	H32600
	Seal or Packing	See Table A, B, C or D, Page 55		
16	Coupler	See Coupler Selection Table, Page 53		
ANSI/OSHA Coupling Guard & Support Bracket Kit Selection, See Page 54				
PARTS FOR PUMPS WITH 1¹/₄" SHAFT AT SEAL				
2	Impeller (State Diameter) 9 ¹ / ₂ " Full Dia.	P50550 [†]	P50550 [†]	P50390 [†]
8	Impeller Capscrew	P52350	P52350	P52350
9	Impeller Lockwasher	J23874	J23874	J23874
10	Impeller Washer	P46380	P46380	P46381
20	Impeller Key (Straight) Aug. 1989 (H98) and After	P49369	P49369	P49369
20	Impeller Key (Woodruff) July 1989 (G98) and Before	H32500	H32500	H32500
4	Volute Coverplate	P85031	P85031	P85031
44	Bracket	P85023	P85023	P85023
18	Bearing Frame Assembly Consisting of:	185321	185321	185321
33	Bearing Frame	P85014	P85014	P85014
35	Shaft	P85017	P85017	P84999
36	Bearing Cap	P85020	P85020	P85020
41	Ball Bearing – Pump End	186002	186002	186002
42	Ball Bearing – Coupler End	186001	186001	186001
27	i-ALERT Condition Monitor	185400	185400	185400
34	Spring Washer	J92558	J92558	J92558
37	Bearing Cap Capscrew (4)	P32000	P32000	P32000
19	Water Slinger	P53550	P53550	P53550
PARTS FOR PUMPS WITH 1⁵/₈" SHAFT AT SEAL				
2	Impeller (State Diameter) 9 ¹ / ₂ " Full Dia.	P50570 [†]	P50570 [†]	P50330 [†]
8	Impeller Capscrew	P13800	P13800	P13800
9	Impeller Lockwasher	J23875	J23875	J23875
10	Impeller Washer	P51230	P51230	P46382
20	Impeller Key (Straight) Aug. 1989 (H98) and After	P49372	P49372	P49372
20	Impeller Key (Woodruff) July 1989 (G98) and Before	H32700	H32700	H32700
4	Volute Coverplate	P85039	P85039	P85039
44	Bracket	P85025	P85025	P85025
18	Bearing Frame Assembly Consisting of:	185323	185323	185323
33	Bearing Frame	P85016	P85016	P85016
35	Shaft	P85018	P85018	P85018
36	Bearing Cap	P85065	P85065	P85065
41	Ball Bearing – Pump End	186571	186571	186571
42	Ball Bearing – Coupler End	186572	186572	186572
27	i-ALERT Condition Monitor	185400	185400	185400
34	Spring Washer	J92560	J92560	J92560
37	Bearing Cap Capscrew (4)	DJ0034	DJ0034	DJ0034
19	Water Slinger	P77320	P77320	P77320

N/A — NO LONGER AVAILABLE

**The impeller and/or volute are no longer available. This pump can be converted to the current style pump by ordering both the current style impeller and current style volute.

■ – Factory recommended spare parts.

†Consult factory for delivery.

NOTE: All Bronze Series 1510 Pumps are obsolete.

4BC

ITEM NO.	DESCRIPTION	PUMP CONSTRUCTION		
		BRONZE FITTED	BRONZE FITTED W/WEAR RING	ALL IRON
1	Volute	P43362	P44147*	P43362
	Wear Ring	—	P49142	—
	Volute Drain Plug (4)	P39040	P39040	P39050
5	Volute Capscrew (12)	P03470	P03470	P03470
3	Volute Gasket	P48690	P48690	P48690
17	Coupler Key (Straight) Aug. 1989 (H98) and After	P49373	P49373	P49373
17	Coupler Key (Woodruff) July 1989 (G98) and Before	H32600	H32600	H32600
	Seal or Packing	See Table A, B, C or D, Page 55		
16	Coupler	See Coupler Selection Table, Page 53		
ANSI/OSHA Coupling Guard & Support Bracket Kit Selection, See Page 54				
2	Impeller (State Diameter) 9 ¹ / ₂ " Full Dia.	P50755	P50755	P50759 [†]
8	Impeller Capscrew	P13800	P13800	P13800
9	Impeller Lockwasher	J23875	J23875	J23875
10	Impeller Washer	P51230	P51230	P46382
20	Impeller Key (Straight) Aug. 1989 (H98) and After	P49372	P49372	P49372
	Impeller Key (Woodruff) July 1989 (G98) and Before	H32700	H32700	H32700
4	Volute Coverplate	P85039	P85039	P85039
44	Bracket	P85025	P85025	P85025
18	Bearing Frame Assembly Consisting of:	185323	185323	185323
33	Bearing Frame	P85016	P85016	P85016
35	Shaft	P85018	P85018	P85018
36	Bearing Cap	P85065	P85065	P85065
41	Ball Bearing – Pump End	186571	186571	186571
42	Ball Bearing – Coupler End	186572	186572	186572
27	i-ALERT Condition Monitor	185400	185400	185400
34	Spring Washer	J92560	J92560	J92560
37	Bearing Cap Capscrew (4)	DJ0034	DJ0034	DJ0034
19	Water Slinger	P77320	P77320	P77320

*Includes Wear Ring.

■ – Factory recommended spare parts.

[†]Consult factory for delivery.

5BB

ITEM NO.	DESCRIPTION	PUMP CONSTRUCTION		
		BRONZE FITTED	BRONZE FITTED W/WEAR RING	ALL IRON
PARTS COMMON TO BOTH SIZE PUMPS				
1	Volute	N/A**	N/A**	N/A**
	Wear Ring	—	P50990	—
	Volute Drain Plug (4)	P39040	P39040	P39050
3	Volute Capscrew (12)	P03470	P03470	P03470
5	Volute Gasket	P48690	P48690	P48690
17	Coupler Key (Straight) Aug. 1989 (H98) and After	P49373	P49373	P49373
17	Coupler Key (Woodruff) July 1989 (G98) and Before	H32600	H32600	H32600
	Seal or Packing	See Table A, B, C or D, Page 55		
16	Coupler	See Coupler Selection Table, Page 53		
ANSI/OSHA Coupling Guard & Support Bracket Kit Selection, See Page 54				
PARTS FOR PUMPS WITH 1 1/4" SHAFT AT SEAL				
2	Impeller (State Diameter) 9 1/2" Full Dia.	P50930 [†]	P50930 [†]	N/A**
8	Impeller Capscrew	P52350	P52350	P52350
9	Impeller Lockwasher	J23874	J23874	J23874
10	Impeller Washer	P46380	P46380	P46381
20	Impeller Key (Straight) Aug. 1989 (H98) and After	P49369	P49369	P49369
20	Impeller Key (Woodruff) July 1989 (G98) and Before	H32500	H32500	H32500
4	Volute Coverplate	P85031	P85031	P85031
44	Bracket	P85023	P85023	P85023
18	Bearing Frame Assembly Consisting of:	185321	185321	185321
33	Bearing Frame	P85014	P85014	P85014
35	Shaft	P85017	P85017	P85017
36	Bearing Cap	P85020	P85020	P85020
41	Ball Bearing – Pump End	186002	186002	186002
42	Ball Bearing – Coupler End	186001	186001	186001
27	i-ALERT Condition Monitor	185400	185400	185400
34	Spring Washer	J92558	J92558	J92558
37	Bearing Cap Capscrew (4)	P32000	P32000	P32000
19	Water Slinger	P53550	P53550	P53550
PARTS FOR PUMPS WITH 1 5/8" SHAFT AT SEAL				
2	Impeller (State Diameter) 9 1/2" Full Dia.	P50970 [†]	P50970 [†]	N/A**
8	Impeller Capscrew	P13800	P13800	P13800
9	Impeller Lockwasher	J23875	J23875	J23875
10	Impeller Washer	P51230	P51230	P46382
20	Impeller Key (Straight) Aug. 1989 (H98) and After	P49372	P49372	P49372
20	Impeller Key (Woodruff) July 1989 (G98) and Before	H32700	H32700	H32700
4	Volute Coverplate	P85039	P85039	P85039
44	Bracket	P85025	P85025	P85025
18	Bearing Frame Assembly Consisting of:	185323	185323	185323
33	Bearing Frame	P85016	P85016	P85016
35	Shaft	P85018	P85018	P85018
36	Bearing Cap	P85065	P85065	P85065
41	Ball Bearing – Pump End	186571	186571	186571
42	Ball Bearing – Coupler End	186572	186572	186572
27	i-ALERT Condition Monitor	185400	185400	185400
34	Spring Washer	J92560	J92560	J92560
37	Bearing Cap Capscrew (4)	DJ0034	DJ0034	DJ0034
19	Water Slinger	P77320	P77320	P77320

N/A — NO LONGER AVAILABLE

**The impeller and/or volute are no longer available. This pump can be converted to the current style pump by ordering both the current style impeller and current style volute.

■ — Factory recommended spare parts.

[†]Consult factory for delivery.

NOTE: All Bronze Series 1510 Pumps are obsolete.

5BC

ITEM NO.	DESCRIPTION	PUMP CONSTRUCTION		
		BRONZE FITTED	BRONZE FITTED W/WEAR RING	ALL IRON
1	Volute	P43678	P43863*	P43678
	Wear Ring	—	P49143	—
	Volute Drain Plug (4)	P39040	P39040	P39050
5	Volute Capscrew (12)	P03470	P03470	P03470
3	Volute Gasket	P48690	P48690	P48690
17	Coupler Key (Straight) Aug. 1989 (H98) and After	P49373	P49373	P49373
17	Coupler Key (Woodruff) July 1989 (G98) and Before	H32600	H32600	H32600
	Seal or Packing	See Table A, B, C or D, Page 55		
16	Coupler	See Coupler Selection Table, Page 53		
ANSI/OSHA Coupling Guard & Support Bracket Kit Selection, See Page 54				
2	Impeller (State Diameter) 9 ¹ / ₂ " Full Dia.	P50832	P50832	P50834 [†]
8	Impeller Capscrew	P13800	P13800	P13800
9	Impeller Lockwasher	J23875	J23875	J23875
10	Impeller Washer	P51230	P51230	P46382
20	Impeller Key (Straight) Aug. 1989 (H98) and After	P49372	P49372	P49372
20	Impeller Key (Woodruff) July 1989 (G98) and Before	H32700	H32700	H32700
4	Volute Coverplate	P85039	P85039	P85039
44	Bracket	P85025	P85025	P85025
18	Bearing Frame Assembly Consisting of:	185323	185323	185323
33	Bearing Frame	P85016	P85016	P85016
35	Shaft	P85018	P85018	P85018
36	Bearing Cap	P85065	P85065	P85065
41	Ball Bearing – Pump End	186571	186571	186571
42	Ball Bearing – Coupler End	186572	186572	186572
27	i-ALERT Condition Monitor	185400	185400	185400
34	Spring Washer	J92560	J92560	J92560
37	Bearing Cap Capscrew (4)	DJ0034	DJ0034	DJ0034
19	Water Slinger	P77320	P77320	P77320

*Includes Wear Ring.

■ – Factory recommended spare parts.

[†]Consult factory for delivery.

6BB

ITEM NO.	DESCRIPTION	PUMP CONSTRUCTION		
		BRONZE FITTED	BRONZE FITTED W/WEAR RING	ALL IRON
1	Volute	N/A**	N/A**	N/A**
	Wear Ring	—	P51390	—
	Volute Drain Plug (4)	P39040	P39040	P39050
5	Volute Capscrew (12)	P03470	P03470	P03470
3	Volute Gasket	P48690	P48690	P48690
17	Coupler Key (Straight) Aug. 1989 (H98) and After	P49373	P49373	P49373
17	Coupler Key (Woodruff) July 1989 (G98) and Before	H32600	H32600	H32600
	Seal or Packing	See Table A, B, C or D, Page 55		
16	Coupler	See Coupler Selection Table, Page 53		
ANSI/OSHA Coupling Guard & Support Bracket Kit Selection, See Page 54				
2	Impeller (State Diameter)	N/A**	N/A**	N/A**
8	Impeller Capscrew	P13800	P13800	P13800
9	Impeller Lockwasher	J23875	J23875	J23875
10	Impeller Washer	P51230	P51230	P46382
20	Impeller Key (Straight) Aug. 1989 (H98) and After	P49372	P49372	P49372
20	Impeller Key (Woodruff) July 1989 (G98) and Before	H32700	H32700	H32700
4	Volute Coverplate	P85039	P85039	P85039
44	Bracket	P85025	P85025	P85025
18	Bearing Frame Assembly Consisting of:	185323	185323	185323
33	Bearing Frame	P85016	P85016	P85016
35	Shaft	P85018	P85018	P85018
36	Bearing Cap	P85065	P85065	P85065
41	Ball Bearing – Pump End	186571	186571	186571
42	Ball Bearing – Coupler End	186572	186572	186572
27	i-ALERT Condition Monitor	185400	185400	185400
34	Spring Washer	J92560	J92560	J92560
37	Bearing Cap Capscrew (4)	DJ0034	DJ0034	DJ0034
19	Water Slinger	P77320	P77320	P77320

N/A — NO LONGER AVAILABLE

**The impeller and/or volute are no longer available. This pump can be converted to the current style pump by ordering both the current style impeller and current style volute.

■ — Factory recommended spare parts.

†Consult factory for delivery.

6BC

ITEM NO.	DESCRIPTION	PUMP CONSTRUCTION		
		BRONZE FITTED	BRONZE FITTED W/WEAR RING	ALL IRON
1	Volute	P43692	P43864*	P43692
	Wear Ring	—	P49144	—
	Volute Drain Plug (4)	P39040	P39040	P39050
5	Volute Capscrew (12)	P03470	P03470	P03470
3	Volute Gasket	P48690	P48690	P48690
17	Coupler Key (Straight) Aug. 1989 (H98) and After	P49373	P49373	P49373
17	Coupler Key (Woodruff) July 1986 (G98) and Before	H32600	H32600	H32600
	Seal or Packing	See Table A, B, C or D, Page 55		
16	Coupler	See Coupler Selection Table, Page 53		
ANSI/OSHA Coupling Guard & Support Bracket Kit Selection, See Page 54				
2	Impeller (State Diameter) 9 ¹ / ₂ " Full Dia.	P50842	P50842	P50844 [†]
8	Impeller Capscrew	P13800	P13800	P13800
9	Impeller Lockwasher	J23875	J23875	J23875
10	Impeller Washer	P51230	P51230	P46382
20	Impeller Key (Straight) Aug. 1989 (H98) and After	P49372	P49372	P49372
20	Impeller Key (Woodruff) July 1989 (G98) and Before	H32700	H32700	H32700
4	Volute Coverplate	P85039	P85039	P85039
44	Bracket	P85025	P85025	P85025
18	Bearing Frame Assembly Consisting of:	185323	185323	18532
33	Bearing Frame	P85016	P85016	P85016
35	Shaft	P85018	P85018	P85018
36	Bearing Cap	P85065	P85065	P85065
41	Ball Bearing – Pump End	186571	186571	186571
42	Ball Bearing – Coupler End	186572	186572	186572
27	i-ALERT Condition Monitor	185400	185400	185400
34	Spring Washer	J92560	J92560	J92560
37	Bearing Cap Capscrew (4)	DJ0034	DJ0034	DJ0034
19	Water Slinger	P77320	P77320	P77320

*Includes Wear Ring.

■ – Factory recommended spare parts.

[†]Consult factory for delivery.

2CB

ITEM NO.	DESCRIPTION	PUMP CONSTRUCTION		
		BRONZE FITTED	BRONZE FITTED W/WEAR RING	ALL IRON
1	Volute	N/A**	N/A**	N/A**
	Wear Ring	—	P49130	—
	Volute Drain Plug (4)	P39040	P39040	P39050
5	Volute Capscrew (16)	P13780	P13780	P13780
3	Volute Gasket	P57770	P57770	P57770
17	Coupler Key (Straight) Aug. 1989 (H98) and After	P49373	P49373	P49373
17	Coupler Key (Woodruff) July 1989 (G98) and Before	H32600	H32600	H32600
	Seal or Packing	See Table A, B, C or D, Page 55		
16	Coupler	See Coupler Selection Table, Page 53		
ANSI/OSHA Coupling Guard & Support Bracket Kit Selection, See Page 54				
2	Impeller (State Diameter) 12 ¹ / ₂ " Full Dia.	P77497	P77497	P51414 [†]
8	Impeller Capscrew	P13800	P13800	P13800
9	Impeller Lockwasher	J23875	J23875	J23875
10	Impeller Washer	P51230	P51230	P46382
20	Impeller Key (Straight) Aug. 1989 (H98) and After	P49372	P49372	P49372
20	Impeller Key (Woodruff) July 1989 (G98) and Before	H32700	H32700	H32700
4	Volute Coverplate	P51526	P51526	P51526
44	Bracket	P85025	P85025	P85025
18	Bearing Frame Assembly Consisting of:	185323	185323	185323
33	Bearing Frame	P85016	P85016	P85016
35	Shaft	P85018	P85018	P85018
36	Bearing Cap	P85065	P85065	P85065
41	Ball Bearing – Pump End	186571	186571	186571
42	Ball Bearing – Coupler End	186572	186572	186572
27	i-ALERT Condition Monitor	185400	185400	185400
34	Spring Washer	J92560	J92560	J92560
37	Bearing Cap Capscrew (4)	DJ0034	DJ0034	DJ0034
19	Water Slinger	P77320	P77320	P77320

N/A — NO LONGER AVAILABLE

**If a volute or volute coverplate is required, both must be changed to the appropriate "G" size, along with the "G" size volute gasket.

■ — Factory recommended spare parts.

3CB

ITEM NO.	DESCRIPTION	PUMP CONSTRUCTION		
		BRONZE FITTED	BRONZE FITTED W/WEAR RING	ALL IRON
1	Volute	N/A**	N/A**	N/A**
	Wear Ring	—	P50650	—
	Volute Drain Plug (4)	P39040	P39040	P39050
5	Volute Capscrew (16)	P13780	P13780	P13780
3	Volute Gasket	P57770	P57770	P57770
17	Coupler Key (Straight) Aug. 1989 (H98) and After	P49373	P49373	P49373
17	Coupler Key (Woodruff) July 1989 (G98) and Before	H32600	H32600	H32600
	Seal or Packing	See Table A, B, C or D, Page 55		
16	Coupler	See Coupler Selection Table, Page 53		
ANSI/OSHA Coupling Guard & Support Bracket Kit Selection, See Page 54				
2	Impeller (State Diameter) 12 ¹ / ₂ " Full Dia.	P77501	P77501	P51418 [†]
8	Impeller Capscrew	P13800	P13800	P13800
9	Impeller Lockwasher	J23875	J23875	J23875
10	Impeller Washer	P51230	P51230	P46382
20	Impeller Key (Straight) Aug. 1989 (H98) and After	P49372	P49372	P49372
20	Impeller Key (Woodruff) July 1989 (G98) and Before	H32700	H32700	H32700
4	Volute Coverplate	P51526	P51526	P51526
44	Bracket	P85025	P85025	P85025
18	Bearing Frame Assembly Consisting of:	185323	185323	185323
33	Bearing Frame	P85016	P85016	P85016
35	Shaft	P85018	P85018	P85018
36	Bearing Cap	P85065	P85065	P85065
41	Ball Bearing – Pump End	186571	186571	186571
42	Ball Bearing – Coupler End	186572	186572	186572
27	i-ALERT Condition Monitor	185400	185400	185400
34	Spring Washer	J92560	J92560	J92560
37	Bearing Cap Capscrew (4)	DJ0034	DJ0034	DJ0034
19	Water Slinger	P77320	P77320	P77320
12	Support Foot – Motor Frames 213T-215T, 254T-256T, 284T	186907	186907	186907

N/A — NO LONGER AVAILABLE

**If a volute or volute coverplate is required, both must be changed to the appropriate "G" size, along with the "G" size volute gasket.

— Factory recommended spare parts.

[†]Consult factory for delivery.

4CB

ITEM NO.	DESCRIPTION	PUMP CONSTRUCTION		
		BRONZE FITTED	BRONZE FITTED W/WEAR RING	ALL IRON
1	Volute	N/A**	N/A**	N/A**
	Wear Ring	—	P49134	—
	Volute Drain Plug (4)	P39040	P39040	P39050
5	Volute Capscrew (16)	P13780	P13780	P13780
3	Volute Gasket	P57770	P57770	P57770
17	Coupler Key (Straight) Aug. 1989 (H98) and After	P49373	P49373	P49373
17	Coupler Key (Woodruff) July 1989 (G98) and Before	H32600	H32600	H32600
	Seal or Packing	See Table A, B, C or D, Page 55		
16	Coupler	See Coupler Selection Table, Page 53		
	ANSI/OSHA Coupling Guard & Support Bracket Kit Selection, See Page 54			
2	Impeller (State Diameter) 12 ¹ / ₂ " Full Dia.	P77505	P77505	P51424 [†]
8	Impeller Capscrew	P13800	P13800	P13800
9	Impeller Lockwasher	J23875	J23875	J23875
10	Impeller Washer	P51230	P51230	P46382
20	Impeller Key (Straight) Aug. 1989 (H98) and After	P49372	P49372	P49372
20	Impeller Key (Woodruff) July 1989 (G98) and Before	H32700	H32700	H32700
4	Volute Coverplate	P51526	P51526	P51526
44	Bracket	P85025	P85025	P85025
18	Bearing Frame Assembly Consisting of:	185323	185323	185323
33	Bearing Frame	P85016	P85016	P85016
35	Shaft	P85018	P85018	P85018
36	Bearing Cap	P85065	P85065	P85065
41	Ball Bearing – Pump End	186571	186571	186571
42	Ball Bearing – Coupler End	186572	186572	186572
27	i-ALERT Condition Monitor	185400	185400	185400
34	Spring Washer	J92560	J92560	J92560
37	Bearing Cap Capscrew (4)	DJ0034	DJ0034	DJ0034
19	Water Slinger	P77320	P77320	P77320

N/A — NO LONGER AVAILABLE

**If a volute or volute coverplate is required, both must be changed to the appropriate "G" size, along with the "G" size volute gasket.

 – Factory recommended spare parts.

5CB

ITEM NO.	DESCRIPTION	PUMP CONSTRUCTION		
		BRONZE FITTED	BRONZE FITTED W/WEAR RING	ALL IRON
1	Volute	N/A**	N/A**	N/A**
	Wear Ring	—	P49136	—
	Volute Drain Plug (4)	P39040	P39040	P39050
5	Volute Capscrew (16)	P13780	P13780	P13780
3	Volute Gasket	P57770	P57770	P57770
17	Coupler Key (Straight) Aug. 1989 (H98) and After	P49373	P49373	P49373
17	Coupler Key (Woodruff) July 1989 (G98) and Before	H32600	H32600	H32600
	Seal or Packing	See Table A, B, C or D, Page 55		
16	Coupler	See Coupler Selection Table, Page 53		
ANSI/OSHA Coupling Guard & Support Bracket Kit Selection, See Page 54				
2	Impeller (State Diameter) 12 ¹ / ₂ " Full Dia.	P77509	P77509	N/A
8	Impeller Capscrew	P13800	P13800	P13800
9	Impeller Lockwasher	J23875	J23875	J23875
10	Impeller Washer	P51230	P51230	P46382
20	Impeller Key (Straight) Aug. 1989 (H98) and After	P49372	P49372	P49372
20	Impeller Key (Woodruff) July 1989 (G98) and Before	H32700	H32700	H32700
4	Volute Coverplate	P51526	P51526	P51526
44	Bracket	P85025	P85025	P85025
18	Bearing Frame Assembly Consisting of:	185323	185323	185323
33	Bearing Frame	P85016	P85016	P85016
35	Shaft	P85018	P85018	P85018
36	Bearing Cap	P85065	P85065	P85065
41	Ball Bearing – Pump End	186571	186571	186571
42	Ball Bearing – Coupler End	186572	186572	186572
27	i-ALERT Condition Monitor	185400	185400	185400
34	Spring Washer	J92560	J92560	J92560
37	Bearing Cap Capscrew (4)	DJ0034	DJ0034	DJ0034
19	Water Slinger	P77320	P77320	P77320

N/A — NO LONGER AVAILABLE

**If a volute or volute coverplate is required, both must be changed to the appropriate "G" size, along with the "G" size volute gasket.

■ — Factory recommended spare parts.

6CB

ITEM NO.	DESCRIPTION	PUMP CONSTRUCTION		
		BRONZE FITTED	BRONZE FITTED W/WEAR RING	ALL IRON
1	Volute	N/A**	N/A**	N/A**
	Wear Ring	—	P49138	—
	Volute Drain Plug (4)	P39040	P39040	P39050
5	Volute Capscrew (16)	P13780	P13780	P13780
3	Volute Gasket	P57770	P57770	P57770
17	Coupler Key (Straight) Aug. 1989 (H98) and After	P49373	P49373	P49373
17	Coupler Key (Woodruff) July 1989 (G98) and Before	H32600	H32600	H32600
	Seal or Packing	See Table A, B, C or D, Page 55		
16	Coupler	See Coupler Selection Table, Page 53		
ANSI/OSHA Coupling Guard & Support Bracket Kit Selection, See Page 54				
2	Impeller (State Diameter) 12 ¹ / ₂ " Full Dia.	P77513	P77513	N/A
8	Impeller Capscrew	P13800	P13800	P13800
9	Impeller Lockwasher	J23875	J23875	J23875
10	Impeller Washer	P51230	P51230	P46382
20	Impeller Key (Straight) Aug. 1989 (H98) and After	P49372	P49372	P49372
20	Impeller Key (Woodruff) July 1989 (G98) and Before	H32700	H32700	H32700
4	Volute Coverplate	P51526	P51526	P51526
44	Bracket	P85025	P85025	P85025
18	Bearing Frame Assembly Consisting of:	185323	185323	185323
33	Bearing Frame	P85016	P85016	P85016
35	Shaft	P85018	P85018	P85018
36	Bearing Cap	P85065	P85065	P85065
41	Ball Bearing – Pump End	186571	186571	186571
42	Ball Bearing – Coupler End	186572	186572	186572
27	i-ALERT Condition Monitor	185400	185400	185400
34	Spring Washer	J92560	J92560	J92560
37	Bearing Cap Capscrew (4)	DJ0034	DJ0034	DJ0034
19	Water Slinger	P77320	P77320	P77320

N/A — NO LONGER AVAILABLE

**If a volute or volute coverplate is required, both must be changed to the appropriate "G" size, along with the "G" size volute gasket.

 – Factory recommended spare parts.

2E

ITEM NO.	DESCRIPTION	PUMP CONSTRUCTION		
		BRONZE FITTED	BRONZE FITTED W/WEAR RING	ALL IRON
PARTS COMMON TO BOTH SIZE PUMPS				
1	Volute	P43955	P44019*	P43955
	Wear Ring	—	P49870	—
	Volute Drain Plug (4)	P39040	P39040	P39050
5	Volute Capscrew (16)	P13780	P13780	P13780
3	Volute Gasket	P80765	P80765	P80765
17	Coupler Key (Straight) Aug. 1989 (H98) and After	P49373	P49373	P49373
17	Coupler Key (Woodruff) July 1989 (G98) and Before	H32600	H32600	H32600
	Seal or Packing	See Table A, B, C or D, Page 55		
16	Coupler	See Coupler Selection Table, Page 53		
ANSI/OSHA Coupling Guard & Support Bracket Kit Selection, See Page 54				
PARTS FOR PUMPS WITH 1 1/4" SHAFT AT SEAL				
2	Impeller (State Diameter) 11" Full Dia.	P50848	P50848	P50850†
8	Impeller Capscrew	P52350	P52350	P52350
9	Impeller Lockwasher	J23874	J23874	J23874
10	Impeller Washer	P46380	P46380	P46381
20	Impeller Key (Straight) Aug. 1989 (H98) and After	P49369	P49369	P49369
20	Impeller Key (Woodruff) July 1989 (G98) and Before	H32500	H32500	H32500
4	Volute Coverplate	P53052	P53052	P53052
44	Bracket	P85023	P85023	P85023
18	Bearing Frame Assembly Consisting of:	185321	185321	185321
33	Bearing Frame	P85014	P85014	P85014
35	Shaft	P85017	P85017	P85017
36	Bearing Cap	P85020	P85020	P85020
41	Ball Bearing – Pump End	186002	186002	186002
42	Ball Bearing – Coupler End	186001	186001	186001
27	i-ALERT Condition Monitor	185400	185400	185400
34	Spring Washer	J92558	J92558	J92558
37	Bearing Cap Capscrew (4)	P32000	P32000	P32000
19	Water Slinger	P53550	P53550	P53550
PARTS FOR PUMPS WITH 1 5/8" SHAFT AT SEAL				
2	Impeller (State Diameter) 11" Full Dia.	P50880	P50880	P50882†
8	Impeller Capscrew	P13800	P13800	P13800
9	Impeller Lockwasher	J23875	J23875	J23875
10	Impeller Washer	P51230	P51230	P46382
20	Impeller Key (Straight) Aug. 1989 (H98) and After	P49372	P49372	P49372
20	Impeller Key (Woodruff) July 1989 (G98) and Before	H32700	H32700	H32700
4	Volute Coverplate	P53056	P53056	P53056
44	Bracket	P85025	P85025	P85025
18	Bearing Frame Assembly Consisting of:	185323	185323	185323
33	Bearing Frame	P85016	P85016	P85016
35	Shaft	P85018	P85018	P85018
36	Bearing Cap	P85065	P85065	P85065
41	Ball Bearing – Pump End	186571	186571	186571
42	Ball Bearing – Coupler End	186572	186572	186572
27	i-ALERT Condition Monitor	185400	185400	185400
34	Spring Washer	J92560	J92560	J92560
37	Bearing Cap Capscrew (4)	DJ0034	DJ0034	DJ0034
19	Water Slinger	P77320	P77320	P77320

*Includes Wear Ring.

■ – Factory recommended spare parts.

†Consult factory for delivery.

3E

ITEM NO.	DESCRIPTION	PUMP CONSTRUCTION		
		BRONZE FITTED	BRONZE FITTED W/WEAR RING	ALL IRON
PARTS COMMON TO BOTH SIZE PUMPS				
1	Volute	P43952	P44011*	P43952
	Wear Ring	—	P50650	—
	Volute Drain Plug (4)	P39040	P39040	P39050
5	Volute Capscrew (16)	P13780	P13780	P13780
3	Volute Gasket	P80765	P80765	P80765
17	Coupler Key (Straight) Aug. 1989 (H98) and After	P49373	P49373	P49373
17	Coupler Key (Woodruff) July 1989 (G98) and Before	H32600	H32600	H32600
	Seal or Packing	See Table A, B, C or D, Page 55		
16	Coupler	See Coupler Selection Table, Page 53		
ANSI/OSHA Coupling Guard & Support Bracket Kit Selection, See Page 54				
PARTS FOR PUMPS WITH 1 1/4" SHAFT AT SEAL				
2	Impeller (State Diameter) 11" Full Dia.	P50852	P50852	P50854†
8	Impeller Capscrew	P52350	P52350	P52350
9	Impeller Lockwasher	J23874	J23874	J23874
10	Impeller Washer	P46380	P46380	P46381
20	Impeller Key (Straight) Aug. 1989 (H98) and After	P49369	P49369	P49369
20	Impeller Key (Woodruff) July 1989 (G98) and Before	H32500	H32500	H32500
4	Volute Coverplate	P53052	P53052	P53052
44	Bracket	P85023	P85023	P85023
18	Bearing Frame Assembly Consisting of:	185321	185321	185321
33	Bearing Frame	P85014	P85014	P85014
35	Shaft	P85017	P85017	P85017
36	Bearing Cap	P85020	P85020	P85020
41	Ball Bearing – Pump End	186002	186002	186002
42	Ball Bearing – Coupler End	186001	186001	186001
27	i-ALERT Condition Monitor	185400	185400	185400
34	Spring Washer	J92558	J92558	J92558
37	Bearing Cap Capscrew (4)	P32000	P32000	P32000
19	Water Slinger	P53550	P53550	P53550
PARTS FOR PUMPS WITH 1 5/8" SHAFT AT SEAL				
2	Impeller (State Diameter) 11" Full Dia.	P50856	P50856	P50858†
8	Impeller Capscrew	P13800	P13800	P13800
9	Impeller Lockwasher	J23875	J23875	J23875
10	Impeller Washer	P51230	P51230	P46382
20	Impeller Key (Straight) Aug. 1989 (H98) and After	P49372	P49372	P49372
20	Impeller Key (Woodruff) July 1989 (G98) and Before	H32700	H32700	H32700
4	Volute Coverplate	P53056	P53056	P53056
44	Bracket	P85025	P85025	P85025
18	Bearing Frame Assembly Consisting of:	185323	185323	185323
33	Bearing Frame	P85016	P85016	P85016
35	Shaft	P85018	P85018	P85018
36	Bearing Cap	P85065	P85065	P85065
41	Ball Bearing – Pump End	186571	186571	186571
42	Ball Bearing – Coupler End	186572	186572	186572
27	i-ALERT Condition Monitor	185400	185400	185400
34	Spring Washer	J92560	J92560	J92560
37	Bearing Cap Capscrew (4)	DJ0034	DJ0034	DJ0034
19	Water Slinger	P77320	P77320	P77320

*Includes Wear Ring.

■ – Factory recommended spare parts.

†Consult factory for delivery.

4E

ITEM NO.	DESCRIPTION	PUMP CONSTRUCTION		
		BRONZE FITTED	BRONZE FITTED W/WEAR RING	ALL IRON
PARTS COMMON TO BOTH SIZE PUMPS				
1	Volute	P43958	P44012*	P43958
	Wear Ring	—	P49142	—
	Volute Drain Plug (4)	P39040	P39040	P39050
5	Volute Capscrew (16)	P13780	P13780	P13780
3	Volute Gasket	P80765	P80765	P80765
17	Coupler Key (Straight) Aug. 1989 (H98) and After	P49373	P49373	P49373
17	Coupler Key (Woodruff) July 1989 (G98) and Before	H32600	H32600	H32600
	Seal or Packing	See Table A, B, C or D, Page 55		
16	Coupler	See Coupler Selection Table, Page 53		
ANSI/OSHA Coupling Guard & Support Bracket Kit Selection, See Page 54				
PARTS FOR PUMPS WITH 1 1/4" SHAFT AT SEAL				
2	Impeller (State Diameter) 11" Full Dia.	P50862	P50862	P50864†
8	Impeller Capscrew	P52350	P52350	P52350
9	Impeller Lockwasher	J23874	J23874	J23874
10	Impeller Washer	P46380	P46380	P46381
20	Impeller Key (Straight) Aug. 1989 (H98) and After	P49369	P49369	P49369
20	Impeller Key (Woodruff) July 1989 (G98) and Before	H32500	H32500	H32500
4	Volute Coverplate	P53052	P53052	P53052
44	Bracket	P85023	P85023	P85023
18	Bearing Frame Assembly Consisting of:	185321	185321	185321
33	Bearing Frame	P85014	P85014	P85014
35	Shaft	P85017	P85017	P85017
36	Bearing Cap	P85020	P85020	P85020
41	Ball Bearing – Pump End	186002	186002	186002
42	Ball Bearing – Coupler End	186001	186001	186001
27	i-ALERT Condition Monitor	185400	185400	185400
34	Spring Washer	J92558	J92558	J92558
37	Bearing Cap Capscrew (4)	P32000	P32000	P32000
19	Water Slinger	P53550	P53550	P53550
PARTS FOR PUMPS WITH 1 5/8" SHAFT AT SEAL				
2	Impeller (State Diameter) 11" Full Dia.	P50866	P50866	P50868†
8	Impeller Capscrew	P13800	P13800	P13800
9	Impeller Lockwasher	J23875	J23875	J23875
10	Impeller Washer	P51230	P51230	P46382
20	Impeller Key (Straight) Aug. 1989 (H98) and After	P49372	P49372	P49372
20	Impeller Key (Woodruff) July 1989 (G98) and Before	H32700	H32700	H32700
4	Volute Coverplate	P53056	P53056	P53056
44	Bracket	P85025	P85025	P85025
18	Bearing Frame Assembly Consisting of:	185323	185323	185323
33	Bearing Frame	P85016	P85016	P85016
35	Shaft	P85018	P85018	P85018
36	Bearing Cap	P85065	P85065	P85065
41	Ball Bearing – Pump End	186571	186571	186571
42	Ball Bearing – Coupler End	186572	186572	186572
27	i-ALERT Condition Monitor	185400	185400	185400
34	Spring Washer	J92560	J92560	J92560
37	Bearing Cap Capscrew (4)	DJ0034	DJ0034	DJ0034
19	Water Slinger	P77320	P77320	P77320

*Includes Wear Ring.

■ – Factory recommended spare parts.

†Consult factory for delivery.

5E

ITEM NO.	DESCRIPTION	PUMP CONSTRUCTION		
		BRONZE FITTED	BRONZE FITTED W/WEAR RING	ALL IRON
1	Volute	P43965	P44013*	P43965
	Wear Ring	—	P51390	—
	Volute Drain Plug (4)	P39040	P39040	P39050
5	Volute Capscrew (16)	P13780	P13780	P13780
3	Volute Gasket	P80765	P80765	P80765
17	Coupler Key (Straight) Aug. 1989 (H98) and After	P49373	P49373	P49373
17	Coupler Key (Woodruff) July 1989 (G98) and Before	H32600	H32600	H32600
	Seal or Packing	See Table A, B, C or D, Page 55		
16	Coupler	See Coupler Selection Table, Page 53		
ANSI/OSHA Coupling Guard & Support Bracket Kit Selection, See Page 54				
2	Impeller (State Diameter) 11" Full Dia.	P50872	P50872	P50874 [†]
8	Impeller Capscrew	P13800	P13800	P13800
9	Impeller Lockwasher	J23875	J23875	J23875
10	Impeller Washer	P51230	P51230	P46382
20	Impeller Key (Straight) Aug. 1989 (H98) and After	P49372	P49372	P49372
20	Impeller Key (Woodruff) July 1989 (G98) and Before	H32700	H32700	H32700
4	Volute Coverplate	P53056	P53056	P53056
44	Bracket	P85025	P85025	P85025
18	Bearing Frame Assembly Consisting of:	185323	185323	185323
33	Bearing Frame	P85016	P85016	P85016
35	Shaft	P85018	P85018	P85018
36	Bearing Cap	P85065	P85065	P85065
41	Ball Bearing – Pump End	186571	186571	186571
42	Ball Bearing – Coupler End	186572	186572	186572
27	i-ALERT Condition Monitor	185400	185400	185400
34	Spring Washer	J92560	J92560	J92560
37	Bearing Cap Capscrew (4)	DJ0034	DJ0034	DJ0034
19	Water Slinger	P77320	P77320	P77320

*Includes Wear Ring.

■ – Factory recommended spare parts.

[†]Consult factory for delivery.

6E

ITEM NO.	DESCRIPTION	PUMP CONSTRUCTION		
		BRONZE FITTED	BRONZE FITTED W/WEAR RING	ALL IRON
1	Volute	P43972	P44014*	P43972
	Wear Ring	—	P81949	—
	Volute Drain Plug (4)	P39040	P39040	P39050
5	Volute Capscrew (16)	P13780	P13780	P13780
3	Volute Gasket	P80765	P80765	P80765
17	Coupler Key (Straight) Aug. 1989 (H98) and After	P49373	P49373	P49373
17	Coupler Key (Woodruff) July 1989 (G98) and Before	H32600	H32600	H32600
	Seal or Packing	See Table A, B, C or D, Page 55		
16	Coupler	See Coupler Selection Table, Page 53		
ANSI/OSHA Coupling Guard & Support Bracket Kit Selection, See Page 54				
2	Impeller (State Diameter) 11" Full Dia.	P50876	P50876	P50878†
8	Impeller Capscrew	P13800	P13800	P13800
9	Impeller Lockwasher	J23875	J23875	J23875
10	Impeller Washer	P51230	P51230	P46382
20	Impeller Key (Straight) Aug. 1989 (H98) and After	P49372	P49372	P49372
20	Impeller Key (Woodruff) July 1989 (G98) and Before	H32700	H32700	H32700
4	Volute Coverplate	P53056	P53056	P53056
44	Bracket	P85025	P85025	P85025
18	Bearing Frame Assembly Consisting of:	185323	185323	185323
33	Bearing Frame	P85016	P85016	P85016
35	Shaft	P85018	P85018	P85018
36	Bearing Cap	P85065	P85065	P85065
41	Ball Bearing – Pump End	186571	186571	186571
42	Ball Bearing – Coupler End	186572	186572	186572
27	i-ALERT Condition Monitor	185400	185400	185400
34	Spring Washer	J92560	J92560	J92560
37	Bearing Cap Capscrew (4)	DJ0034	DJ0034	DJ0034
19	Water Slinger	P77320	P77320	P77320

*Includes Wear Ring.

■ – Factory recommended spare parts.

†Consult factory for delivery.

2G

ITEM NO.	DESCRIPTION	PUMP CONSTRUCTION		
		BRONZE FITTED	BRONZE FITTED W/WEAR RING	ALL IRON
1	Volute	P44071	P44091*	P44071
	Wear Ring	—	P49130	—
	Volute Drain Plug (4)	P39040	P39040	P39050
5	Volute Capscrew (16)	P13780	P13780	P13780
3	Volute Gasket	P80767	P80767	P80767
17	Coupler Key (Straight) Aug. 1989 (H98) and After	P49373	P49373	P49373
17	Coupler Key (Woodruff) July 1989 (G98) and Before	H32600	H32600	H32600
	Seal or Packing	See Table A, B, C or D, Page 55		
16	Coupler	See Coupler Selection Table, Page 53		
ANSI/OSHA Coupling Guard & Support Bracket Kit Selection, See Page 54				
2	Impeller (State Diameter) 13 ¹ / ₂ " Full Dia.	P51412	P51412	P51414 [†]
8	Impeller Capscrew	P13800	P13800	P13800
9	Impeller Lockwasher	J23875	J23875	J23875
10	Impeller Washer	P51230	P51230	P46382
20	Impeller Key (Straight) Aug. 1989 (H98) and After	P49372	P49372	P49372
20	Impeller Key (Woodruff) July 1989 (G98) and Before	H32700	H32700	H32700
4	Volute Coverplate	P51562	P51562	P51562
44	Bracket	P85025	P85025	P85025
18	Bearing Frame Assembly Consisting of:	185323	185323	185323
33	Bearing Frame	P85016	P85016	P85016
35	Shaft	P85018	P85018	P85018
36	Bearing Cap	P85065	P85065	P85065
41	Ball Bearing – Pump End	186571	186571	186571
42	Ball Bearing – Coupler End	186572	186572	186572
27	i-ALERT Condition Monitor	185400	185400	185400
34	Spring Washer	J92560	J92560	J92560
37	Bearing Cap Capscrew (4)	DJ0034	DJ0034	DJ0034
19	Water Slinger	P77320	P77320	P77320

*Includes Wear Ring.

■ – Factory recommended spare parts.

†Consult factory for delivery.

3G

ITEM NO.	DESCRIPTION	PUMP CONSTRUCTION		
		BRONZE FITTED	BRONZE FITTED W/WEAR RING	ALL IRON
1	Volute	P44073	P44092*	P44073
	Wear Ring	—	P50650	—
	Volute Drain Plug (4)	P39040	P39040	P39050
5	Volute Capscrew (16)	P13780	P13780	P13780
3	Volute Gasket	P80767	P80767	P80767
17	Coupler Key (Straight) Aug. 1989 (H98) and After	P49373	P49373	P49373
17	Coupler Key (Woodruff) July 1989 (G98) and Before	H32600	H32600	H32600
	Seal or Packing	See Table A, B, C or D, Page 55		
16	Coupler	See Coupler Selection Table, Page 53		
ANSI/OSHA Coupling Guard & Support Bracket Kit Selection, See Page 54				
2	Impeller (State Diameter) 13 ¹ / ₂ " Full Dia.	P51416	P51416	P51418 [†]
8	Impeller Capscrew	P13800	P13800	P13800
9	Impeller Lockwasher	J23875	J23875	J23875
10	Impeller Washer	P51230	P51230	P46382
20	Impeller Key (Straight) Aug. 1989 (H98) and After	P49372	P49372	P49372
20	Impeller Key (Woodruff) July 1989 (G98) and Before	H32700	H32700	H32700
4	Volute Coverplate	P51562	P51562	P51562
44	Bracket	P85025	P85025	P85025
18	Bearing Frame Assembly Consisting of:	185323	185323	185323
33	Bearing Frame	P85016	P85016	P85016
35	Shaft	P85018	P85018	P85018
36	Bearing Cap	P85065	P85065	P85065
41	Ball Bearing – Pump End	186571	186571	186571
42	Ball Bearing – Coupler End	186572	186572	186572
27	i-ALERT Condition Monitor	185400	185400	185400
34	Spring Washer	J92560	J92560	J92560
37	Bearing Cap Capscrew (4)	DJ0034	DJ0034	DJ0034
19	Water Slinger	P77320	P77320	P77320

*Includes Wear Ring.

■ – Factory recommended spare parts.

[†]Consult factory for delivery.

4G

ITEM NO.	DESCRIPTION	PUMP CONSTRUCTION		
		BRONZE FITTED	BRONZE FITTED W/WEAR RING	ALL IRON
1	Volute	P44075	N/A**	P44075
	Wear Ring	—	P49134	—
	Volute Drain Plug (4)	P39040	P39040	P39050
5	Volute Capscrew (16)	P13780	P13780	P13780
3	Volute Gasket	P80767	P80767	P80767
17	Coupler Key (Straight) Aug. 1989 (H98) and After	P49373	P49373	P49373
17	Coupler Key (Woodruff) July 1989 (G98) and Before	H32600	H32600	H32600
	Seal or Packing	See Table A, B, C or D, Page 55		
16	Coupler	See Coupler Selection Table, Page 53		
ANSI/OSHA Coupling Guard & Support Bracket Kit Selection, See Page 54				
2	Impeller (State Diameter) 13 ¹ / ₂ " Full Dia.	P51422	P51422	P51424 ¹
8	Impeller Capscrew	P13800	P13800	P13800
9	Impeller Lockwasher	J23875	J23875	J23875
10	Impeller Washer	P51230	P51230	P46382
20	Impeller Key (Straight) Aug. 1989 (H98) and After	P49372	P49372	P49372
20	Impeller Key (Woodruff) July 1989 (G98) and Before	H32700	H32700	H32700
4	Volute Coverplate	P51562	P51562	P51562
44	Bracket	P85025	P85025	P85025
18	Bearing Frame Assembly Consisting of:	185323	185323	185323
33	Bearing Frame	P85016	P85016	P85016
35	Shaft	P85018	P85018	P85018
36	Bearing Cap	P85065	P85065	P85065
41	Ball Bearing – Pump End	186571	186571	186571
42	Ball Bearing – Coupler End	186572	186572	186572
27	i-ALERT Condition Monitor	185400	185400	185400
34	Spring Washer	J92560	J92560	J92560
37	Bearing Cap Capscrew (4)	DJ0034	DJ0034	DJ0034
19	Water Slinger	P77320	P77320	P77320

■ – Factory recommended spare parts.

**The impeller and/or volute are no longer available. This pump can be converted to the current style pump by ordering both the current style impeller and current style volute.

4GB

ITEM NO.	DESCRIPTION	PUMP CONSTRUCTION		
		BRONZE FITTED	BRONZE FITTED W/WEAR RING	ALL IRON
1	Volute	P85684	P85685*	P85684
	Wear Ring	—	P49134	—
	Volute Drain Plug (4)	P39040	P39040	P39050
5	Volute Capscrew (16)	P13780	P13780	P13780
3	Volute Gasket	P80767	P80767	P80767
17	Coupler Key (Straight) Aug. 1989 (H98) and After	P49373	P49373	P49373
17	Coupler Key (Woodruff) July 1989 (G98) and Before	H32600	H32600	H32600
	Seal or Packing	See Table A, B, C or D, Page 55		
16	Coupler	See Coupler Selection Table, Page 53		
ANSI/OSHA Coupling Guard & Support Bracket Kit Selection, See Page 54				
2	Impeller (State Diameter) 13 ¹ / ₂ " Full Dia.	P85691	P85691	P85689 [†]
8	Impeller Capscrew	P13800	P13800	P13800
9	Impeller Lockwasher	J23875	J23875	J23875
10	Impeller Washer	P51230	P51230	P46382
20	Impeller Key (Straight) Aug. 1989 (H98) and After	P49372	P49372	P49372
20	Impeller Key (Woodruff) July 1989 (G98) and Before	H32700	H32700	H32700
4	Volute Coverplate	P51562	P51562	P51562
44	Bracket	P85025	P85025	P85025
18	Bearing Frame Assembly Consisting of:	185323	185323	185323
33	Bearing Frame	P85016	P85016	P85016
35	Shaft	P85018	P85018	P85018
36	Bearing Cap	P85065	P85065	P85065
41	Ball Bearing – Pump End	186571	186571	186571
42	Ball Bearing – Coupler End	186572	186572	186572
27	i-ALERT Condition Monitor	185400	185400	185400
34	Spring Washer	J92560	J92560	J92560
37	Bearing Cap Capscrew (4)	DJ0034	DJ0034	DJ0034
19	Water Slinger	P77320	P77320	P77320

*Includes Wear Ring.

■ – Factory recommended spare parts.

†Consult factory for delivery.

5G

ITEM NO.	DESCRIPTION	PUMP CONSTRUCTION		
		BRONZE FITTED	BRONZE FITTED W/WEAR RING	ALL IRON
PARTS COMMON TO BOTH SIZE PUMPS				
1	Volute	P44077	P44094*	P44077
	Wear Ring	—	P49136	—
	Volute Drain Plug (4)	P39040	P39040	P39050
5	Volute Capscrew (16)	P13780	P13780	P13780
3	Volute Gasket	P80767	P80767	P80767
	Seal or Packing	See Table A, B, C or D, Page 55		
16	Coupler	See Coupler Selection Table, Page 53		
ANSI/OSHA Coupling Guard & Support Bracket Kit Selection, See Page 54				
PARTS FOR PUMPS WITH 1⁵/₈" SHAFT AT SEAL				
2	Impeller (State Diameter) 12 ⁹ / ₁₆ " - 13 ¹ / ₂ "	P78533	P78533	P77528
2	Impeller (State Diameter) 12 ¹ / ₂ " Full Dia.	P77509	P77509	P77528
8	Impeller Capscrew	P13800	P13800	P13800
9	Impeller Lockwasher	J23875	J23875	J23875
10	Impeller Washer	P51230	P51230	P46382
20	Impeller Key (Straight) Aug. 1989 (H98) and After	P49372	P49372	P49372
20	Impeller Key (Woodruff) July 1989 (G98) and Before	H32700	H32700	H32700
17	Coupler Key (Straight) Aug. 1989 (H98) and After	P49373	P49373	P49373
17	Coupler Key (Woodruff) July 1989 (G98) and Before	H32600	H32600	H32600
4	Volute Coverplate	P51562	P51562	P51562
44	Bracket	P85025	P85025	P85025
18	Bearing Frame Assembly Consisting of:	185323	185323	185323
33	Bearing Frame	P85016	P85016	P85016
35	Shaft	P85018	P85018	P85018
36	Bearing Cap	P85065	P85065	P85065
41	Ball Bearing – Pump End	186571	186571	186571
42	Ball Bearing – Coupler End	186572	186572	186572
27	i-ALERT Condition Monitor	185400	185400	185400
34	Spring Washer	J92560	J92560	J92560
37	Bearing Cap Capscrew (4)	DJ0034	DJ0034	DJ0034
19	Water Slinger	P77320	P77320	P77320
PARTS FOR PUMPS WITH 2³/₈" SHAFT AT SEAL^Δ				
2	Impeller (State Diameter) 13 ¹ / ₂ " Full Dia.	P51426	P51426	P51428 [†]
8	Impeller Capscrew	J92019	J92019	J92019
9	Impeller Lockwasher	J23876	J23876	J23876
10	Impeller Washer	P46384	P46384	P46385
20	Impeller Key	J93448	J93448	J93448
17	Coupler Key	J93448	J93448	J93448
4	Volute Coverplate	P51566	P51566	P51566
44	Bracket	P51576	P51576	P51576
18	Bearing Frame Assembly Consisting of:	P51705	P51705	P51705
33	Bearing Frame	P51572	P51572	P51572
35	Shaft	P79012	P79012	P79012
36	Bearing Cap – Pump End	P51582	P51582	P51582
	Bearing Cap – Coupler End	P51584	P51584	P51584
41	Ball Bearing – Pump End	J92413	J92413	J92413
42	Ball Bearing – Coupler End	J92414	J92414	J92414
27	i-ALERT Condition Monitor	185400	185400	185400
	Bearing Retainer Ring	J92385	J92385	J92385
	Bearing Locknut	J92388	J92388	J92388
	Bearing Lockwasher	J92389	J92389	J92389
37	Bearing Cap Capscrew (8)	DJ0071	DJ0071	DJ0071
19	Water Slinger	P81917	P81917	P81917

*Includes Wear Ring.

■ – Factory recommended spare parts.

†Consult factory for delivery.

ΔExtra Large Bearing Frame not used on current production pumps, only pumps prior to date code D69.

6G

ITEM NO.	DESCRIPTION	PUMP CONSTRUCTION		
		BRONZE FITTED	BRONZE FITTED W/WEAR RING	ALL IRON
PARTS COMMON TO BOTH SIZE PUMPS				
1	Volute	P44081	P44095*	P44081
	Wear Ring	—	P49138	—
	Volute Drain Plug (4)	P39040	P39040	P39050
5	Volute Capscrew (16)	P13780	P13780	P13780
3	Volute Gasket	P80767	P80767	P80767
	Seal or Packing	See Table A, B, C or D, Page 55		
16	Coupler	See Coupler Selection Table, Page 53		
ANSI/OSHA Coupling Guard & Support Bracket Kit Selection, See Page 54				
PARTS FOR PUMPS WITH 1⁵/₈" SHAFT AT SEAL				
2	Impeller (State Diameter) 12 ⁹ / ₁₆ " - 13 ¹ / ₂ "	P78535	P78535	P77532 [†]
2	Impeller (State Diameter) 12 ¹ / ₂ " or Less	P77513	P77513	P77532 [†]
8	Impeller Capscrew	P13800	P13800	P13800
9	Impeller Lockwasher	J23875	J23875	J23875
10	Impeller Washer	P51230	P51230	P46382
20	Impeller Key (Straight) Aug. 1989 (H98) and After	P49372	P49372	P49372
20	Impeller Key (Woodruff) July 1989 (G98) and Before	H32700	H32700	H32700
17	Coupler Key (Straight) Aug. 1989 (H98) and After	P49373	P49373	P49373
17	Coupler Key (Woodruff) July 1989 (G98) and Before	H32600	H32600	H32600
4	Volute Coverplate	P51562	P51562	P51562
44	Bracket	P85025	P85025	P85025
18	Bearing Frame Assembly Consisting of:	185323	185323	185323
33	Bearing Frame	P85016	P85016	P85016
35	Shaft	P85018	P85018	P85018
36	Bearing Cap	P85065	P85065	P85065
41	Ball Bearing – Pump End	186571	186571	186571
42	Ball Bearing – Coupler End	186572	186572	186572
27	i-ALERT Condition Monitor	185400	185400	185400
34	Spring Washer	J92560	J92558	J92560
37	Bearing Cap Capscrew (4)	DJ0034	DJ0034	DJ0034
19	Water Slinger	P77320	P77320	P77320
PARTS FOR PUMPS WITH 2³/₈" SHAFT AT SEAL				
2	Impeller (State Diameter) 13 ¹ / ₂ " Full Dia.	P51432	P51432	P51434 [†]
8	Impeller Capscrew	J92019	J92019	J92019
9	Impeller Lockwasher	J23876	J23876	J23876
10	Impeller Washer	P46384	P46384	P46385
20	Impeller Key	J93448	J93448	J93448
17	Coupler Key	J93448	J93448	J93448
4	Volute Coverplate	P51566	P51566	P51566
44	Bracket	P51576	P51576	P51576
18	Bearing Frame Assembly Consisting of:	P51705	P51705	P51705
33	Bearing Frame	P51572	P51572	P51572
35	Shaft	P79012	P79012	P79012
36	Bearing Cap – Pump End	P51582	P51582	P51582
	Bearing Cap – Coupler End	P51584	P51584	P51584
41	Ball Bearing – Pump End	J92413	J92413	J92413
42	Ball Bearing – Coupler End	J92414	J92414	J92414
27	i-ALERT Condition Monitor	185400	185400	185400
	Bearing Retainer Ring	J92385	J92385	J92385
	Bearing Locknut	J92388	J92388	J92388
	Bearing Lockwasher	J92389	J92389	J92389
37	Bearing Cap Capscrew (8)	DJ0071	DJ0071	DJ0071
19	Water Slinger	P81917	P81917	P81917

*Includes Wear Ring.

■ – Factory recommended spare parts.

[†]Consult factory for delivery.

8G

ITEM NO.	DESCRIPTION	PUMP CONSTRUCTION		
		BRONZE FITTED	BRONZE FITTED W/WEAR RING	ALL IRON
1	Volute	AC0274	AC0274	AC0274
43	Volute Wear Ring	—	AC0769	—
5	Volute Capscrew (8)	P13810	P13810	P13810
3	Volute O-Ring	AC0543	AC0543	AC0543
26	Seal (EPR/Carbon/Ni-Resist)	186574	186574	186574
26	Seal (Buna/Carbon/Ceramic)	P70517	P70517	P70517
26	Seal (EPR/Carbon/Tungsten Carbide)	AC3049	AC3049	AC3049
45	Spacer Sleeve	AC0573	AC0573	AC0573
30	Gland	AC0664	AC0664	AC0664
21	Gland Stud (2)	AC0581	AC0581	AC0581
22	Gland Nut (2)	AC0501	AC0501	AC0501
	Coupler	See Coupler Selection Table, Page 53		
ANSI/OSHA Coupling Guard & Support Bracket Kit Selection, See Page 54				
2	Impeller (State Diameter) 13" Full Dia.	AC0394	—	AC0395
2	Impeller for Wear Ring (State Diameter) 13" Full Dia.	—	AC1225	—
44	Impeller Nut	AC0584	AC0584	AC0584
10	Impeller Washer	AC0503	AC0503	AC0503
11	Shaft Sleeve (Bronze)	P2000133	P2000133	NONE
11	Shaft Sleeve (Stainless Steel)	AC0608	AC0608	AC0608
4	Volute Coverplate	AC0306	AC0306	AC0306
43	Coverplate Wear Ring	—	AC0769	—
	Bearing Frame Assembly Consisting of:	186006	186006	186006
33	Bearing Frame	AC0480	AC0480	AC0480
35	Shaft	AC0734	AC0734	AC0734
36	Bearing Cap (2)	AC0702	AC0702	AC0702
41 & 42	Ball Bearing (2)	186572	186572	186572
27	i-ALERT Condition Monitor	185400	185400	185400
46	Shaft Retainer Ring	AC0516	AC0516	AC0516
47	Retainer Ring (Outboard)	AC0515	AC0515	AC0515
48	Retainer Ring (Inboard)	AC0512	AC0512	AC0512
	Coupler Key	AC0525	AC0525	AC0525
20	Impeller Key	AC0524	AC0524	AC0524
19	Water Slinger	AC0621	AC0621	AC0621
	Pipe Plug	AC0532	AC0532	AC0532
	Grease Fitting (2)	P70614	P70614	P70614
	Support Foot Capscrew	S43640	S43640	S43640
	Support Foot Lockwasher	P16690	P16690	P16690
50	Bearing Support Foot	AC0930	AC0930	AC0930
49	By-Pass Piping Consisting of:			
	Tubing (2 ft.)	X42104	X42104	X43501
	Elbow	AC0533	AC0533	AC0531
	Connector	AC0535	AC0535	AC0536
	Connector	NONE	NONE	AC0537

■ – Factory recommended spare parts.

TB Wood's & Lovejoy Coupler Selection Table

PUMP SIZE	FRAME SIZE	SHAFT SPACE	H.P.	MOTOR SHAFT SIZE	COUPLER 16	SLEEVE FOR WOOD'S COUPLER	SPIDER FOR LOVEJOY COUPLER
FOR PUMPS WITH SMALL BEARING FRAME 1" SHAFT AT COUPLER	56	1 1/4"	1/2-3/4	5/8"	186868	P78804(4J)	P45540
	143T-145T	1 3/4"	1 - 1 1/2 - 2 - 3	7/8"	186869	P78804(4J)	P45540
	182T-184T	1 3/4"	2 - 3 - 5 - 7 1/2	1 1/8"	186870	P78729(5J)	P45540
	213T	2 1/2"	5 - 7 1/2 - 10	1 3/8"	186871	P78791(6J)	P45532
	215T	2 1/2"	7 1/2 - 10 - 15	1 3/8"	186871	P78791(6J)	P45532
	254T	2 1/2"	15 - 20	1 5/8"	186873	P78792(7S)	P45532
	256T	2 1/2"	20 - 25	1 5/8"	P63240	P78794(8S)	P45532
FOR PUMPS WITH LARGE BEARING FRAME 1 1/4" SHAFT AT COUPLER	213T	3 3/4"	7 1/2	1 3/8"	186872	P78791(6J)	P45532
	215T	3 3/4"	10	1 3/8"	186872	P78791(6J)	P45532
	254T	3 3/4"	15	1 5/8"	P63239	P78792(7S)	P45532
	256T	3 3/4"	20	1 5/8"	186874	P78794(8S)	—
	284T	3 3/4"	25	1 7/8"	P63242	P78794(8S)	—
	284T	4"	25	1 7/8"	P63243	P78794(8S)	—
	286T	3 3/4"	30	1 7/8"	P63244	P78796(9S)	—
	286T	4"	30	1 7/8"	P63244	P78796(9S)	—
	284TS	3 3/4"	30	1 5/8"	P63239	P78792(7S)	P45532
	286TS	3 3/4"	40	1 5/8"	186874	P78794(8S)	P45532
	324T	4"	40	2 1/8"	P63245	P78796(9S)	—
	326T	4"	50	2 1/8"	P63247	P78798(10S)	—
	324TS	3 3/4"	50	1 7/8"	P63242	P78794(8S)	—
	326TS	3 3/4"	60	1 7/8"	P63244	P78796(9S)	—
	364T	4"	60	2 3/8"	P63248	P78798(10S)	—
	364TS	4"	60-75	1 7/8"	P63244	P78796(9S)	—
	365T	4"	75	2 3/8"	P63250	P78802(11S)	—
365TS	4"	75-100	1 7/8"	P63246	P78798(10S)	—	
404TS	4"	100-125	2 1/8"	P63253	P78802(11S)	—	
FOR 5G AND 6G PUMPS WITH EXTRA LARGE BEARING FRAME 1 7/8" SHAFT AT COUPLER**	324T	5 3/8"	50	2 1/8"	P82161 P82162	P78796	—
	326T	5 3/8"	50	2 1/8"	P82096 P82097	P82098	—
	364TS	5 3/8"	60	1 7/8"	P82096 2 REQ'D	P82098	—
	365TS	5 3/8"	75	1 7/8"	P82158 2 REQ'D	P82142	—
	404TS	5 3/8"	100	2 1/8"	P82158 P82141	P82142	—
	405TS	5 3/8"	125	2 1/8"	P82161 P82162	P82144	—
FOR 8G PUMPS WITH EXTRA LARGE BEARING FRAME [†] 1 5/8" SHAFT AT COUPLER**	284T	1 1/2"	25	1 7/8"	AC1471 AC1472	AC1444	—
	286T	1 1/2"	30	1 7/8"	AC1471 AC1472	AC1444	—
	324T	1 1/2"	40	2 1/8"	AC1475 AC1477	AC1445	—
	326T	1 1/2"	50	2 1/8"	AC1475 AC1477	AC1445	—
	364T	3"	60	2 3/8"	AC1483 AC1480	P78802	—
	365T	3"	75	2 3/8"	AC1483 AC1480	P78802	—
	364TS	3 5/8"	60	1 7/8"	AC1481 AC1480	P78802	—
	365TS	3 5/8"	75	1 7/8"	AC1481 AC1480	P78802	—
	404TS	3 5/8"	100	2 1/8"	AC1485 AC1486	P81933	—
	405TS	3 5/8"	125	2 1/8"	AC1485 AC1486	P81933	—
	444TS	3 5/8"	150	2 3/8"	52-219-923-519 AC1485	P81933	—
	445TS	3 5/8"	200	2 3/8"	52-219-923-519 AC1485	P81933	—

**SPACER TYPE COUPLER USED ON THESE PUMPS. TO OBTAIN COMPLETE COUPLER, SPECIFY BOTH HALVES AND SLEEVE.

— Factory recommended spare parts.

[†]Consult factory if coupler is needed for an 8G pump manufactured before 2001.

Rexnord Omega Coupler Selection Table

PUMP SIZE	FRAME SIZE	H.P.	ELEMENT	PUMP HUB	MOTOR HUB
FOR PUMPS WITH SMALL BEARING FRAME 1" SHAFT AT COUPLER	56	0.333, 0.5, .75	P2000258	P2000296	P2000294
	143T-145T	0.75, 1, 1.5, 2, 3	P2000258	P2000296	P2000295
	182T-184T	1.5, 3, 5, 7.5	P2000258	P2000296	P2000293
	213T-215T	3, 5, 7.5, 10, 15	P2000263	P2000299	P2000302
	254T-256T	7.5, 15, 20, 25, 30	P2000266	P2000305	P2000309
FOR PUMPS WITH LARGE BEARING FRAME 1 1/4" SHAFT AT COUPLER	213T-215T	3, 5, 7.5, 10, 15	P2000262	P2000301	P2000302
	254T-256T	7.5, 10, 15*, 20**, 25, 30	P2000266	P2000307	P2000309
	256T	15***, 20****	P2000268	P2000314	P2000316
	284T	15, 20, 25	P2000269	P2000314	P2000317
	284TS	25, 30	P2000265	P2000307	P2000309
	284TS	40	P2000269	P2000314	P2000316
	286T	20, 25, 30	P2000271	P2000322	P2000325
	286TS	30, 40, 50	P2000269	P2000314	P2000316
	324T	25, 30, 40	P2000271	P2000322	P2000326
	324TS	40, 50	P2000269	P2000314	P2000317
	326T	30, 40, 50	P2000275	P2000330	P2000334
	326TS	50, 60+	P2000271	P2000322	P2000325
	326TS	60++	P2000272	P2000322	P2000325
	364T	40, 50, 60	P2000275	P2000330	P2000335
	364TS	60+++	P2000275	P2000330	P2000333
	364TS	60++++, 75	P2000271	P2000322	P2000325
	365T	60, 75	P2000278	P2000339	P2000344
	365TS	75#	P2000278	P2000339	P2000342
	365TS	75##, 100	P2000275	P2000330	P2000333
	404TS	75, 100	P2000278	P2000339	P2000343
404TS	125	P2000275	P2000330	P2000334	
FOR 8G PUMPS WITH EXTRA LARGE BEARING FRAME 1 5/8" SHAFT AT COUPLER	284T	15, 20	P2000267	P2000316	P2000317
	286T	20, 25	P2000270	P2000324	P2000325
	324T	25, 30, 40	P2000270	P2000324	P2000326
	326T	30, 40, 50	P2000273	P2000332	P2000334
	364T	40, 50, 60	P2000275	P2000332	P2000335
	364TS	50	P2000275	P2000332	P2000333
	365T	50, 60, 75	P2000278	P2000341	P2000344
	365TS	60	P2000278	P2000341	P2000342
	404TS	75, 100	P2000278	P2000341	P2000342
	405TS	100, 125	P2000281	P2000352	P2000354
444TS	150	P2000281	P2000352	P2000355	
FOR 5G AND 6G PUMPS WITH EXTRA LARGE BEARING FRAME 1 7/8" SHAFT AT COUPLER	324T	25, 40	P2000271	P2000325	P2000326
	326T	30, 50	P2000274	P2000333	P2000334
	364T	40, 60	P2000274	P2000333	P2000335
	364TS	60	P2000274	P2000333	P2000333
	365T	75	P2000277	P2000342	P2000344
	365TS	75	P2000277	P2000342	P2000342
	404TS	100	P2000277	P2000342	P2000343
	405TS	125	P2000280	P2000353	P2000354

* Not at 1450 RPM

** Not at 1750 RPM

*** Only at 1450 RPM

**** Only at 1750 RPM

+ Not for 2BC

++ Only for 2BC

+++ Only at 1750 RPM

++++ Not at 1750 RPM

Only at 1750 RPM

Not at 1750 RPM

 - Factory recommended spare parts.

ANSI/OSHA Guard & Support Bracket Kit Selection Chart for Standard EPDM Coupling

Coupler Guard Kit Part Numbers: 1=186884 2=186885 3=186887 4=186888
5=186889 6=185327

PUMP SIZE	BEARING FRAME	MOTOR FRAME / GUARD KIT NUMBER														SUPPORT BRACKET KIT												
		56	143T	145T	182T	184T	213T	215T	254T	256T	284T	284TS	286T	286TS	324T		324TS	326T	326TS	364T	364TS	365T	365TS	404TS	405TS	444TS	445TS	
1 1/4AB & 1 1/4AC	SMALL	1	1	1	1	1	1	1	2																			186905 186906
1 1/2AB & 1 1/2AC	SMALL	1	1	1	1	1	1	1	2																			186905 186906
2AB & 2AC	SMALL	1	1	1	1	1	1	1	2	2																		186905 186906
2 1/2A & 2 1/2AB	SMALL	1	1	1	1	1	1	1	2	2																		186905 186906
3AB & 3AC	SMALL	1	1	1	1	1																						186905 186904
	LARGE						2	2	2	2																		186905 186906
4AB & 4AC	SMALL	1	1	1	1	1																						186906
	LARGE						2	2	2	2					2	2												186905 186906
5A	SMALL				1	1	1	1																				186908
	LARGE								2	2	2	2	2	2	2	2	2	2										186907
1 1/4BB & 1 1/4BC	SMALL	1	1	1	1																							186906
	LARGE						2	2	2	2			2	2														186905 186906
1 1/2BB & 1 1/2BC	SMALL	1	1	1	1	1																						186906
	LARGE						2	2	2				2	2		2	2											186905 186906
2BB & 2BC	SMALL	1	1	1	1	1																						186906
	LARGE						2	2	2			2	2		2	2												186905 186906
2 1/2B & 2 1/2BB	SMALL		1	1	1	1	1																					186906
	LARGE						2	2				2	2		2	2			2									186905 186906
3BB & 3BC	SMALL			1	1	1	1	2																				186906
	LARGE										2	2		2	2		2	2		2								186905 186906
4BB & 4BC	SMALL				1	1	1	2																				186908
	LARGE								2	2	2	2	2	2	2	2			2				3	6				186907 186910
5BB & 5BC	SMALL					1	1	2																				186911
6BB & 6BC	LARGE						2	2	2	2	2	2	2	2	2	2												186908
	SMALL				1	1	1	1	2																			186908
2E	SMALL													2	2	2												186907
	LARGE												2	2	2	2			2				3					186910 186908
3E	SMALL					1	1	1	2																			186908
	LARGE									2						2	2			2			3	6				186907 186910
4E	SMALL					1	1	2																				186908
	LARGE								2	2			2	2	2	2	2			2			3	6	6			186907 186910
5E	LARGE						2	2	2	2	2	2	2	2	2	2												186908
6E	LARGE						2	2	2	2	2	2	2	2	2	2			4									186910
2CB & 2G	LARGE						2	2	2	2	2	2	2	2	2	2												186907
3CB & 3G	LARGE						2	2	2	2	2	2	2	2	2	2												186907
4CB, 4G & 4GB	LARGE						2	2	2	2	2	2	2	2	2	2												186908
5CB & 5G	LARGE								2	2	2	2	2	2	2	2			4			3						186910
	X-LARGE																4			4		4						186913
6CB & 6G	LARGE								2	2		2	2	2	2	2			4		3		6					186910
	X-LARGE (a)														4	4			4		4		4	4	4			186913
	X-LARGE (b)														4	4			4		6		6	5				186913
8G	X-LARGE									2		2	2	2	2	2			6	3	6	3	3	3	3	3	3	186916

(a) Standard Hytel Coupler
(b) EPDM Sleeve Option

HOW TO USE THIS CHART TO SELECT A COUPLER GUARD AND BRACKET KIT:

Example (shaded gray above): Pump Model = 4AC w/ a 20 HP, 208-230/460 Volt, 3 PH, 3600 RPM, 254T Fr. motor. The Coupler Guard kit is 186885 and the support bracket kit is 186905.

Mechanical Seals for Stuffing Box Type Pumps*

ITEM NO.	DESCRIPTION	NUMBER REQUIRED	1-1/4" SHAFT	1-5/8" SHAFT	2-3/8" SHAFT
----------	-------------	-----------------	--------------	--------------	--------------

TABLE A - ALL IRON AND BRONZE FITTED – SINGLE SEAL – SERIES S

26	Seal Assembly EPR/Carbon/Tungsten Carbide	1	P85070	185050	P63308
24	Seal Cap	1	P85082	P85086	P51592
21	Seal Cap Capscrew	4	H28100	H28100	DJ0071
22	Seal Cap Nut	4	P52380	P52380	NONE
23	Seal Cap Washer	4	P10910	P10910	NONE
25	Seal Cap Gasket	1	P85077	P85078	P80768
11	Shaft Sleeve	1	P85075	185022	P78743

TABLE B - ALL IRON AND BRONZE FITTED PUMPS – DOUBLE SEAL – SERIES D

29	Seal Assembly EPR/Carbon/Ceramic	1	P85066	186843	NOT OFFERED
27	Seal Cap	1	P85090	P85094	
21	Seal Cap Capscrew	4	H28100	H28100	
22	Seal Cap Nut	4	P52380	P52380	
23	Seal Cap Washer	4	P10910	P10910	
28	Seal Cap Gasket	1	NONE	P85078	
11	Shaft Sleeve	1	P85075	185022	

Packing Sets for Stuffing Box Type Pumps*

ITEM NO.	DESCRIPTION	NUMBER REQUIRED	1-1/4" SHAFT	1-5/8" SHAFT	2-3/8" SHAFT
----------	-------------	-----------------	--------------	--------------	--------------

TABLE C - BRONZE FITTED PUMPS – SERIES PF

31	Packing Ring Set (4 Piece to Each Set)	1 Set	P82070	P82072	P82015
32	Lantern Ring Set (2 Halves to Each Set)	1 Set	P84985	P84986	P84988
30	Packing Gland Halves	2	P85048	P85050	P51595
21	Packing Gland Capscrew	2	J92052	J92052	J92051
22	Seal Cap Nut	2	J91659	J91659	NONE
23	Seal Cap Gasket	2	J91649	J91649	J91649
11	Shaft Sleeve	1	P85075	185022	P78743

TABLE D - ALL IRON PUMPS – SERIES PF

31	Packing Ring Set (4 Pieces to Each Set)	1 Set	P82070	P82072	P82015
32	Lantern Ring (2 Halves to Each Set)	1 Set	P84985	P84986	P84988
30	Packing Gland Halves	2	P85049	P85051	P51596
21	Packing Gland Capscrew	2	J92052	J92052	J92051
22	Packing Gland Nut	2	J91659	J91659	NONE
23	Packing Gland Washer	2	J91649	J91649	J91649
11	Shaft Sleeve	1	P85075	185022	P78743

NOTE: Bronze Fitted Pumps are designated "BF" on nameplate.

All Iron Pumps are designated "AI" on nameplate.

Bronze Fitted Pumps with wearing rings are designated "BFW" on nameplate.

Standard Design Bronze Fitted Pumps (sizes 6G and smaller) with EPR/Carbon Tungsten Carbide seals are designated "BFE" on the nameplate. Bronze Fitted Pumps with Stuffing Box Construction and EPR/Carbon/Tungsten Carbide seals are designated "-S" on the nameplate. Standard design 1510 8G pumps are -S Construction with EPR/Carbon/Ni-Resist seals and are designated "BFE" on the nameplate. See page 52 for 8G seal selection.

■ – Factory recommended spare parts.

*Do not use this page for 8G pumps. See page 52 for 8G seal selection.

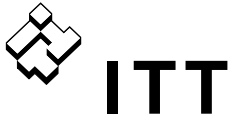

© Copyright 2011 ITT Corporation
Printed in U.S.A. 2-11

THE ITT ENGINEERED BLOCKS SYMBOL AND
ENGINEERED FOR LIFE ARE REGISTERED
TRADEMARKS OF ITT MANUFACTURING
ENTERPRISES, INC.

ITT
8200 N. Austin Avenue
Morton Grove, IL 60053
Phone: (847) 966-3700
Fax: (847) 966-9052
www.bellgossett.com