

Series e-1510

REPLACEMENT PARTS FOR STANDARD DESIGN PUMPS

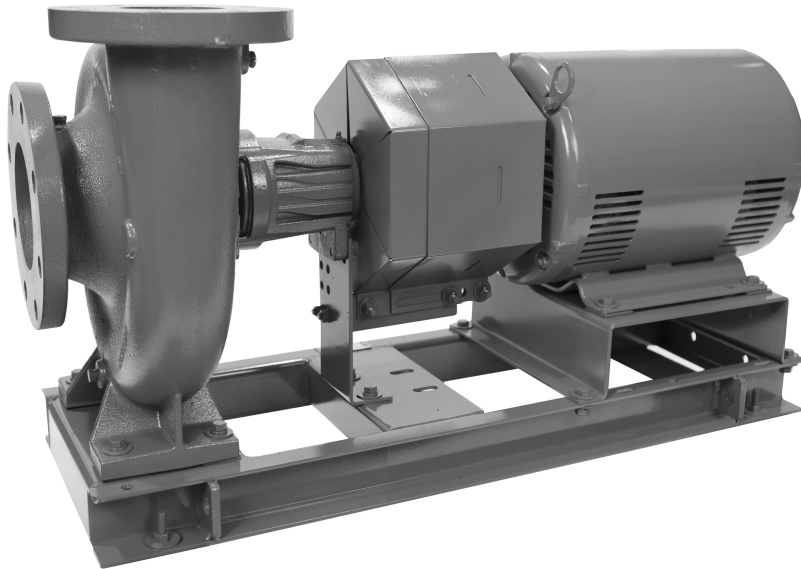

Index

Nameplate Data	3
Exploded Views	4
1.25AD-es, 1.5AD-es, 2AD-es, 2.5AC-es	5
1.25AD, 1.5AD, 2AD, 2.5AC, 3AD, 4AD, 5A	6
1.25BC, 1.5BC, 2BD, 2.5BB, 3BD, 4BD, 5BD, 6BD	7
2EB, 3EB, 4EB, 5EB, 6E	8
2GB, 3GB, 4GC, 5GB, 6G, 8GB	9
TB Woods Sure-Flex Coupling Selection Table	10
Rexnord Omega Coupling Selection Table	11
ANSI/OSHA Guard & Bracket Kit Selection Table	12
Galvanized Drip Pans	13
Accessories	14

Nameplate Data

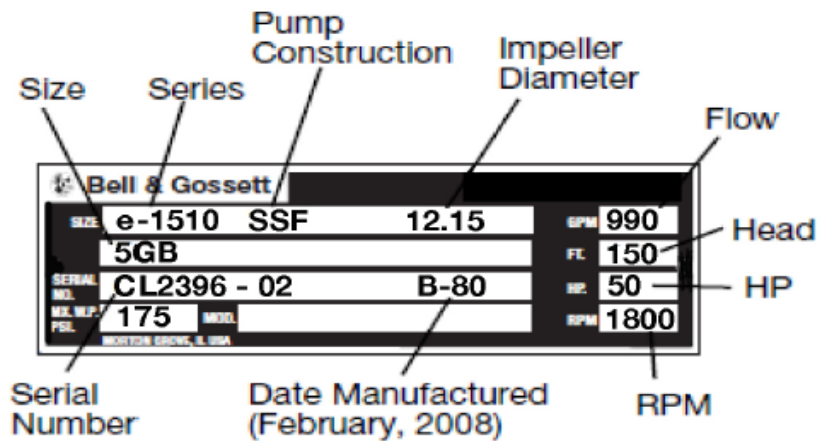

The pump nameplate identifies the pump by pipe size, pump construction and impeller diameter as shown above. In this example, the nameplate shows a Series e-1510, size 5GB in stainless steel fitted (SSF) construction. The pump was furnished with a 12.15" impeller diameter and a 50 horsepower, 1800 RPM synchronous speed motor. The serial number specifically identifies the unit for future reference.

DO NOT REMOVE THE NAMEPLATE. It is important when ordering replacement parts to furnish complete nameplate data.

The e-1510 pump is furnished with both "Standard Seal" or "Stuffing Box" configuration. The "Standard Seal" pump has no seal designation after the Series number on the nameplate. If the example pump was of "Stuffing Box" configuration, the nameplate would show it to be a e-1510-S or e-1510-PF pump. Parts for "Stuffing Box" type pumps are covered under the CP-209-PL parts list.

To ensure the correct parts are selected, use the following procedure:

1. Determine from nameplate the pump size, seal configuration, pump construction and impeller diameter.
2. Measure shaft sleeve diameter at the seal.
3. Refer to the index for the page number of the parts breakdown for the specific size pump.
5. Select part numbers using the exploded view numbered drawing for identification. Where shaft diameter affects parts selection, use the measurement secured in Step 2.

Standard Seal Design Pump Exploded View

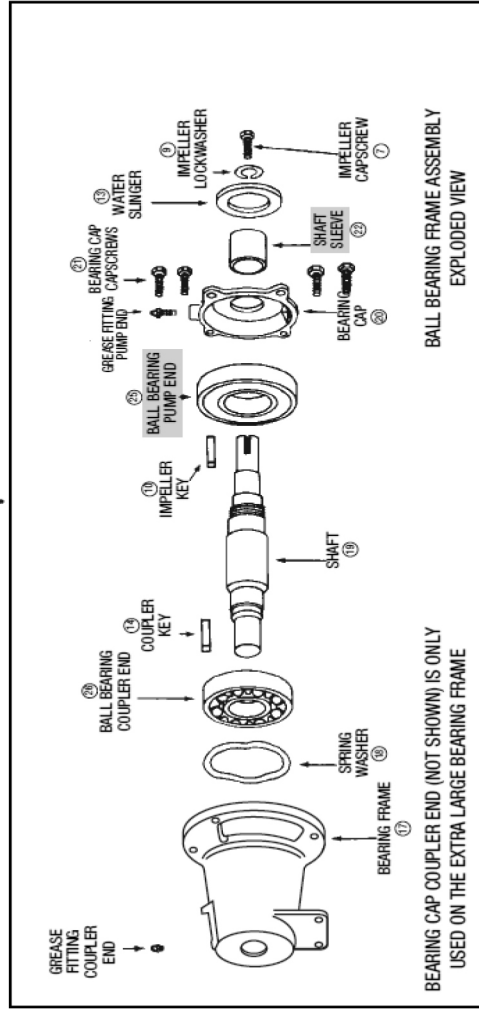
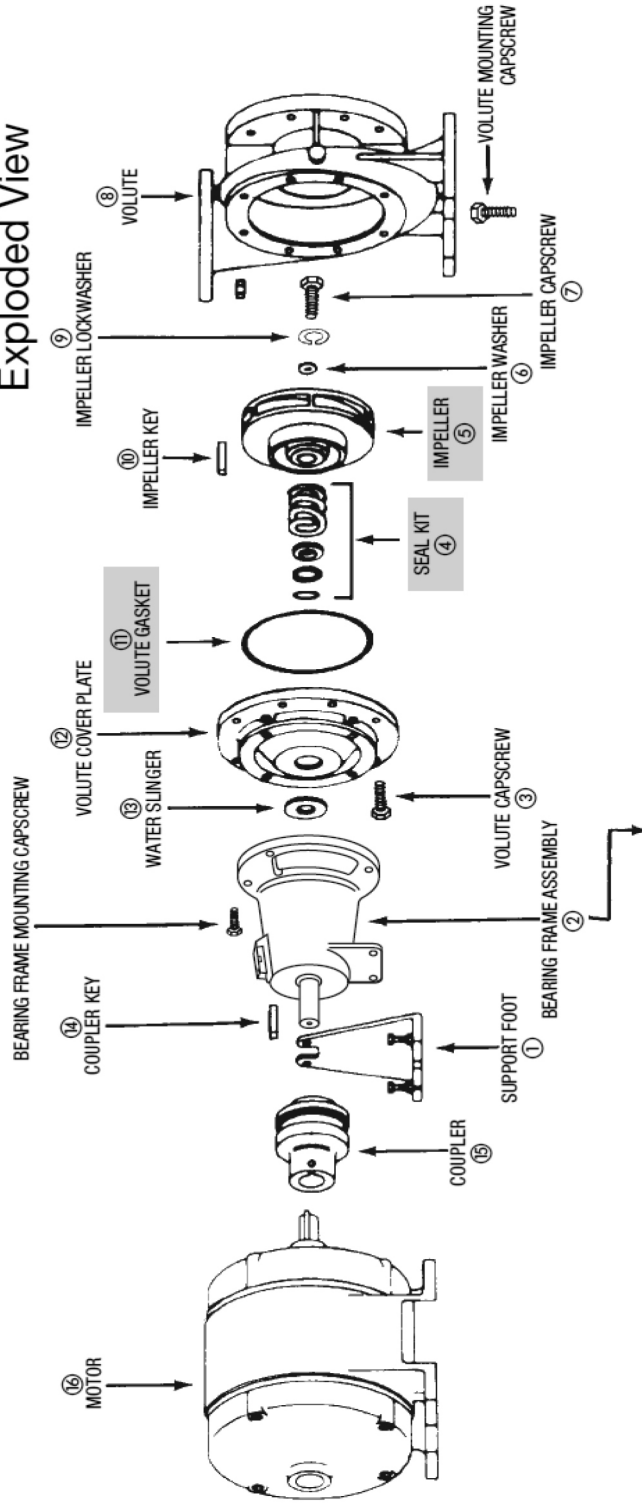

- Factory recommended spare parts.

ITEM	DESCRIPTION (QTY)	1.25AD-es	1.5AD-es	2AD-es	2.5AC-es
8	Volute (175 MWP)	P2000822	P2000838	P2000852	P2000848
	Volute (175 MWP) with Stainless Steel Wear Ring	P2000899	P2000900	P2001194	P2000901
	Stainless Steel Wear Ring	P2001179	P2001180	P2001195	P2001181
	Volute Drain Plug (4)	P39020	P39020	P39040	P39040
11	Volute Gasket	P57700	P57700	P57700	P57700
15	See Coupling Selection Table				
	See ANSI/OSHA Guard & Bracket Kit Selection Table				
Parts for Pumps With 0.625" Shaft Sleeve Diameter at Mechanical Seal (Extra Small Bore)					
5	Impeller (State Diameter) 7" Full Diameter	P2001163	P2001164	P2001147	P2001165
12	Volute Coverplate	186498	186498	186498	186498
12	Volute Coverplate – "-F" Construction	P2001186	P2001186	P2001186	P2001186
3	Volute Capscrew (8)	P40020	P40020	P40020	P40020
4	Seal Kit BUNA / Carbon vs Silicon Carbide	P2001175	P2001175	P2001175	P2001175
4	Seal Kit EPR / Silicon Carbide vs Tungsten Carbide	P2001176	P2001176	P2001176	P2001176
4	Seal Kit FKM / Carbon vs Silicon Carbide	P2001177	P2001177	P2001177	P2001177
4	Seal Kit EPR / Silicon Carbide vs Silicon Carbide	P2001178	P2001178	P2001178	P2001178
2	Complete Bearing Frame Assembly	185150	185150	185150	185150
17	Bearing Frame	P2001125	P2001125	P2001125	P2001125
19	Shaft	P2001152	P2001152	P2001152	P2001152
7	Impeller Nut	P2001398	P2001398	P2001398	P2001398
14	Coupling Key	P49373	P49373	P49373	P49373
13	Water Slinger	P53550	P53550	P53550	P53550
18	Spring Washer	J92558	J92558	J92558	J92558
20	Bearing Cap	P75606	P75606	P75606	P75606
21	Bearing Cap Capscrew (4)	J92291	J92291	J92291	J92291
25	Ball Bearing - Pump End	186002NG	186002NG	186002NG	186002NG
26	Ball Bearing - Coupling End	186001NG	186001NG	186001NG	186001NG
22	Stainless Steel Shaft Sleeve Kit	185145	185145	185145	185145

ITEM	DESCRIPTION (QTY)	1.25AD	1.5AD	2AD	2.5AC	3AD	4AD	5A
8	Volute (175 MWP)	P2000822	P2000838	P2000852	P2000848	P2000856	P2000832	P43663
	Volute (175 MWP) with Stainless Steel Wear Ring	P2000899	P2000900	P2001194	P2000901	P2000902	P2000904	P2001642
	Stainless Steel Wear Ring	P2001179	P2001180	P2001195	P2001181	P2001182	P2001183	P2001645
	Volute Drain Plug (4)	P39020	P39020	P39040	P39040	P39040	P39040	P39040
11	Volute Gasket	P57700	P57700	P57700	P57700	P57700	P57700	P57700
15	Coupling - See Selection Table							
	See ANSI/OSHA Guard & Bracket Kit Selection Table							
Parts for Pumps With 1.25" Shaft Sleeve Diameter at Mechanical Seal (Small Bore)								
5	Impeller (State Diameter) 7" Full Diameter	P2000824	P2000840	P2000854	P2000850	P2000858	P2000919	P2001003
6	Impeller Washer	P46380	P46380	P46380	P46380	P46380	P46380	P46380
12	Volute Coverplate	186482	186482	186482	186482	186482	186482	186482
12	Volute Coverplate - "F" Construction	P61131	P61131	P61131	P61131	P61131	P61131	P61131
3	Volute Capscrew (8)	P40020	P40020	P40020	P40020	P40020	P40020	P40020
4	Seal Kit Buna / Carbon vs Ceramic	186862LF	186862LF	186862LF	186862LF	186862LF	186862LF	186862LF
4	Seal Kit EPR / Carbon vs Tungsten Carbide	186861LF	186861LF	186861LF	186861LF	186861LF	186861LF	186861LF
4	Seal Kit FKM / Carbon vs Ceramic	P95503	P95503	P95503	P95503	P95503	P95503	P95503
4	Seal Kit EPR / Silicon Carbide vs Silicon Carbide	P75423	P75423	P75423	P75423	P75423	P75423	P75423
2	Complete Bearing Frame Assembly	185011LF	185011LF	185011LF	185011LF	185011LF	185011LF	185011LF
17	Bearing Frame	P2001125	P2001125	P2001125	P2001125	P2001125	P2001125	P2001125
19	Shaft	P78927	P78927	P78927	P78927	P78927	P78927	P78927
7	Impeller Capscrew	P52350	P52350	P52350	P52350	P52350	P52350	P52350
9	Impeller Lockwasher	J23874	J23874	J23874	J23874	J23874	J23874	J23874
10	Impeller Key	P49369	P49369	P49369	P49369	P49369	P49369	P49369
14	Coupling Key	P49373	P49373	P49373	P49373	P49373	P49373	P49373
13	Water Slinger	P53550	P53550	P53550	P53550	P53550	P53550	P53550
18	Spring Washer	J92558	J92558	J92558	J92558	J92558	J92558	J92558
20	Bearing Cap	P75606	P75606	P75606	P75606	P75606	P75606	P75606
21	Bearing Cap Capscrew (4)	J92291	J92291	J92291	J92291	J92291	J92291	J92291
25	Ball Bearing - Pump End	186002NG	186002NG	186002NG	186002NG	186002NG	186002NG	186002NG
26	Ball Bearing - Coupling End	186001NG	186001NG	186001NG	186001NG	186001NG	186001NG	186001NG
22	Stainless Steel Shaft Sleeve Kit	185141	185141	185141	185141	185141	185141	185141
Parts for Pumps With 1.625" Shaft Sleeve Diameter at Mechanical Seal (Large Bore)								
5	Impeller (State Diameter) 7" Full Diameter	Not Available	P2001149	P2000909	P2000860	P2000921	P2001005	
6	Impeller Washer		P51230	P51230	P51230	P51230	P51230	
12	Volute Coverplate		P49940	P49940	P49940	P49940	P49940	
12	Volute Coverplate - "F" Construction		P49941	P49941	P49941	P49941	P49941	
3	Volute Capscrew (8)		P44250	P44250	P44250	P44250	P44250	
4	Seal Kit Buna / Carbon vs Ceramic		186543LF	186543LF	186543LF	186543LF	186543LF	
4	Seal Kit EPR / Carbon vs Tungsten Carbide		185225LF	185225LF	185225LF	185225LF	185225LF	
4	Seal Kit FKM / Carbon vs Ceramic		P77046	P77046	P77046	P77046	P77046	
4	Seal Kit EPR / Silicon Carbide vs Silicon Carbide		P75424	P75424	P75424	P75424	P75424	
2	Complete Bearing Frame Assembly		185014LF	185014LF	185014LF	185014LF	185014LF	
17	Bearing Frame		P2001127	P2001127	P2001127	P2001127	P2001127	
19	Shaft		P79027	P79027	P79027	P79027	P79027	
7	Impeller Capscrew		P13800	P13800	P13800	P13800	P13800	
9	Impeller Lockwasher		J23875	J23875	J23875	J23875	J23875	
10	Impeller Key		P49372	P49372	P49372	P49372	P49372	
14	Coupling Key		P49373	P49373	P49373	P49373	P49373	
13	Water Slinger		P53720	P53720	P53720	P53720	P53720	
18	Spring Washer		J92560	J92560	J92560	J92560	J92560	
20	Bearing Cap		P75612	P75612	P75612	P75612	P75612	
21	Bearing Cap Capscrew (4)		DJ0066	DJ0066	DJ0066	DJ0066	DJ0066	
25	Ball Bearing - Pump End		186571NG	186571NG	186571NG	186571NG	186571NG	
26	Ball Bearing - Coupling End		186572NG	186572NG	186572NG	186572NG	186572NG	
22	Stainless Steel Shaft Sleeve Kit	185143	185143	185143	185143	185143		

ITEM	DESCRIPTION (QTY)	2EB	3EB	4EB	5EB	6E
8	Volute (175 MWP)	P2000872	P2001169	P2000894	P2001144	P43972
	Volute (175 MWP) with Stainless Steel Wear Ring	P2001659	P2002305	P2001668	P2002314	P2002323
	Stainless Steel Wear Ring	P2001666	P2002312	P2001675	P2002321	P2002329
	Volute Drain Plug (4)	P39040	P39040	P39040	P39040	P39040
3	Volute Capscrew (16)	P13780	P13780	P13780	P13780	P13780
11	Volute Gasket	P80765	P80765	P80765	P80765	P80765
15	Coupling - See Selection Table					
	For ANSI/OSHA Coupling Guard & Support Bracket Kit Selection					
Parts for Pumps With 1.25" Shaft Sleeve Diameter at Mechanical Seal (Small Bore)						
5	Impeller (State Diameter) 11" Full Diameter	P2000874	P2001171	P2000896	Not Available	
6	Impeller Washer	P46380	P46380	P46380		
12	Volute Coverplate	P53042	P53042	P53042		
12	Volute Coverplate – "-F" Construction	P53043	P53043	P53043		
4	Seal Kit Buna / Carbon vs Ceramic	186862LF	186862LF	186862LF		
4	Seal Kit EPR / Carbon vs Tungsten Carbide	186861LF	186861LF	186861LF		
4	Seal Kit FKM / Carbon vs Ceramic	P95503	P95503	P95503		
4	Seal Kit EPR / Silicon Carbide vs Silicon Carbide	P75423	P75423	P75423		
2	Complete Bearing Frame Assembly	185011LF	185011LF	185011LF		
17	Bearing Frame	P2001125	P2001125	P2001125		
19	Shaft	P78927	P78927	P78927		
7	Impeller Capscrew	P52350	P52350	P52350		
9	Impeller Lockwasher	J23874	J23874	J23874		
10	Impeller Key	P49369	P49369	P49369		
14	Coupling Key	P49373	P49373	P49373		
13	Water Slinger	P53550	P53550	P53550		
18	Spring Washer	J92558	J92558	J92558		
20	Bearing Cap	P75606	P75606	P75606		
21	Bearing Cap Capscrew (4)	J92291	J92291	J92291		
25	Ball Bearing - Pump End	186002NG	186002NG	186002NG		
26	Ball Bearing - Coupling End	186001NG	186001NG	186001NG		
22	Stainless Steel Shaft Sleeve Kit	185141	185141	185141		
Parts for Pumps With 1.625" Shaft Sleeve Diameter at Mechanical Seal (Large Bore)						
5	Impeller (State Diameter) 11" Full Diameter	P2000876	P2001173	P2000898	P2001146	P2001741
6	Impeller Washer	P51230	P51230	P51230	P51230	P51230
12	Volute Coverplate	P53046	P53046	P53046	P53046	P53046
12	Volute Coverplate – "-F" Construction	P53047	P53047	P53047	P53047	P53047
4	Seal Kit Buna / Carbon vs Ceramic	186543LF	186543LF	186543LF	186543LF	186543LF
4	Seal Kit EPR / Carbon vs Tungsten Carbide	185225LF	185225LF	185225LF	185225LF	185225LF
4	Seal Kit FKM / Carbon vs Ceramic	P77046	P77046	P77046	P77046	P77046
4	Seal Kit EPR / Silicon Carbide vs Silicon Carbide	P75424	P75424	P75424	P75424	P75424
2	Complete Bearing Frame Assembly	185014LF	185014LF	185014LF	185014LF	185014LF
17	Bearing Frame	P2001127	P2001127	P2001127	P2001127	P2001127
19	Shaft	P79027	P79027	P79027	P79027	P79027
7	Impeller Capscrew	P13800	P13800	P13800	P13800	P13800
9	Impeller Lockwasher	J23875	J23875	J23875	J23875	J23875
10	Impeller Key	P49372	P49372	P49372	P49372	P49372
14	Coupling Key	P49373	P49373	P49373	P49373	P49373
13	Water Slinger	P53720	P53720	P53720	P53720	P53720
18	Spring Washer	J92560	J92560	J92560	J92560	J92560
20	Bearing Cap	P75612	P75612	P75612	P75612	P75612
21	Bearing Cap Capscrew (4)	DJ0066	DJ0066	DJ0066	DJ0066	DJ0066
25	Ball Bearing - Pump End	186571NG	186571NG	186571NG	186571NG	186571NG
26	Ball Bearing - Coupling End	186572NG	186572NG	186572NG	186572NG	186572NG
22	Stainless Steel Shaft Sleeve Kit	185143	185143	185143	185143	185143

ITEM	DESCRIPTION (QTY)	1.25BC	1.5BC	2BD	2.5BB	3BD	4BD	5BD	6BD
8	Volute (175 MWP)	P41620	P41780	P2000842	P42542	P2000826	P2000862	P2000913	P2001162
	Volute (175 MWP) with Stainless Steel Wear Ring	P2001189	P2001646	P2001650	P2002291	P2000903	P2001196	P2001199	P2002296
	Stainless Steel Wear Ring	P2001184	P2001649	P2001653	P2002294	P2001185	P2001197	P2001202	P2002303
	Volute Drain Plug (4)	P39020	P39020	P39040	P39040	P39040	P39040	P39040	P39040
3	Volute Capscrew (12)	P03470	P03470	P03470	P03470	P03470	P03470	P03470	P03470
11	Volute Gasket	P48690	P48690	P48690	P48690	P48690	P48690	P48690	P48690
15	Coupling - See Selection Table								
	See ANSI/OSHA Guard & Bracket Kit Selection Table								
Parts for Pumps With 1.25" Shaft Sleeve Diameter at Mechanical Seal (Small Bore)									
5	Impeller (State Diameter) 9.5" Full Diameter	P2001007	P2001011	P2000844	P2001745	P2000828	P2000864	P2000915	Not Available
6	Impeller Washer	P46380	P46380	P46380	P46380	P46380	P46380	P46380	
12	Volute Coverplate	186495	186495	186495	186495	186495	186495	186495	
12	Volute Coverplate – "F" Construction	P61451	P61451	P61451	P61451	P61451	P61451	P61451	
4	Seal Kit Buna / Carbon vs Ceramic	186862LF	186862LF	186862LF	186862LF	186862LF	186862LF	186862LF	
4	Seal Kit EPR / Carbon vs Tungsten Carbide	186861LF	186861LF	186861LF	186861LF	186861LF	186861LF	186861LF	
4	Seal Kit FKM / Carbon vs Ceramic	P95503	P95503	P95503	P95503	P95503	P95503	P95503	
4	Seal Kit EPR / Silicon Carbide vs Silicon Carbide	P75423	P75423	P75423	P75423	P75423	P75423	P75423	
2	Complete Bearing Frame Assembly	185011LF	185011LF	185011LF	185011LF	185011LF	185011LF	185011LF	
17	Bearing Frame	P2001125	P2001125	P2001125	P2001125	P2001125	P2001125	P2001125	
19	Shaft	P78927	P78927	P78927	P78927	P78927	P78927	P78927	
7	Impeller Capscrew	P52350	P52350	P52350	P52350	P52350	P52350	P52350	
9	Impeller Lockwasher	J23874	J23874	J23874	J23874	J23874	J23874	J23874	
10	Impeller Key	P49369	P49369	P49369	P49369	P49369	P49369	P49369	
14	Coupling Key	P49373	P49373	P49373	P49373	P49373	P49373	P49373	
13	Water Slinger	P53550	P53550	P53550	P53550	P53550	P53550	P53550	
18	Spring Washer	J92558	J92558	J92558	J92558	J92558	J92558	J92558	
20	Bearing Cap	P75606	P75606	P75606	P75606	P75606	P75606	P75606	
21	Bearing Cap Capscrew (4)	J92291	J92291	J92291	J92291	J92291	J92291	J92291	
25	Ball Bearing - Pump End	186002NG	186002NG	186002NG	186002NG	186002NG	186002NG	186002NG	
26	Ball Bearing - Coupling End	186001NG	186001NG	186001NG	186001NG	186001NG	186001NG	186001NG	
22	Stainless Steel Shaft Sleeve Kit	185141	185141	185141	185141	185141	185141	185141	
Parts for Pumps With 1.625" Shaft Sleeve Diameter at Mechanical Seal (Large Bore)									
5	Impeller (State Diameter) 9.5" Full Diameter	P2001009	P2001013	P2000846	P2001747	P2000830	P2000866	P2000917	P2000870
6	Impeller Washer	P51230	P51230	P51230	P51230	P51230	P51230	P51230	P51230
12	Volute Coverplate	P51540	P51540	P51540	P51540	P51540	P51540	P51540	P51540
12	Volute Coverplate – "F" Construction	P51541	P51541	P51541	P51541	P51541	P51541	P51541	P51541
4	Seal Kit Buna / Carbon vs Ceramic	186543LF	186543LF	186543LF	186543LF	186543LF	186543LF	186543LF	186543LF
4	Seal Kit EPR / Carbon vs Tungsten Carbide	185225LF	185225LF	185225LF	185225LF	185225LF	185225LF	185225LF	185225LF
4	Seal Kit FKM / Carbon vs Ceramic	P77046	P77046	P77046	P77046	P77046	P77046	P77046	P77046
4	Seal Kit EPR / Silicon Carbide vs Silicon Carbide	P75424	P75424	P75424	P75424	P75424	P75424	P75424	P75424
2	Complete Bearing Frame Assembly	185014LF	185014LF	185014LF	185014LF	185014LF	185014LF	185014LF	185014LF
17	Bearing Frame	P2001127	P2001127	P2001127	P2001127	P2001127	P2001127	P2001127	P2001127
19	Shaft	P79027	P79027	P79027	P79027	P79027	P79027	P79027	P79027
7	Impeller Capscrew	P13800	P13800	P13800	P13800	P13800	P13800	P13800	P13800
9	Impeller Lockwasher	J23875	J23875	J23875	J23875	J23875	J23875	J23875	J23875
10	Impeller Key	P49372	P49372	P49372	P49372	P49372	P49372	P49372	P49372
14	Coupling Key	P49373	P49373	P49373	P49373	P49373	P49373	P49373	P49373
13	Water Slinger	P53720	P53720	P53720	P53720	P53720	P53720	P53720	P53720
18	Spring Washer	J92560	J92560	J92560	J92560	J92560	J92560	J92560	J92560
20	Bearing Cap	P75612	P75612	P75612	P75612	P75612	P75612	P75612	P75612
21	Bearing Cap Capscrew (4)	DJ0066	DJ0066	DJ0066	DJ0066	DJ0066	DJ0066	DJ0066	DJ0066
25	Ball Bearing - Pump End	186571NG	186571NG	186571NG	186571NG	186571NG	186571NG	186571NG	186571NG
26	Ball Bearing - Coupling End	186572NG	186572NG	186572NG	186572NG	186572NG	186572NG	186572NG	186572NG
22	Stainless Steel Shaft Sleeve Kit	185143	185143	185143	185143	185143	185143	185143	185143

ITEM	DESCRIPTION (QTY)	2GB	3GB	4GC	5GB	6G	8GB
8	Volute (175 MWP)	P2000890	P2000886	P2000882	P2001167	P44081	P2001155
	Volute (175 MWP) with Stainless Steel Wear Ring	P2002339	P2002348	P2001677	P2001204	P2002331	P2001654
	Stainless Steel Wear Ring	P2002346	P2002355	P2001684	P2001207	P2002337	P2001657
	Volute Drain Plug (4)	P39040	P39040	P39040	P39040	P39040	P39040
	Volute Capscrew (16)	P13780	P13780	P13780	P13780	P13780	P13780
11	Volute Gasket	P80767	P80767	P80767	P80767	P80767	P80767
15	Coupling - See Selection Table						
	See ANSI/OSHA Guard & Bracket Kit Selection Table						
Parts for Pumps With 1.625" Shaft Sleeve Diameter at Mechanical Seal (Large Bore)							
5	Impeller (State Diameter) 13.5" Full Diameter	P2000892	P2000888	P2000884	P2000880	P2001742	P2001157
6	Impeller Washer	P51230	P51230	P51230	P51230	P51230	P51230
12	Volute Coverplate	P51561	P51561	P51561	P51561	P51561	P51561
12	Volute Coverplate - "F" Construction	P51567	P51567	P51567	P51567	P51567	P51567
4	Seal Kit Buna / Carbon vs Ceramic	186543LF	186543LF	186543LF	186543LF	186543LF	186543LF
4	Seal Kit EPR / Carbon vs Tungsten Carbide	185225LF	185225LF	185225LF	185225LF	185225LF	185225LF
4	Seal Kit FKM / Carbon vs Ceramic	P77046	P77046	P77046	P77046	P77046	P77046
4	Seal Kit EPR / Silicon Carbide vs Silicon Carbide	P75424	P75424	P75424	P75424	P75424	P75424
2	Complete Bearing Frame Assembly	185014LF	185014LF	185014LF	185014LF	185014LF	185014LF
17	Bearing Frame	P2001127	P2001127	P2001127	P2001127	P2001127	P2001127
19	Shaft	P79027	P79027	P79027	P79027	P79027	P79027
7	Impeller Capscrew	P13800	P13800	P13800	P13800	P13800	P13800
9	Impeller Lockwasher	J23875	J23875	J23875	J23875	J23875	J23875
10	Impeller Key	P49372	P49372	P49372	P49372	P49372	P49372
14	Coupling Key	P49373	P49373	P49373	P49373	P49373	P49373
13	Water Slinger	P53720	P53720	P53720	P53720	P53720	P53720
18	Spring Washer	J92560	J92560	J92560	J92560	J92560	J92560
20	Bearing Cap	P75612	P75612	P75612	P75612	P75612	P75612
21	Bearing Cap Capscrew (4)	DJ0066	DJ0066	DJ0066	DJ0066	DJ0066	DJ0066
25	Ball Bearing - Pump End	186571NG	186571NG	186571NG	186571NG	186571NG	186571NG
26	Ball Bearing - Coupling End	186572NG	186572NG	186572NG	186572NG	186572NG	186572NG
22	Stainless Steel Shaft Sleeve Kit	185143	185143	185143	185143	185143	185143
Parts for Pumps with 2.375" Shaft Sleeve Diameter at Mechanical seal (Extra Large Bore)							
5	Impeller (State Diameter) 13.5" Full Diameter					P2001744	P2001158
6	Impeller Washer					P46384	P46384
12	Volute Coverplate					P51564	P51564
12	Volute Coverplate - "F" Construction					P51568	P51568
4	Seal Kit Buna / Carbon vs Ceramic					186828LF	186828LF
4	Seal Kit EPR / Carbon vs Tungsten Carbide					186836LF	186836LF
4	Seal Kit FKM / Carbon vs Ceramic					P2001693	P2001693
4	Seal Kit EPR / Silicon Carbide vs Silicon Carbide					P2001694	P2001694
2	Complete Bearing Frame Assembly					185320LF	185320LF
17	Bearing Frame					P2001129	P2001129
19	Shaft					P79011	P79011
7	Impeller Capscrew					J92019	J92019
9	Impeller Lockwasher					J23876	J23876
10	Impeller Key					J93448	J93448
14	Coupling Key					J93448	J93448
13	Water Slinger					P81917	P81917
20	Bearing Cap - Pump End					P51582	P51582
	Bearing Cap - Coupling End					P51584	P51584
	Bearing Retainer					J92385	J92385
	Bearing Locknut					J92388	J92388
	Bearing Lockwasher					J92389	J92389
21	Bearing Cap Capscrew (8)					DJ0071	DJ0071
25	Ball Bearing - Pump End					P2002427	P2002427
26	Ball Bearing - Coupling End					P2002428	P2002428
22	Stainless Steel Shaft Sleeve Kit					185148	185148

Not Available

TB Wood's Sure-Flex Coupling Selection Table

SHAFT SIZE	FRAME SIZE	SHAFT GAP (INCH)	H.P.	MOTOR SHAFT DIAMETER (INCH)	COMPLETE COUPLING (Includes Pump Flange, Motor Flange, Neoprene Sleeve)		NEOPRENE SLEEVE FOR WOOD'S COUPLING
FOR PUMPS WITH EXTRA SMALL AND SMALL BEARING FRAMES 1" SHAFT DIAMETER AT COUPLING	56	1.25	0.5 - 0.75	0.625	186868		P78804 (4J)
	143T-145T	1.75	1 - 1.5 - 2 - 3	0.875	186869		P78804 (4J)
	182T-184T	1.75	2 - 3 - 5 - 7.5	1.125	186870		P78729 (5J)
	213T	2.5	5 - 7.5 - 10	1.375	186871		P78791 (6J)
	215T	2.5	7.5 - 10 - 15	1.375	186871		P78791 (6J)
	254T	2.5	15 - 20	1.625	186873		P78792 (7S)
	256T	2.5	20 - 25	1.625	P63240		P78794 (8S)
FOR PUMPS WITH LARGE BEARING FRAME 1.25" SHAFT DIAMETER AT COUPLING	213T	3.75	7.5	1.375	186872		P78791 (6J)
	215T	3.75	10	1.375	186872		P78791 (6J)
	254T	3.75	15	1.625	P63239		P78792 (7S)
	256T	3.75	20	1.625	186874		P78794 (8S)
	284T	3.75	25	1.875	P63242		P78794 (8S)
	284T	4	25	1.875	P63243		P78794 (8S)
	286T	3.75	30	1.875	P63244		P78796 (9S)
	286T	4	30	1.875	P63244		P78796 (9S)
	284TS	3.75	30	1.625	P63239		P78792 (7S)
	286TS	3.75	40	1.625	186874		P78794 (8S)
	324T	4	40	2.125	P63245		P78796 (9S)
	326T	4	50	2.125	P63247		P78798 (10S)
	324TS	3.75	50	1.875	P63242		P78794 (8S)
	326TS	3.75	60	1.875	P63244		P78796 (9S)
	364T	4	60	2.375	P63248		P78798 (10S)
	364TS	4	60 - 75	1.875	P63244		P78796 (9S)
365T	4	75	2.375	P63250		P78802 (11S)	
365TS	4	75 - 100	1.875	P63246		P78798 (10S)	
404TS	4	100 - 125	2.125	P63253		P78802 (11S)	
SHAFT SIZE	FRAME SIZE	SHAFT GAP (INCH)	H.P.	MOTOR SHAFT DIAMETER (INCH)	Pump Flange	Motor Flange	NEOPRENE SLEEVE FOR WOOD'S COUPLING
FOR PUMPS WITH EXTRA LARGE BEARING FRAME 1.875" SHAFT DIAMETER AT COUPLING	324T	5.375	30	2.125	P82641	P82165	P78798 (10E)
	326T	5.375	40	2.125	P82641	P82165	P78798 (10E)
	364TS	5.375	60	1.875	P82641	P82641	P78798 (10E)
	365TS	5.375	75	1.875	P82643	P82643	P78802 (11E)
	404TS	5.375	100	2.125	P82643	P82169	P78802 (11E)

Factory recommended spare parts.

Rexnord Omega Coupling Selection Table

PUMP SIZE	FRAME SIZE	H.P.	ELEMENT	PUMP HUB	MOTOR HUB
FOR PUMPS WITH "es" AND SMALL BEARING FRAME 1" SHAFT DIAMETER AT COUPLING	56	0.33, 0.5, 0.75	P2000258	P2000296	P2000294
	143T-145T	0.75, 1, 1.5, 2, 3	P2000258	P2000296	P2000295
	182T-184T	1.5, 3, 5, 7.5	P2000258	P2000296	P2000293
	213T-215T	3, 5, 7.5, 10, 15	P2000263	P2000299	P2000302
	254T-256T	7.5, 15, 20, 25, 30	P2000266	P2000305	P2000309
FOR PUMPS WITH LARGE BEARING FRAME 1.25" SHAFT DIAMETER AT COUPLING	213T-215T	3, 5, 7.5, 10, 15	P2000262	P2000301	P2000302
	254T-256T	7.5, 10, 15*, 20**, 25, 30	P2000266	P2000307	P2000309
	256T	15***, 20****	P2000268	P2000314	P2000316
	284T	15, 20, 25	P2000269	P2000314	P2000317
	284TS	25, 30	P2000265	P2000307	P2000309
	284TS	40	P2000269	P2000314	P2000316
	286T	20, 25, 30	P2000271	P2000322	P2000325
	286TS	30, 40, 50	P2000269	P2000314	P2000316
	324T	25, 30, 40	P2000271	P2000322	P2000326
	324TS	40, 50	P2000269	P2000314	P2000317
	326T	30, 40, 50	P2000275	P2000330	P2000334
	326TS	50, 60+	P2000271	P2000322	P2000325
	326TS	60++	P2000272	P2000322	P2000325
	364T	40, 50, 60	P2000275	P2000330	P2000335
	364TS	60+++	P2000275	P2000330	P2000333
	364TS	60++++, 75	P2000271	P2000322	P2000325
	365T	60, 75	P2000278	P2000339	P2000344
	365TS	75#	P2000278	P2000339	P2000342
	365TS	75##, 100	P2000275	P2000330	P2000333
	404TS	75, 100	P2000278	P2000339	P2000343
404TS	125	P2000275	P2000330	P2000334	
FOR PUMPS WITH EXTRA LARGE BEARING FRAME 1.875" SHAFT AT COUPLING	324T	25, 40	P2000271	P2000325	P2000326
	326T	30, 50	P2000274	P2000333	P2000334
	364T	40, 60	P2000274	P2000333	P2000335
	364TS	60	P2000274	P2000333	P2000333
	365T	75	P2000277	P2000342	P2000344
	365TS	75	P2000277	P2000342	P2000342
	404TS	100	P2000277	P2000342	P2000343
405TS	125	P2000280	P2000353	P2000354	

* Not at 1450 RPM

** Not at 1750 RPM

*** Only at 1450 RPM

**** Only at 1750 RPM

+ Not for 2BC

++ Only for 2BC

+++ Only at 1750 RPM

++++ Not at 1750 RPM

Only at 1750 RPM

Not at 1750 RPM

ANSI/OSHA Guard & Support Bracket Kit Selection

Chart for Standard TB Wood's Sure-Flex Neoprene Coupling

Coupling Guard Kit Part Numbers:

1 = 186884 2 = 186885 3 = 186887 4 = 186888 5 = 186889 6 = 185327

PUMP SIZE	BEARING FRAME	MOTOR FRAME / GUARD KIT NUMBER																				SUPPORT BRACKET KIT				
		56	143T	145T	182T	184T	213T	215T	254T	256T	284T	284TS	286T	286TS	324T	324TS	326T	326TS	364T	364TS	365T		365TS	404TS	405TS	
1.25AD-es	Extra Small	1	1	1	1	1	1	1																	186905	
1.25AD	Small	1	1	1	1	1	1	1																	186905	
									2																186906	
1.5AD-es	Extra Small	1	1	1	1	1	1	1																	186905	
1.5AD	Small	1	1	1	1	1	1	1																	186905	
									2																186906	
2AD-es	Extra Small	1	1	1	1	1	1	1																	186905	
2AD	Small	1	1	1	1	1	1	1																	186905	
									2	2															186906	
2.5AC-es	Extra Small	1	1	1	1	1	1	1																	186905	
2.5AC	Small	1	1	1	1	1	1	1																	186905	
									2	2															186906	
3AD	Small	1	1	1	1	1																			186905	
	Large						2	2																	186904	
									2	2															186905	
											2														186906	
4AD	Small		1	1	1	1	1																		186906	
	Large							2	2	2					2		2								186905	
													2												186906	
5A	Small				1	1	1	1																	186908	
	Large								2	2			2		2		2			2					186907	
1.25BC	Small		1	1	1	1							2		2										186906	
	Large							2	2	2															186905	
													2		2										186906	
1.5BC	Small		1	1	1	1	1																		186906	
	Large							2	2	2						2		2							186905	
													2		2										186906	
2BD	Small		1	1	1	1	1																		186906	
	Large							2	2	2						2		2							186905	
													2		2										186906	
2.5BB	Small			1	1	1	1	1																	186906	
	Large								2	2						2		2							186905	
													2		2					2					186906	
3BD	Small				1	1	1	1	2																186906	
	Large												2		2					2					186905	
													2		2					2					186906	
4BD	Small						1	1	2																186908	
	Large									2			2		2					2					186907	
																				2		3	6		186910	
5BD	Small						1	1	2																186911	
	Large									2	2		2		2										186908	
6BD	Large							2	2	2	2		2		2				2						186908	
2EB	Small				1	1	1	1	2																186908	
	Large												2		2		2								186907	
																			2			3			186910	
3EB	Small					1	1	1	2																186908	
	Large									2						2		2							186907	
																			2			3	6		186910	
4EB	Small						1	1	2																186908	
	Large										2	2			2		2								186907	
																			2			3	6	6	186910	
5EB	Large							2	2	2	2		2		2		2								186908	
6E	Large									2	2	2		2		2				4					186910	
2GB	Large							2	2	2	2		2		2										186907	
3GB	Large							2	2	2	2		2		2										186907	
4GC	Large							2	2	2	2		2		2										186908	
5GB	Large									2	2	2		2		2				4		3			186910	
	Large										2	2		2		2			4		3		6		186910	
6G	Extra Large													4		4						6	6	5	186913	
8GB	Large									2	2		2		2		2		4		3		6	6	186910	
	Extra Large													4		4			4		3		6	6	5	186913

HOW TO USE THIS CHART TO SELECT A COUPLING GUARD AND BRACKET KIT:

Example (shaded gray above): Pump Model = 4AD w/ a 20 HP, 208-230/460 Volt, 3 PH, 3600 RPM, 254T Fr. motor. The Coupling Guard Kit number is 186885 and the support bracket kit number is 186905.

Galvanized Steel Drip Pans

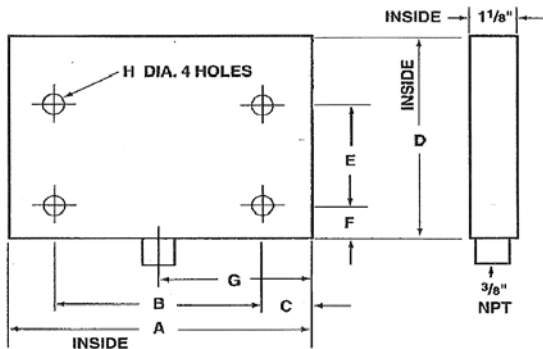

FIGURE 1

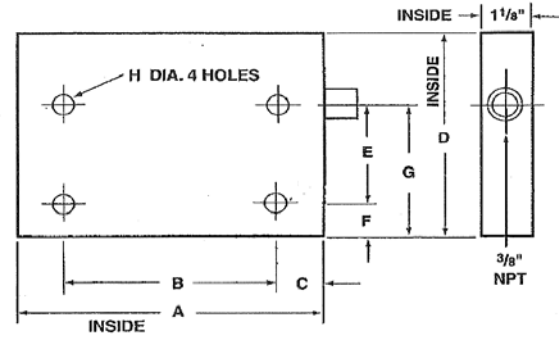

FIGURE 2

PUMP SIZE

PART NUMBER

- 1.25AD, 1.25AD-es, 1.5AD,
1.5AD-es, 2AD, 2AD-es,
2.5AC, 2.5AC-es, 3AD.....P85265
- 4AD, 5A, 1.25BC, 1.5BC,
2BD, 2.5BB, 3BD, 4BD.....P85266
- 5BD, 6BD, 2EB, 3EB, 4EB,
5EB, 2GB, 3GB, 4GC.....P85267
- 6E, 5GB, 6GP85268
- 8GB.....P82946

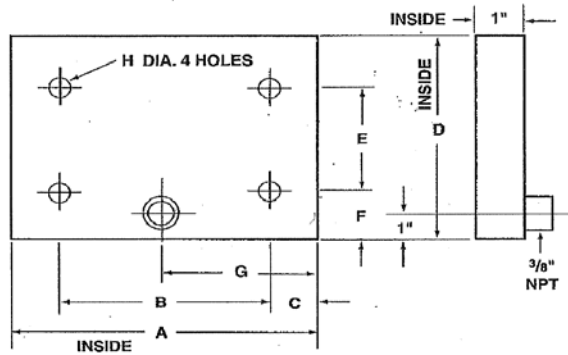

FIGURE 3

DIMENSIONS - INCHES

Part No.	Fig.	A	B	C	D	E	F	G	H
P85265	1	11	6-1/2	2-1/4	11-1/2	3	1-1/2	5-1/2	9/16
P85266	1	13-5/8	9-1/8	2-1/4	12-7/8	4-3/8	1-7/16	6-13/16	9/16
P85267	1	18-1/2	14	2-1/4	12-1/4	5	1-11/16	9-1/4	5/8
P85268	2	25-1/2	21	2-1/4	17	9	1-11/16	10-11/16	7/8
P82946	3	27	17-5/8	4-11/16	18-1/8	6-1/8	6	13-1/2	3/4

ACCESSORIES

Cuno Filter Kit

1.25AD, 1.25AD-es, 1.5AD, 1.5AD-es, 2AD, 2AD-es, 2.5AC, 2.5AC-es, 3AD, 4AD, 5A	P2001049
1.25BC, 1.5BC, 2BD, 2.5BB, 3BD, 4BD, 5BD, 6BD	P2001050
2EB, 3EB, 4EB, 5EB, 6E	P2001051
2GB, 3GB, 4GC, 5GB, 6G, 8GB	P2001052

Replacement Filter Cartridge

All e-1510 Sizes	P65085
------------------	--------

Sediment Separator Kit

1.25AD, 1.25AD-es, 1.5AD, 1.5AD-es, 1.25BC, 1.5BC	P2001043
2AD, 2AD-es, 2.5AC, 2.5AC-es, 3AD, 4AD, 5A, 2BD, 2.5BB, 3BD, 4BD, 5BD, 6BD, 2EB, 3EB, 4EB, 5EB, 6E, 2GB, 3GB, 4GC, 5GB, 6G, 8GB	P2001044

Heat Exchanger Kit

All e-1510 Sizes	186883
------------------	--------

Xylem |'zīləm|

- 1) The tissue in plants that brings water upward from the roots;
- 2) a leading global water technology company.

We're a global team unified in a common purpose: creating innovative solutions to meet our world's water needs. Developing new technologies that will improve the way water is used, conserved, and re-used in the future is central to our work. We move, treat, analyze, and return water to the environment, and we help people use water efficiently, in their homes, buildings, factories and farms. In more than 150 countries, we have strong, long-standing relationships with customers who know us for our powerful combination of leading product brands and applications expertise, backed by a legacy of innovation.

For more information on how Xylem can help you, go to www.xyleminc.com



Xylem Inc.
8200 N. Austin Avenue
Morton Grove, Illinois 60053
Phone: (847) 966-3700
Fax: (847) 965-8379
www.bellgossett.com

Bell & Gossett is a trademark of Xylem Inc. or one of its subsidiaries.
© 2016 Xylem Inc. CP-208G-PL November 2016