



**Application**



**AVDO** self-acting constant flow controls are used to maintain a minimum flow rate (e.g. through a low water content gas boiler) or to control differential pressure in a heating system. The closing of radiator or zone valves due to reduced heating demand may result in low flow and increased system differential pressure (potentially dead heating pumps). AVDO valves open with a falling system load and allow flow through a bypass line whenever the differential pressure through the valve exceeds set point; ensuring a minimum flow rate or a system differential pressure at minimum system load.

**AVDO:**

- Opens on rising differential pressure.
- Setting differential pressure range of 0.725 - 7.25 psi (0.05-0.5 bar).
- Designed for 145 psi (10 bar), max. 248°F (120°C).
- Operates without impulse tubes.
- Can be supplied with NPT or solder tail pieces.

**Application Examples:**

The placement of the AVDO can be piped between the supply and return or parallel to the circulator as seen in the figures below.

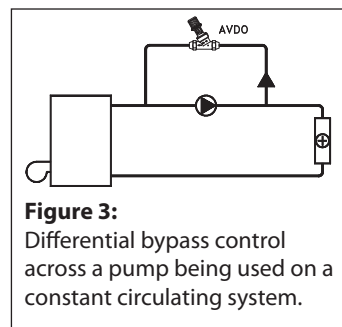
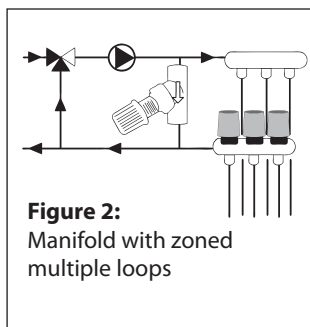
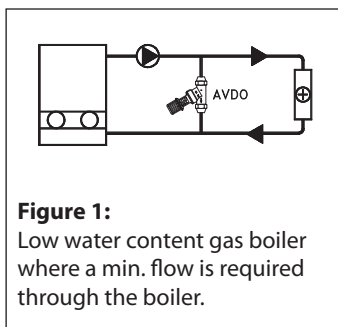

**Ordering**

Code Numbers	Type	Description	Size/Connection
<b>AVDO 15</b>	Straight Valve Body	1/2" Union Solder 1/2" Union Male, NPT	003L602001 003L602002
<b>AVDO 20</b>		3/4" Union Solder 3/4" Union Male, NPT	003L602501 003L602502
<b>AVDO 25</b>		1" Union Male, NPT	003L603002

**Technical data**

<b>Setting range</b>	0.725 - 7.25 psi (0.05 - 0.5 bar)
<b>Max. differential pressure</b>	7.25 psi (0.5 bar)
<b>Operation pressure</b>	145 psi (10 bar)
<b>Max. flow temperature</b>	248°F (120°C)
<b>Max. leakage when closed</b>	0.22 gpm (0.05 m <sup>3</sup> /h)

**Capacity**

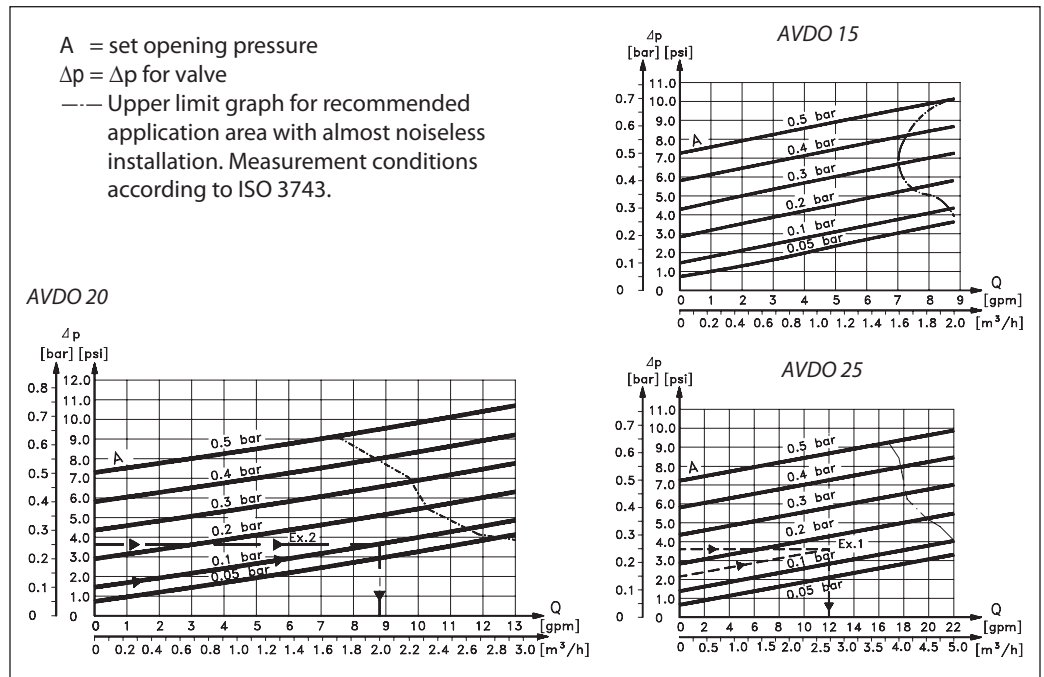

**Design**

**Materials of parts in contact with water**

<b>1. Setting handle</b>	Pom-Plastic
<b>2. Base</b>	Ms 58
<b>3. Spring guide</b>	Polyphenylene sulphide (PPS-plastics)
<b>4. Spring</b>	Stainless steel
<b>5. Valve cone</b>	Polyphenylene sulphide (PPS-plastics)
<b>6. Valve body</b>	Ms 58, forged
<b>7. Setting pin</b>	Stainless steel
<b>8. O-rings</b>	EPDM rubber

**Installation**

The valve body must be mounted with flow in the direction of the cast-in arrow.

**Setting**

The control is set by turning the adjustment knob. AVDO has a setting scale on which the opening pressure can be set according to the table to the right. The differential pressures stated for a given setting are indicative. The scale gives the differential pressure across the AVDO when it just begins to open.

0.1	-	1	=	1.45
0.2	-	2	=	2.90
0.3	-	3	=	4.35
0.4	-	4	=	5.8
0.5	-	5	=	7.25
bar		mH <sup>2</sup> O		psi

Sizing

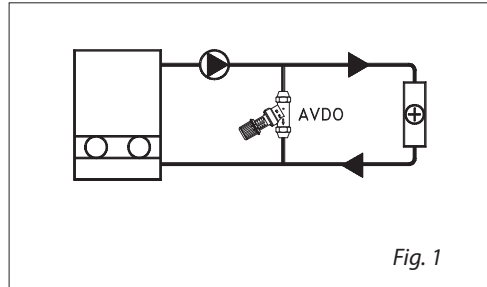

Fig. 1

**Example 1**

Bypass control across heating system

**Given:**

- System, see fig. 1
- Insignificant pressure loss in pipe from boiler to bypass.
- Pump characteristic, see fig. 2.
- 2.2 psi (0.15 bar) system differential pressure at max. system load.

**Required:**

- Bypass circulation beginning at 2.2 psi (0.15 bar) pump pressure.
- Min. 8.8 gpm (2.0 m<sup>3</sup>/h) boiler circulation

**Seek:**

- A constant flow control that opens simultaneously with falling load across the system (closing radiator valves or zone valves)
- A constant flow control that ensures min. 8.8 gpm (2.0 m<sup>3</sup>/h) boiler circulation at min. system load

**Solution:**

- An 8.8 gpm (2.0 m<sup>3</sup>/h) flow corresponds to a 3.6 psi (0.25 bar) pump pressure - see "Capacity".
- On closing radiator valves or zone valves AVDO ensures a minimum of 8.8 gpm (2.0 m<sup>3</sup>/h) circulation at 3.6 psi (0,25 bar) differential pressure across AVDO.
- Choose AVDO 25 that provides 12 gpm (2.7 m<sup>3</sup>/h) at 3.6 psi (0.25 bar) differential pressure across valve.
- Set AVDO to #1.5 (2.2 psi, 0.15 bar) opening pressure.

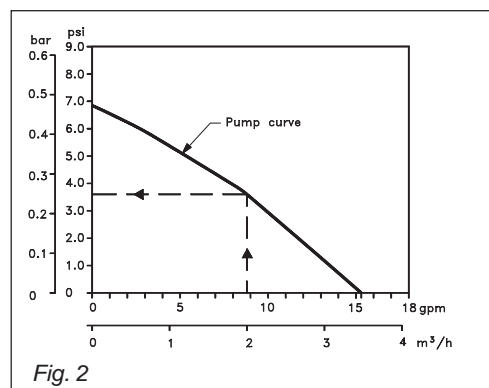

Fig. 2

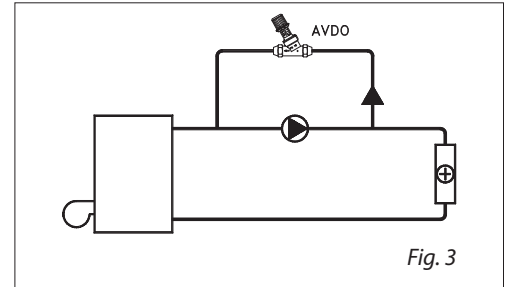

Fig. 3

**Example 2**

Bypass control across circulating pump

**Given:**

- System, see fig. 3
- Pump characteristic, see fig. 4

**Required:**

- Bypass circulation beginning at 1.5 psi (0.1 bar) pump pressure
- Max. system differential pressure with closed radiator valves or zone valves must be limited to 3.6 psi (0.25 bar)

**Seek:**

- A constant flow control that opens simultaneously with falling load across the system (closing radiator valves or zone valves)
- A constant flow control that ensures max. system differential pressure not to exceed 3.6 psi (0.25 bar) at min. system load

**Solution:**

- The max. permissible differential pressure 3.6 psi (0.25 bar) across the system corresponds to a 8 gpm (1.8 m<sup>3</sup>/h) water volume (fig. 4). At min. load AVDO must ensure 8 gpm (1.8 m<sup>3</sup>/h) in circulation through the bypass. In this example AVDO 20 must be used - see "Capacity".
- As circulation is not to begin before differential pressure across system has exceeded 1.5 psi (0.1 bar), AVDO is set to # 1.0 (1.5 psi, 0.1 bar) - see "Setting".

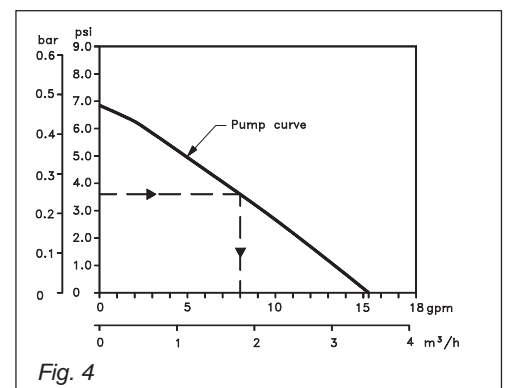
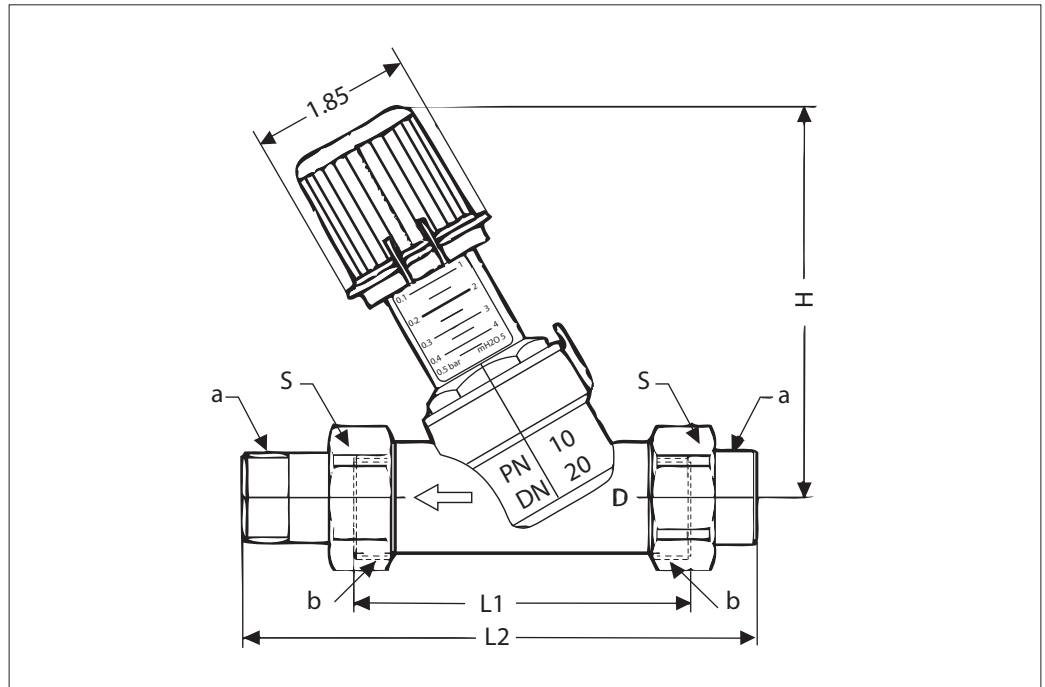

Fig. 4

Dimensions



DN	Type	Measure Unit	L1	L2 Threaded	L2 Solder	H		S	a	b ISO 228/1
						Min	Max			
15	AVDO 15	inch	3.44	5.94	4.76	3.50	4.45	1.18	1/2"	G 3/4 A
		mm	87	151	121	89	113	30		
20	AVDO 20	inch	3.66	6.49	5.39	3.55	4.49	1.46	3/4"	G 1 A
		mm	93	165	137	90	114	37		
25	AVDO 25	inch	4.17	7.00	-	3.74	4.69	4.69	1"	G 1 1/4 A
		mm	106	178	-	95	119	119		

Danfoss can accept no responsibility for possible errors in printed materials and reserves the right to alter its products without notice. All trademarks in this material are property of the respective companies. Danfoss and Danfoss logotype are trademarks of Danfoss A/S. All rights reserved.



**Danfoss**  
Toronto, ON  
Toll Free: 866-676-8062  
Tel.: 905-285-2050, Fax: 905-285-2055  
www.na.heating.danfoss.com

**Danfoss**  
Baltimore, MD  
Toll Free: 866-375-HVAC (4822)  
Tel.: 443-512-0266, Fax: 443-512-0270  
www.na.heating.danfoss.com