

CLASS 125 • LEAD FREE

Features

- Lead free compliant
- Available in sizes 1-6"

Specifications & Approvals

Dimension per B16.24
 Bronze Material is certified by ASTM B62
 Threaded ends conform to ASME B1.20.1
 Non serated facing meets MSS SP-6
 Bronze fittings conform to NSF61 & NSF372

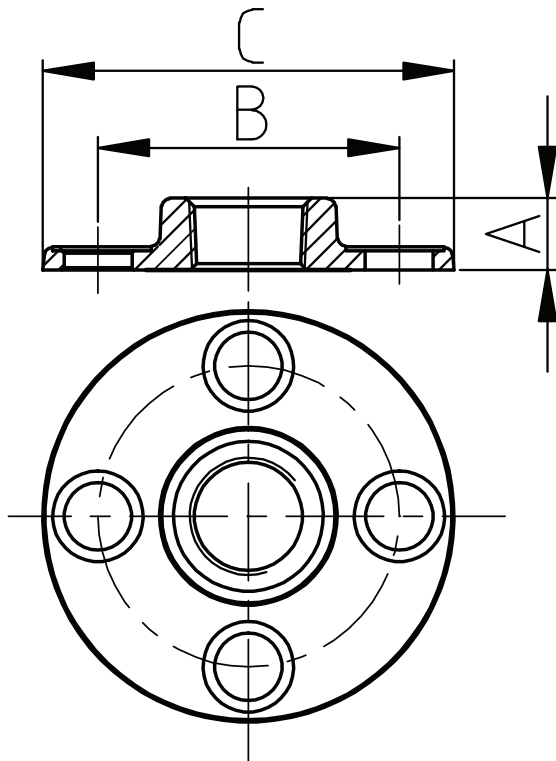
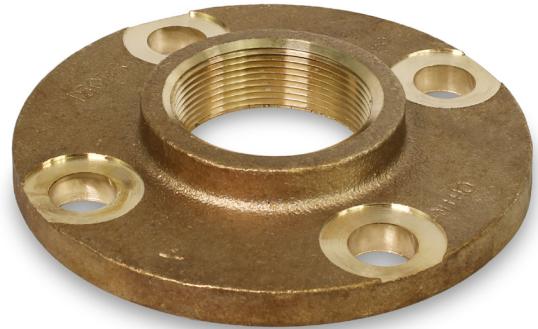

Dimensions

Part #	Size	A	B	C
BRCFI012-NL	1/2"	15	60.5	89
BRCFI034-NL	3/4"	15.8	70	98.5
BRCFI100-NL	1"	17.6	79.5	108
BRCFI114-NL	1-1/4"	20.6	90	117.5
BRCFI112-NL	1-1/2"	22.4	98.5	128
BRCFI200-NL	2"	25.4	120.5	151
BRCFI212-NL	2-1/2"	28.5	140	179.5
BRCFI300-NL	3"	30.3	152.5	192
BRCFI400-NL	4"	33.3	190.5	231

CLASS 125 • LEAD FREE

Features

- Lead free compliant
- Available in sizes 1-6"

Specifications & Approvals

100% air tested
 Manufactured at ISO 9001:2000 facilities
 Conforms to ASTM B62 and applicable ANSI standards
 NSF 61-4 and AB1953 Approved

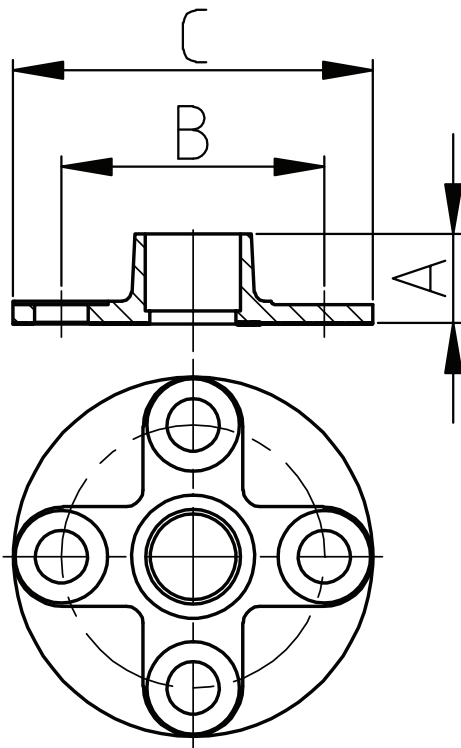

Dimensions

Part #	Size	A	B	C
BRCFS100-NL	1"	25	79.5	108
BRCFS114-NL	1-1/4"	27.4	90	117.5
BRCFS112-NL	1-1/2"	30.4	98.5	127
BRCFS200-NL	2"	36.7	120.5	152.4
BRCFS212-NL	2-1/2"	40.8	140	177.8
BRCFS300-NL	3"	45.5	152.5	190.5
BRCFS400-NL	4"	58	190.5	228.6