

Pneumatic Thermostat and Humidistat Cover Kit

INSTALLATION INSTRUCTIONS

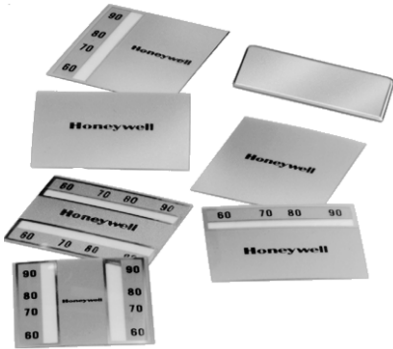

GENERAL

1. Determine whether thermostat is mounted vertically or horizontally.
2. Determine whether cover requires a setpoint and thermometer window or a blank window.
3. Select the appropriate window insert (Fig. 1).
4. Determine if a Setpoint Cover Insert is required. Generally, if the window is blank, the Setpoint Cover Insert is required.
5. Follow the instructions in Installation Section to assemble and mount the cover.

NOTE: Window Markings vary by kit number

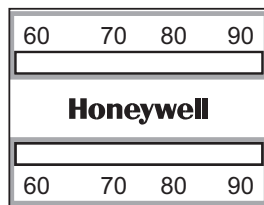

VERTICAL WINDOWS

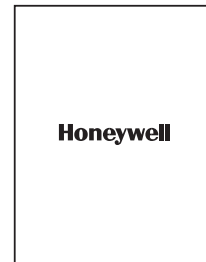
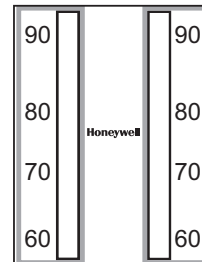

HORIZONTAL WINDOWS

C6692

Fig. 1. Windows

ASSEMBLY

1. Remove the caution card from the cover.
2. Peel the release liner from selected window back



CAUTION

To prevent damage to the window, carefully check the window selection and orientation before installing the window. Once assembled, disassembly may damage the window.

3. Ensure that the window is oriented correctly for the assembly. When viewed from the front of the cover, the setpoint and day/auto openings are on the bottom for a

vertical cover or on the right for a horizontal cover. The cover has slots which must mate with the mounting ears on the backplate.

- a. Insert the top edge of the window (Fig. 2) into the slot in the top of the window hole
- b. Bend the window slightly and pop the bottom edge into the slot in the bottom of the window hole.
- c. Press in place to secure window.



THERMOSTAT AND HUMIDISTAT COVER KIT

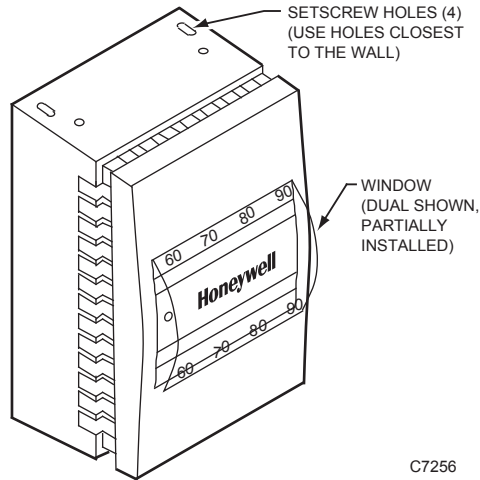
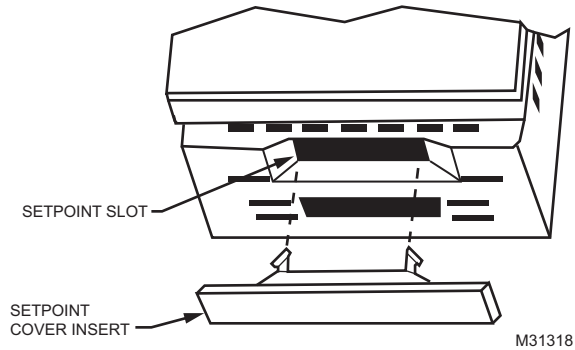

Fig. 2. Installation of window insert

C7256

- If a Setpoint Cover Insert is required, assemble per Figure 3.



M31318

Fig. 3. Setpoint cover insert

Pneumatic Cover Kit Part #'s	Description	Works with:
14004406-910	Satin Chrome Kit - Fahrenheit	TP970, TP971, TP972, TP973 and TP974
14004406-910C	Satin Chrome Kit - Celsius	TP970, TP971, TP972, TP973 and TP974
14004406-910H	Satin Chrome Kit - Humidistat	HP970, HP971 and HP972.
14004407-910	Beige Kit - Fahrenheit	TP970, TP971, TP972, TP973 and TP974
14004407-910C	Beige Kit - Celsius	TP970, TP971, TP972, TP973 and TP974
14004787-910	Bright Chrome Kit - Fahrenheit	TP970, TP971, TP972, TP973 and TP974
14004878-910	White Kit - Fahrenheit	TP970, TP971, TP972, TP973 and TP974

Table 1. Cover kits

MOUNTING

Mount the cover (Fig. 4) by hooking the two slots on the cover bottom (right end for horizontal mounting) on the mounting ears of the backplate. Swing the cover into place. Back out (counterclockwise) the setscrews with the Thermostat Tool (CCT735A) or a 0.050-inch Allen wrench to secure the cover.

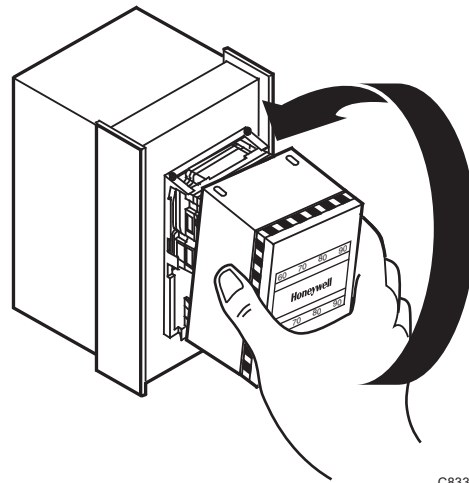

C8339

Fig. 4. Mounting cover

Automation and Control Solutions

Honeywell International Inc.
 1985 Douglas Drive North
 Golden Valley, MN 55422

Honeywell Limited-Honeywell Limitée
 35 Dynamic Drive
 Toronto, Ontario M1V 4Z9
 customer.honeywell.com

© U.S. Registered Trademark
 © 2010 Honeywell International Inc.
 95-7484—01 E.K. Rev. 03-10
 Printed in U.S.A.

