

VA-8122 Proportional Valve Actuator

The VA-8122 Proportional Valve Actuator is an electric actuator that provides proportional control of valves with up to a 5/16 in. stroke in Heating, Ventilating, and Air Conditioning (HVAC) applications. This compact, non-spring return actuator has a 22 lb minimum seating force in a compact, easy-to-install package.

The VA-8122 can be ordered factory coupled to the 1/2 in. or 3/4 in. VG7000 Series bronze valves for hot or cold water service only. The VA-8122 can be used for retrofits of VT Series Terminal Unit Valves (with slotted stems) and VB-5x39 Series Flare Valves. Refer to the appropriate valve literature for more information.



Figure 1: VA-8122-1 Valve Actuator

Features and Benefits		
q	AUTOCAL Pushbutton	Allows the actuator to define the control input range proportionally over the stroke
q	Simplified Setup and Adjustment Procedures	Reduces installation costs
q	Selectable Direction of Action, Drive Down (DD) or Drive Up (DU)	Provides application flexibility
q	Wide Range of Control Inputs (Voltage and Current)	Meets the needs of most applications
q	Power Failure Detection; Low Voltage Indication	Prevents data corruption of the actuator's memory and warns of insufficient supply voltage
q	Light-Emitting Diode (LED)	Reduces commissioning time and displays operating status

Operation

The actuator uses a reversible synchronous motor to accurately position the valve. The motor can reliably generate 22 pounds of force in either the Drive Down (DD) or Drive Up (DU) direction.

Once the valve closes, a shutoff force builds up. When this force reaches 22 pounds, a lever within the actuator operates a force sensor that stops the motor. The constant load at the end of travel ensures tight valve seat shutoff and compensates for seat wear.

Field calibration of shutoff is not required. The actuator maintains the shutoff force and its last position even if power is removed.

Note: The valve stem can be positioned manually by turning the manual adjustment knob shown in Figure 2. Rotating the knob counterclockwise moves the valve stem up.

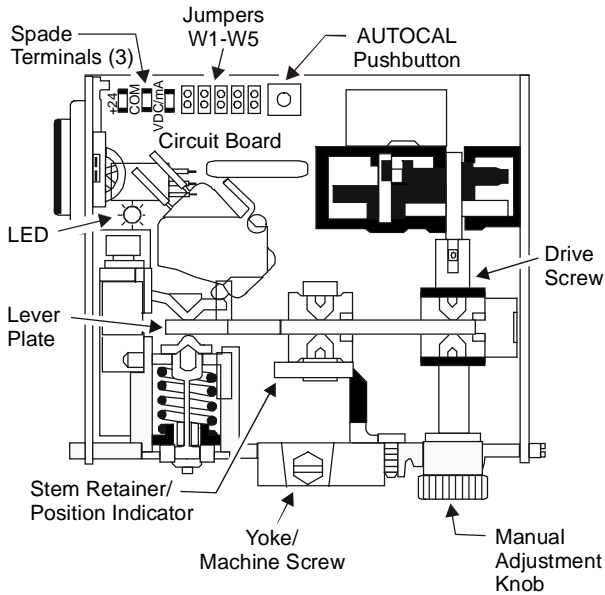

Figure 2: VA-8122 Components

IMPORTANT: There are no internal mechanical stops in the actuator. Never drive the actuator unless it is installed on the proper valve body, or the actuator may be damaged.

Dimensions

See Figure 3 for actuator dimensions.

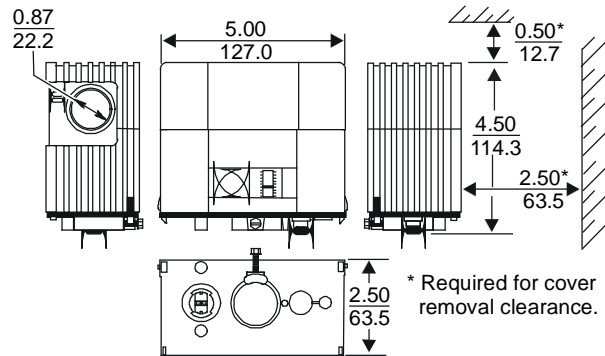

Figure 3: VA-8122 Dimensions, in. (mm)

Installation

IMPORTANT: Dripping water must be prevented from entering the actuator housing, since this could damage the actuator. Do not cover the actuator with thermal insulating material.

Note: The VA-8020-100 kit (ordered separately) is required if mounting to a VT Series Terminal Unit Valve.

Kit Includes

- VA-8122 actuator
- VA-8020-605 stem retainer and clip kit

Tools Required

- 5/16 in. (8 mm) nut driver or 3/16 in. (5 mm) flat-blade screwdriver
- needle-nose pliers
- crescent wrench (to fit 1-1/4 in. bonnet adaptor nut)

Mounting

IMPORTANT: Do not use on valves having a stroke over 5/16 in. Travel beyond 5/16 in. will damage the actuator or prevent complete shutoff.

Note: In horizontal piping applications, it is recommended that the valve be mounted within 85° of the upright position. When mounted in vertical piping, the valve must be protected from moisture.

Unpack the actuator and proceed as follows:

1. Remove the actuator cover by pressing inward on the plastic tabs while sliding the cover up and forward.
2. Make sure that the lever plate is within 1/4 in. (6.4 mm) of the upper stop. (See Figure 4.)

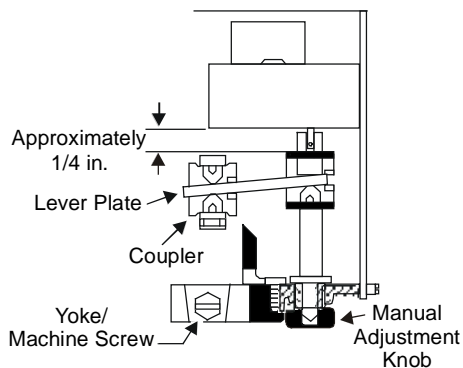

Figure 4: Plate Position

3. For VT valves, thread the bonnet adaptor nut (included in the VA-8020-100 kit) onto the valve bonnet shown in Figure 5, and tighten with a wrench until it is snug.

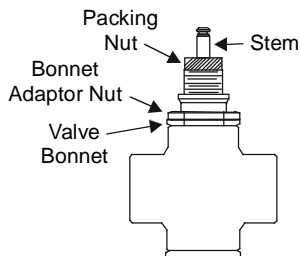

Figure 5: Valve Bonnet Adaptor

4. Position the actuator yoke on the bonnet adaptor nut, making sure the yoke is flush with the surface of the nut.

Note: If the valve stem is touching the coupler and preventing a flush contact, use the manual adjustment knob (shown in Figure 4) to reposition the coupler.

5. Secure the actuator to the valve bonnet by tightening the hex-head machine screw provided.
6. Place the stem retainer and coupling clip over the valve stem, so the lower (shorter) portion of the coupling clip is positioned in the locking groove on the valve stem as shown in Figure 6.

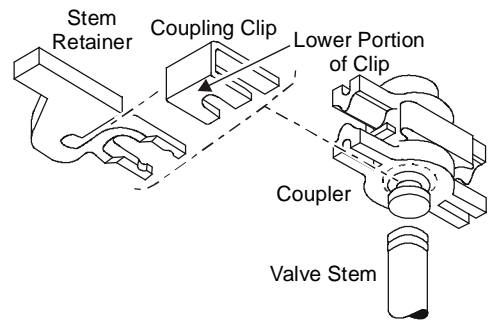

Figure 6: VA-8020-605 Stem Retainer and Clip Kit

Note: The extended portion of the stem retainer must be located on the right so that it lines up in the window of the cover. It may be necessary to pull the valve stem up to meet the coupler or to rotate the manual adjustment knob (shown in Figure 4) clockwise to run the coupler down.

7. Push the white plastic stem retainer until the coupling clip moves forward into the groove, and the retainer locks the clip in place.
8. Verify that the valve stem is located at the back of the groove by examining the connection.

To remove the coupling clip, use pliers to grip the stem retainer and pull outward. (See Figure 6.)





Calibration

The actuator drives in proportion to the amount of change in the input control signal. It accepts the input control signal ranges by means of jumpers. Electrical connections for the control input are made via spade terminals that are mounted on the circuit board located under the actuator's cover. (See Figure 2 for the location of the calibration components.)

Jumpers

The type of input control signal is determined by the position of Jumper W1. When Jumper W1 is in the VDC position (factory setting), the input signal is DC voltage. When Jumper W1 is in the mA position, the signal changes to current input. The direction of action, either DD (factory setting) or DU, is selected with Jumper W2. The range of the input signal is determined by the position of Jumpers W3, W4, and W5. (See Table 1 and Table 2.)

Table 1: Jumper Settings

Shown in Factory (Default) Settings				
W1	W2	W3	W4	W5*
(Current Input) mA 	(Drive Up) DU 	2-10 VDC (4-20 mA) 	0-20 VDC 	6-9 VDC 
VDC (Voltage Input)	DD (Drive Down)	0-10 VDC (0-20 mA)	0-10 VDC	—

* The 6-9 VDC position of Jumper W5 overrides Jumper W3.

Table 2: Available Input Control Signal vs. Input Jumpers

Control Signal	Jumper W1		Jumper W3		Jumper W4		Jumper W5*	
	VDC	mA	0-10	2-10	0-10	0-20	—	6-9
0 to 10 VDC	X		X		X		X	
2 to 10 VDC	X			X	X		X	
6 to 9 VDC	X		X		X			X
12 to 18 VDC	X		X			X		X
0 to 20 VDC	X		X			X	X	
4 to 20 VDC	X			X		X	X	
0 to 20 mA		X	X		X		X	
4 to 20 mA		X		X	X		X	

* When Jumper W5 is in the 6 to 9 VDC position, it overrides Jumper W3.

Table 3: Calibration Values for the AV-8122

Control Signal	Values (All Nominal)
0 to 10 VDC	0.7 to 9.3 VDC
2 to 10 VDC	2.6 to 9.4 VDC
6 to 9 VDC	6.5 to 8.5 VDC
0 to 20 VDC	1.4 to 18.6 VDC
4 to 20 VDC	5.2 to 18.8 VDC
0 to 20 mA	1.4 to 18.6 mA
4 to 20 mA	5.2 to 18.8 mA

Direction of Action

The actuator's direction of action is selected with Jumper W2. (See Figure 3.) The action of the actuator can be reversed by moving Jumper W2 on the circuit board. When Jumper W2 is in the DD position (factory setting), a low control input signal will cause the actuator lever arm to move to the highest position (valve stem up). A high control input signal will cause the actuator lever arm to move to the lowest position (valve stem down). When Jumper W2 is in the DU position, the lever arm will be low for a low control input signal and high for a high control input signal. (See Figure 7.)

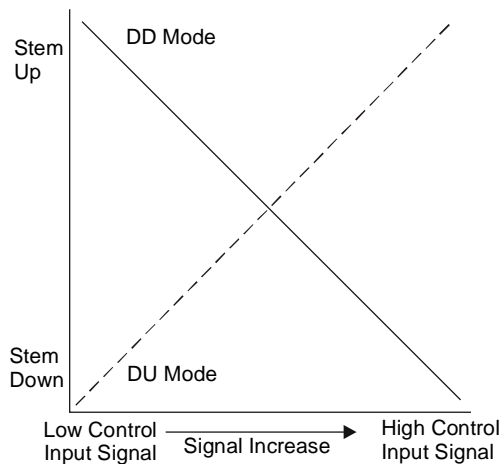

Figure 7: DD/DU Direction

The DD mode will result in the Direct Acting (DA) operation of a Push-Down-To-Open (PDTO) valve.

Auto Calibration

The VA-8122 is factory calibrated for a 5/16 in. valve stroke. To compensate for minor variations in strokes, use the Auto Calibration or AUTOCAL mode during the calibration and installation of the actuator. This mode allows the actuator to define the control input range proportionally over the valve stroke stored in nonvolatile memory (retains data when power is lost or removed).

Note: Once calibrated, it is not necessary to recalibrate if a jumper is changed.

To activate the AUTOCAL mode, depress the AUTOCAL pushbutton for approximately 3 seconds until the LED turns off. The actuator drives to the DU end-stop, then to the DD end-stop, and stores these positions in nonvolatile memory. The actuator will drive to the setpoint determined by the control signal applied after going through AUTOCAL.

Note: AUTOCAL mode only occurs when the pushbutton is depressed. It does not occur automatically when power is supplied to the actuator.

LED

The VA-8122 has a green LED display to indicate the actuator's operating mode. (See Table 4.)

Table 4: Operating Display

LED Indication	Description
On Solid	☀ Power is applied; actuator is at setpoint or stalled (not driving).
Single Blinking	☀ Power is applied; actuator is driving down or up.
Fast Single Blinking	☀ Insufficient supply voltage
Double Blinking	☀ Actuator is driving during the Auto Calibration mode (AUTOCAL pushbutton released).
Off	● Power is not applied or Auto Calibration mode is initiated (AUTOCAL pushbutton depressed for 3 seconds).

Wiring



CAUTION: Risk of Electric Shock.

Disconnect the power supply before making electrical connections to avoid electric shock.

MISE EN GARDE : Risque de décharge électrique.

Débrancher l'alimentation avant de réaliser tout raccordement électrique afin d'éviter tout risque de décharge électrique.



CAUTION: Risk of Property Damage.

Do not apply power to the system before checking all wiring connections. Short circuited or improperly connected wires may result in permanent damage to the equipment.

MISE EN GARDE : Risque de dégâts matériels.

Ne pas mettre le système sous tension avant d'avoir vérifié tous les raccords de câblage. Des fils formant un court-circuit ou connectés de façon incorrecte risquent d'endommager irrémédiablement l'équipement.

IMPORTANT: Make all wiring connections in accordance with the National Electrical Code and local regulations.

When a 24 VAC power signal is applied to the +24 and COM terminals, the VA-8122 accepts a DC voltage input control signal or current input signal at the VDC/mA (+) and COM (-) terminals.

The VA-8122 wiring connections are made to the tab receptacles shown in Figure 8. Use either the quick-connect terminals shown in Figure 9 or an M9000-105 Pluggable (3-position) Terminal Block.

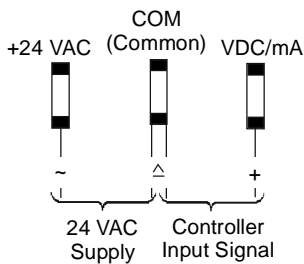

Figure 8: VA-8122 Wiring

IMPORTANT: Install all the quick-connect terminals in the same direction to each other to prevent the terminals from shorting. (See Figure 9.)



Figure 9: Orientation of Terminals

Input lines to the actuator must be wired correctly for the valve to move in the proper direction. (Refer to the specific controller wiring instructions as needed.) Wire the actuator as follows:

1. Push in the two tabs on the side of the actuator cover and lift and remove it.
2. Insert the controller leads through the plate on the side of the actuator.
3. Make the wiring connections to the terminals as shown in Figure 8.

Commissioning

Field calibration of the force sensor is not required.

If power is removed from the VA-8122, the valve stem remains in its intermediate position until power is reapplied.

If the control signal to the actuator is lost, the valve stem moves to the zero input signal position: valve stem up in DD mode or down in DU mode.

Checkout

The VA-8122 is factory set as follows:

- Jumper W1 in the VDC position
- Jumper W2 in the DD position
- Jumpers W3 and W4 in the 0 to 10 VDC position
- Jumper W5 in the "—" position

If this is the intended operation, proceed as follows:

1. Depress the AUTOCAL pushbutton. (Actuator drives to the DU end-stop, the DD end-stop, and then returns to the setpoint.)
2. Provide minimum control signal. (Actuator drives the valve stem up, and the motor stops.)

3. Provide maximum control signal. (Actuator drives the valve stem down, and the motor stops.)
4. Observe the vertical movement of the indicator within the actuator window to ensure proper positioning. The installation is complete.

Note: If factory settings are to be changed, see the *Calibration* section.

Ordering Information

Field repairs must not be made. To order a proportional valve actuator, contact the nearest Johnson Controls representative and specify product code number VA-8122-1.

Actuator Combinations

The VA-8122-1 is available factory coupled to 1/2 in. or 3/4 in. VG7000 Series bronze valves. The VA-8122 is also available for retrofitting VG7000 Series bronze valves, VT Series Terminal Unit Valves (with slotted stems), and VB-5x39 Series Flare Valves. Refer to the *AV-8122 Series Proportional Control Actuated Valve Product/Technical Bulletin (FAN 977 or 1628.3)*, and the *VG7000 Series Bronze Valves ANSI Class 250 (PN16) Body Size 1/2 through 2 inch (DN15 to DN50) Product/Technical Bulletin (FAN 977, 125, or 1628.3)* for available configurations. Accessories for the VA-8122 can be found in Table 5.

Table 5: Accessories

Product Code Number	Description
VA-8020-100	Mounting kit for VT Series valves
VA-8020-601	Replacement cover only
VA-8020-605*	Stem retainer and clip kit
M9000-105	Pluggable 3-position terminal block

* One kit is included with the actuator. If ordered separately, it must be ordered in multiples of five.

Specifications

Product	VA-8122 Proportional Valve Actuator
Power Requirements	24 VAC at 50/60 Hz, 5.0 VA supply minimum, Class 2
Input Signal	Jumper Selectable: 0 (2) to 10 VDC, 0 (4) to 20 VDC, 6 (12) to 9 (18) VDC, 0 (4) to 20 mA Factory Setting: 0 to 10 VDC, Drive Down (DD) action on signal increase
Input Impedance	Voltage Input: 0 to 10 VDC, 150,000 ohms and 0 to 20 VDC, 450,000 ohms Current Input: 0 to 20 mA, 500 ohms
5/16 in. Stroke Time	50 Hz: Approximately 108 seconds nominal 60 Hz: Approximately 90 seconds nominal
Force	Shutoff and Breakaway: 22 lb (98 N) minimum
Cycles	60,000 full cycles; 1,500,000 repositions
Enclosure	NEMA 1, IP20
Audible Noise Rating	35 dBA maximum at 3.28 ft (1 m)
Ambient Operating Conditions	35 to 135°F (2 to 57°C); 85°F (30°C) maximum dew point at 90% RH, non-condensing
Ambient Storage Conditions	-40 to 150°F (-40 to 65°C); 85°F (30°C) maximum dew point at 90% RH, non-condensing
Valve Media Temperature	Water: 195°F (90°C) maximum Steam: Actuator is not rated for this application.
Dimensions (H x W x D)	4.5 x 5.0 x 2.5 in. (114 x 127 x 64 mm)
Shipping Weight	1.6 lb (0.74 kg)
Agency Compliance	UL 873 Recognized, File E27734, Guide XAPX2 CSA C22.2 No. 139 Certified, File LR85083, Class 3221 02

The performance specifications are nominal and conform to acceptable industry standards. For application at conditions beyond these specifications, consult the local Johnson Controls office. Johnson Controls, Inc. shall not be liable for damages resulting from misapplication or misuse of its products.

European Single Point of Contact:

JOHNSON CONTROLS
WESTENDHOF 3
45143 ESSEN
GERMANY

NA/SA Single Point of Contact:

JOHNSON CONTROLS
507 E MICHIGAN ST
MILWAUKEE WI 53202
USA

APAC Single Point of Contact:

JOHNSON CONTROLS
C/O CONTROLS PRODUCT MANAGEMENT
NO. 22 BLOCK D NEW DISTRICT
WUXI JIANGSU PROVINCE 214142
CHINA



Building Efficiency
507 E. Michigan Street, Milwaukee, WI 53202

Metasys® and Johnson Controls® are registered trademarks of Johnson Controls, Inc. All other marks herein are the marks of their respective owners. © 2016 Johnson Controls, Inc.