

Section 23

Relays and Timers



General Purpose Relays 23-2

Zelio™ RSL Interface Relays	23-2
Zelio™ RSB Interface Relays	23-3
Zelio™ RXG Interface Relays	23-4
Zelio™ RXM Plug-In Relays	23-6
Sockets and Accessories for Zelio™ RXM Relays	23-8
Zelio™ RPM Plug-In Relays	23-9
Sockets and Accessories for Zelio™ RPM Relays	23-10
Zelio™ RUM Plug-In Relays	23-11
Sockets and Accessories for Zelio™ RUM Relays	23-12
Zelio™ RPF Power Relays	23-13
Square D™ Universal Relays	23-14
Square D™ Plug-in Relays	23-16
Square D™ Miniature Control Relays	23-17
Square D™ Power Relays	23-19

Industrial Relays 23-20

TeSys™ D IEC Style Instantaneous Control Relays	23-20
TeSys™ D IEC Style Contact Blocks and Accessories	23-21
TeSys™ K IEC Style Control Relays	23-23
TeSys™ K IEC Style Contact Blocks and Accessories	23-25
TeSys™ SK IEC Style Control Relays	23-26
Square D™ NEMA Style AC Relays	23-27
Square D™ NEMA Style DC Relays	23-29
Attachments and Accessories for Square D™ NEMA Style Relays	23-31

Solid State Relays 23-33

Zelio™ SSL Relays	23-33
Zelio™ SSM Relays	23-34
Zelio™ SSRP and SSRD Relays	23-36
Zelio™ SSP Relays	23-37

Timers 23-39

Zelio™ RE17 Modular Timers	23-39
Zelio™ RE48 Panel Mount Timers	23-40
Zelio™ REXL Miniature Plug-In Timers	23-41
Square D™ JCK General Purpose Plug-In Timers	23-42

Control and Measurement Relays 23-44

Zelio™ RTC48 Temperature Controllers	23-44
Zelio™ REG Temperature Controllers	23-45
Zelio™ Current Measurement Relays	23-47
Zelio™ Phase Measurement Relays	23-48
Zelio™ Voltage Measurement Relays	23-49
Zelio™ Level Control Relays and Zelio™ Pump Control Relays	23-50
Zelio™ Speed Control Relays, Frequency Control Relays, and Temperature Control Relays	23-52

Power Supplies 23-53

Phaseo™ DC Power Supply	23-53
-------------------------	-------

Interface Modules 23-54

Zelio™ Analog Interface Modules	23-54
Solid State Interface Modules	23-55
Electromechanical Interface Modules	23-56



RSL 1PV**



RSL 1PR**



RSL 1AB**



RSL ZVA*



RSL ZRA*



RSL Z2



RSL Z3

Zelio™ RSL Interface Relays

Zelio RSL slim interface relays save valuable panel space with a 6 mm width and have a 6 A general purpose load rating. Features include:

- Pre-assembled option: relay and socket are combined into one catalog number.
- Universal AC/DC sockets have built-in protection from transients and reverse polarity voltages (see catalog DIA3ED2090304EN-US for more detailed information).
- Accessories, which include isolators, ID tags, and bus jumper save valuable installation time.
- SPDT (1 C/O) design

Refer to [Online Relay Configurator](#).

Table 23.1: Pre-assembled Relay and Socket Combination (sold in lots of 10)

Socket Supply Voltage	Pre-Assembled Catalog Number ^[1]		Replacement Relays Catalog Number
	Screw Connector	Spring Terminal	
12 Vac/Vdc	RSL1PVJU	RSL1PRJU	RSL1AB4JD
24 Vac/Vdc	RSL1PVBU	RSL1PRBU	RSL1AB4BD
48 Vac/Vdc	RSL1PVEU	RSL1PREU	RSL1AB4ED
110 Vac/Vdc	RSL1PVFU	RSL1PRFU	RSL1AB4ND
230 Vdc	RSL1PVPU	RSL1PRPU	RSL1AB4ND

Table 23.2: Relays (sold in lots of 10)

Relay Coil Voltage ^[2]	Catalog Number
12 Vdc	RSL1AB4JD
24 Vdc	RSL1AB4BD
48 Vdc	RSL1AB4ED
60 Vdc	RSL1AB4ND

Table 23.3: Sockets (sold in lots of 10)

Control Voltage	Socket Type		For Use with Relays:
	Screw Connector Catalog Number	Spring Terminal Catalog Number	
12 Vac/Vdc	RSLZVA1	RSLZRA1	RSL1AB4JD
24 Vac/Vdc			RSL1AB4BD
48 Vac/Vdc	RSLZVA2	RSLZRA2	RSL1AB4ED
60 Vac/Vdc			RSL1AB4ND
110 Vac/Vdc	RSLZVA3	RSLZRA3	RSL1AB4ND
230 Vac/Vdc			RSL1AB4ND

Table 23.4: Accessories

Description	Compatibility	Catalog Number
ID tags (2 sheets of 64 tags)	With all RSL and SSL series sockets	RSLZ5
Bus jumper (10 x 20-pole jumpers)		RSLZ2
Butterfly isolator (10 isolators)		RSLZ3

Approvals for RSL Relays



File:
E173076
CCN:
NRNT2,
NRNT8



File:
240278
Class:
3211 04



IEC 61810-1

RoHS Compliant

Approvals for RSLZ Sockets



File:
E172326
CCN:
SWIV2,
SWIV8



File:
254977
Class:
3211 07



IEC 61984

RoHS Compliant

[1] Relays are mounted on sockets equipped with LED and protection circuit.

[2] The RSL sockets will accept an AC or DC input voltage; however, the relay always receives a filtered DC voltage.

Zelio™ RSB Interface Relays

Zelio RSB interface relays and sockets provide the optimum combination of robust performance and space saving for the most demanding applications. Relays are rated at 8 A, 12 A, and 16 A (250 Vac / 28 Vdc). Features include:

- Optional protection modules for protection against electrical transients
- Optional plastic hold-down ejector clips
- Socket or printed circuit board installation options

Refer to [Online Relay Configurator](#).



RSB1A160F7



RSB2A080BD



RSZE1S48M



RSB1A120JD Relay
+ RZM031FPD Socket
+ RSZE1S35M Module



RSB1A160BD Relay
+ RSZE1S48M Socket

Table 23.5: Relays (sold in lots of 10)

Coil Voltage	Number and type of contacts - Thermal current (Ith)		
	SPDT (1 C/O) -12 A Res.	SPDT (1 C/O) -16 A Res.	DPDT (2 C/O) -8 A Res.
	Catalog Number ^[3]	Catalog Number ^[3]	Catalog Number ^[3]
6 Vdc	RSB1A120RD	RSB1A160RD	RSB2A080RD
12 Vdc	RSB1A120JD	RSB1A160JD	RSB2A080JD
24 Vdc	RSB1A120BD	RSB1A160BD	RSB2A080BD
48 Vdc	RSB1A120ED	RSB1A160ED	RSB2A080ED
60 Vdc	RSB1A120ND	RSB1A160ND	RSB2A080ND
110 Vdc	RSB1A120FD	RSB1A160FD	RSB2A080FD
24 Vac	RSB1A120B7	RSB1A160B7	RSB2A080B7
48 Vac	RSB1A120E7	RSB1A160E7	RSB2A080E7
120 Vac	RSB1A120F7	RSB1A160F7	RSB2A080F7
220 Vac	RSB1A120M7	RSB1A160M7	RSB2A080M7
230 Vac	RSB1A120P7	RSB1A160P7	RSB2A080P7
240 Vac	RSB1A120U7	RSB1A160U7	RSB2A080U7

Table 23.6: Sockets – 12 A, 300 Vac (sold in lots of 10)

Contact Terminal Arrangement	Connection	For Use with Relays	Catalog Number
Separate ^[4]	Box lug connector	RSB1A120**	RSZE1S35M
		RSB1A160** ^[5]	RSZE1S48M
		RSB2A080**	

Table 23.7: Protection Modules (sold in lots of 10)

Description	Compatibility	Voltage	Catalog Number
Diode	RSZ***** sockets (RSB series), RGZ***** sockets (RXG series)	6–230 Vdc	RZM040W
RC circuit		24–60 Vac	RZM041BN7
		110–240 Vac	RZM041FU7
Diode + green LED		6–24 Vdc	RZM031RB
		24–60 Vdc	RZM031BN
		110–230 Vdc	RZM031FPD
Varistor + green LED		6–24 Vac/Vdc	RZM021RB
		24–60 Vac/Vdc	RZM021BN
		110–230 Vac/Vdc	RZM021FP

Table 23.8: Accessories (sold in lots of 10)

Description	Compatibility	Catalog Number
Plastic hold-down ejector clip	RSZ***** sockets (RSB series)	RSZR215
ID tags		RSZL300

Approvals for RSB Relays



File: E173076
CCN: NRNT2,
NRNT8



File: 215736
Class: 3211 07



IEC
61810-1

RoHS Compliant

Approvals for RSZ Sockets



File: E173076
CCN: NRNT2,
NRNT8



File: 254977
Class: 3211 07



IEC
61810-1

RoHS Compliant

- RZM modules are RoHS compliant.
- For mounting track, see [Mounting Track, End Clamps, Jumpers, Fanning Strips](#), page 24-19.

^[3] To order a relay complete with socket (sold in lots of 20): add suffix S to the catalog numbers selected above.
Example: RSB 2A080RD + RSZ E1S48M becomes RSB 2A080RDS.

^[4] The inputs and outputs are on separate sides.

^[5] When using the RSB1A160** relay with socket RSZ E1S48M, terminals 11 and 21, 14 and 24, 12 and 22 must be linked.

New!

Zelio™ RXG Interface Relays

The Zelio RXG interface relay range is comprised of 10 A relays with 1 C/O contact and 5 A relays with 2 C/O contacts all in the same optimal foot print. The mating sockets feature separate contact terminals with reliable screw connections that attach either to a convenient 35 mm DIN rail or flexible panel mounting. The entire offer is a complete system solution with protection modules (diode, diode + LED, RC circuit, or varistor + LED), plastic ejector/maintaining clip and ID Tags to identify relays.

- Standard hold-down ejector clip integrated with socket
- Optional protection modules for protection against electrical transients
- Industry standard footprint for seamless compatibility with competitive sockets
- UL Listed combination (Relay + Socket) for expedited system certification

Refer to [Online Relay Configurator](#).



RGZE1S35M Socket + RXG12BD Relay



RXG11RD



RXG22B7



RXG13RD



RXG15RD

Table 23.9: Relays: Standard Cover, without LED, with Test Button and Lock-Down Door (sold in lots of 10)

Coil Voltage	Number and type of contacts - Thermal current (Ith)	
	SPDT (1 C/O) - 10 A	DPDT (2 C/O) - 5 A
	Catalog Number	Catalog Number
6 Vdc	RXG11RD	RXG21RD
12 Vdc	RXG11JD	RXG21JD
24 Vdc	RXG11BD	RXG21BD
48 Vdc	RXG11ED	RXG21ED
60 Vdc	RXG11ND	RXG21ND
110 Vdc	RXG11FD	RXG21FD
24 Vac	RXG11B7	RXG21B7
48 Vac	RXG11E7	RXG21E7
120 Vac	RXG11F7	RXG21F7
220 Vac	RXG11M7	RXG21M7
230 Vac	RXG11P7	RXG21P7

Table 23.10: Relays: Standard Cover, with LED, with Test Button and Lock-Down Door (sold in lots of 10)

Coil Voltage	Number and type of contacts - Thermal current (Ith)	
	SPDT (1 C/O) - 10 A	DPDT (2 C/O) - 5 A
	Catalog Number	Catalog Number
6 Vdc	RXG12RD	RXG22RD
12 Vdc	RXG12JD	RXG22JD
24 Vdc	RXG12BD	RXG22BD
48 Vdc	RXG12ED	RXG22ED
60 Vdc	RXG12ND	RXG22ND
110 Vdc	RXG12FD	RXG22FD
24 Vac	RXG12B7	RXG22B7
48 Vac	RXG12E7	RXG22E7
120 Vac	RXG12F7	RXG22F7
220 Vac	RXG12M7	RXG22M7
230 Vac	RXG12P7	RXG22P7

Table 23.11: Relays: Standard Cover, with LED, without Test Button and Lock-Down Door (sold in lots of 10)

Coil Voltage	Number and type of contacts - Thermal current (Ith)	
	SPDT (1 C/O) - 10 A	DPDT (2 C/O) - 5 A
	Catalog Number	Catalog Number
6 Vdc	RXG13RD	RXG23RD
12 Vdc	RXG13JD	RXG23JD
24 Vdc	RXG13BD	RXG23BD
48 Vdc	RXG13ED	RXG23ED
60 Vdc	RXG13ND	RXG23ND
110 Vdc	RXG13FD	RXG23FD
24 Vac	RXG13B7	RXG23B7
48 Vac	RXG13E7	RXG23E7
120 Vac	RXG13F7	RXG23F7
220 Vac	RXG13M7	RXG23M7
230 Vac	RXG13P7	RXG23P7

Table 23.12: Relays: Clear Cover, without LED, without Test Button and Lock-Down Door (sold in lots of 10)

Coil Voltage	Number and type of contacts - Thermal current (Ith)	
	SPDT (1 C/O) - 10 A	DPDT (2 C/O) - 5 A
	Catalog Number	Catalog Number
6 Vdc	RXG15RD	RXG25RD
12 Vdc	RXG15JD	RXG25JD
24 Vdc	RXG15BD	RXG25BD
48 Vdc	RXG15ED	RXG25ED
60 Vdc	RXG15ND	RXG25ND
110 Vdc	RXG15FD	RXG25FD
24 Vac	RXG15B7	RXG25B7
48 Vac	RXG15E7	RXG25E7
120 Vac	RXG15F7	RXG25F7
220 Vac	RXG15M7	RXG25M7
230 Vac	RXG15P7	RXG25P7



RGZE1S48M



RZM031RB



RSZL300

Table 23.13: Sockets (sold in lots of 10)

Contact Terminal Arrangement	Connection	For Use with Relays	Catalog Number
Separate ^[6]	Box lug connector	RXG1***	RGZE1S35M^[7]
		RXG2***	RGZE1S48M^[7]

Table 23.14: Protection Modules (sold in lots of 10)

Description	Voltage	Compatibility	Catalog Number
Diode	6 to 230 Vdc 24 to 60 Vac	RSZ***** sockets (RSB series), RGZ***** sockets (RXG series)	RZM040W
RC circuit	110 to 240 Vac		RZM041BN7
	6 to 24 Vdc		RZM041FU7
Diode + green LED	24 to 60 Vdc 110 to 230 Vdc		RZM031RB
	6 to 24 Vdc/Vac		RZM031BN
Varistor + green LED	24 to 60 Vdc/Vac		RZM031FPD
	110 to 230 Vdc/Vac		RZM021RB
			RZM021BN
			RZM021FP

Table 23.15: Accessories (sold in lots of 10)

Description	For Use With	Catalog Number
Plastic ejector clip	RXG series (RSZ***** sockets)	RGZR215
Socket ID tags		RSZL300
Relay ID tags	RXG series relays	RGZL520

Approvals for RXG Relays



File: E173076
CCN: NRNT,
NRNT7^[8]



File: E173076
CCN:
NRNT2,
NRNT8



File: 254977
Class: 3211 07



RoHS Compliant

Approvals for RGZ Sockets



File: E172326
CCN: SW1V2,
SW1V8



File: 254977
Class: 3211 07



RoHS Compliant

[6] The inputs and outputs are on separate sides.
[7] Please note that RGZE1S35M and RGZE1S48M sockets come standard with the RGZR215 ejector clip
[8] When used with the appropriate RGZ socket.



RXZE2M114M Socket + RXM4AB2P7 Relay



RXM2AB1B7



RXM2AB2BD



RXM2AB3F7

Zelio™ RXM Plug-In Relays

Zelio RXM miniature plug-in relays and sockets provide a complete system solution in response to the most demanding applications ranging from 3 to 12 A. Some of the features include:

- Test button with removable lock-down door for testing the contacts (depending on model)
- Green LED indication of relay status (depending on model)
- Mechanical indication of relay status (standard)
- Optional protection modules to protect against electrical spikes
- Bus jumpers for connecting multiple terminals reduce installation time

Refer to [Online Relay Configurator](#).

Table 23.16: Relays: without LED, with Test button and Lock-Down Door (sold in lots of 10)

Coil Voltage	Number and type of contacts - Thermal current (Ith)		
	DPDT (2 C/O) -12 A Res.	3PDT (3 C/O) - 10 A Res.	4PDT (4 C/O) - 8 A Res.
	Catalog Number	Catalog Number	Catalog Number
12 Vdc	RXM2AB1JD	RXM3AB1JD	RXM4AB1JD
24 Vdc	RXM2AB1BD	RXM3AB1BD	RXM4AB1BD
48 Vdc	RXM2AB1ED	RXM3AB1ED	RXM4AB1ED
110 Vdc	RXM2AB1FD	RXM3AB1FD	RXM4AB1FD
220 Vdc	—	—	RXM4AB1MD
24 Vac	RXM2AB1B7	RXM3AB1B7	RXM4AB1B7
48 Vac	RXM2AB1E7	RXM3AB1E7	RXM4AB1E7
120 Vac	RXM2AB1F7	RXM3AB1F7	RXM4AB1F7
230 Vac	RXM2AB1P7	RXM3AB1P7	—
240 Vac	—	—	RXM4AB1U7

Table 23.17: Relays: with LED, with Test Button and Lock-Down Door (sold in lots of 10)

Coil Voltage	Number and type of contacts - Thermal current (Ith)		
	DPDT (2 C/O) -12 A Res.	3PDT (3 C/O) - 10 A Res.	4PDT (4 C/O) - 8 A Res.
	Catalog Number	Catalog Number	Catalog Number
12 Vdc	RXM2AB2JD	RXM3AB2JD	RXM4AB2JD
24 Vdc	RXM2AB2BD	RXM3AB2BD	RXM4AB2BD
48 Vdc	RXM2AB2ED	RXM3AB2ED	RXM4AB2ED
110 Vdc	RXM2AB2FD	RXM3AB2FD	RXM4AB2FD
125 Vdc	—	—	RXM4AB2GD
24 Vac	RXM2AB2B7	RXM3AB2B7	RXM4AB2B7
48 Vac	RXM2AB2E7	RXM3AB2E7	RXM4AB2E7
120 Vac	RXM2AB2F7	RXM3AB2F7	RXM4AB2F7
230 Vac	RXM2AB2P7	RXM3AB2P7	RXM4AB2P7

Table 23.18: Relays: with LED, without Test Button and Lock-Down Door (sold in lots of 10)

Coil Voltage	Number and type of contacts - Thermal current (Ith)		
	DPDT (2 C/O) -12 A Res.	3PDT (3 C/O) - 10 A Res.	4PDT (4 C/O) - 8 A Res.
	Catalog Number	Catalog Number	Catalog Number
12 Vdc	RXM2AB3JD	—	RXM4AB3JD
24 Vdc	RXM2AB3BD	—	RXM4AB3BD
48 Vdc	RXM2AB3ED	—	RXM4AB3ED
110 Vdc	RXM2AB3FD	—	RXM4AB3FD
125 Vdc	—	—	RXM4AB3GD
24 Vac	RXM2AB3B7	—	RXM4AB3B7
48 Vac	RXM2AB3E7	—	RXM4AB3E7
120 Vac	RXM2AB3F7	—	RXM4AB3F7
230 Vac	RXM2AB3P7	—	RXM4AB3P7

Table 23.19: Relays: Low level Contacts, without LED, with Test Button and Lock-Down Door (sold in lots of 10)

Coil Voltage	Number and type of contacts - Thermal current (Ith)
	4PDT (4 C/O) -3 A Res.
	Catalog Number
12 Vdc	RXM4GB1JD
24 Vdc	RXM4GB1BD
48 Vdc	RXM4GB1ED
110 Vdc	RXM4GB1FD
24 Vac	RXM4GB1B7
48 Vac	RXM4GB1E7
120 Vac	RXM4GB1F7
230 Vac	RXM4GB1P7

Table 23.20: Relays: Low Level Contacts, with LED, with Test button and Lock-Down Door (sold in lots of 10)

Coil Voltage	Number and type of contacts - Thermal current (Ith)	
	4PDT (4 C/O) - 3 A Res.	
	Catalog Number	
12 Vdc		RXM4GB2JD
24 Vdc		RXM4GB2BD
48 Vdc		RXM4GB2ED
110 Vdc		RXM4GB2FD
24 Vac		RXM4GB2B7
48 Vac		RXM4GB2E7
120 Vac		RXM4GB2F7
230 Vac		RXM4GB2P7
240 Vac		RXM4GB2U7



RXM4GB2F7

Table 23.21: Relays: Low Level Contacts, with LED, without Test Button and Lock-Down Door (sold in lots of 10)

Coil Voltage	Number and type of contacts - Thermal current (Ith)	
	4PDT (4 C/O) - 3 A Res.	
	Catalog Number	
12 Vdc		RXM4GB3JD
24 Vdc		RXM4GB3BD
48 Vdc		RXM4GB3ED
110 Vdc		RXM4GB3FD
125 Vdc		—
24 Vac		RXM4GB3B7
48 Vac		RXM4GB3E7
120 Vac		RXM4GB3F7
230 Vac		RXM4GB3P7

- For sockets and accessories, see [page 23-8](#).



RXZE2S108M



RXM040W



RXZ400

Sockets and Accessories for Zelio™ RXM Relays

Refer to [Online Relay Configurator](#).

Table 23.22: Sockets (sold in lots of 10)

Contact Terminal Arrangement	Connection	For Use with Relays	Catalog Number
Mixed ^[9]	Screw clamp terminals	RXM2**** ^[10] RXM4**** ^[10]	RXZE2M114 ^[11]
	Box lug connector	RXM2**** RXM4****	RXZE2M114M ^[11]
Separate ^[12]	Box lug connector	RXM2****	RXZE2S108M ^[13]
		RXM3****	RXZE2S111M ^[11]
		RXM4****	RXZE2S114M
	Spring Terminal	RXM2****	RXZE2S114S

Table 23.23: Protection Modules (sold in lots of 10)

Description	Voltage	Compatibility	Catalog Number
Diode	6–250 Vdc	RXZ**** sockets (RXM series), RPZF1 and RPZF2 sockets (RPM series)	RXM040W
RC circuit	24–60 Vac		RXM041BN7
	110–240 Vac		RXM041FU7
Varistor	6–24 Vac/Vdc		RXM021RB
	24–60 Vac/Vdc	RXM021BN	
	110–240 Vac/Vdc	RXM021FP	

Table 23.24: Accessories (sold in lots of 10)

Description	Compatibility	Catalog Number
Metal hold-down clip	RXZ sockets (RXM series)	RXZ400
Plastic hold-down ejector clip	RXZ sockets (RXM series)	RXZR335
Bus jumper, 2-pole (lth: 5 A max.)	RXZE2S sockets (RXM series)	RXZS2
DIN rail mounting adapter ^[14]	RXM series relays, RPM1 and RPM2 series relays	RXZE2DA
Panel mounting adapter ^[14]	RXM series relays, RPM1 and RPM2 series relays	RXZE2FA
Relay ID tags (sheet of 108 tags)	RXM series relays, RPM series relays, RUM series relays	RXZL520
Socket ID tags	RXZ sockets (RXM series, except RXZE2M114), RUZS sockets (RUM series)	RXZL420

Approvals for RXM Relays



File: E164862
CCN: NLDX,
NLDX7^[15]



File:
E164862
CCN:
NLDX2,
NLDX8



File:
230765
Class:
3211 07



RoHS
Compliant

Approvals for RXZ Sockets



File: E172326
CCN: SWIV2,
SWIV8



File: 230765
Class: 3211 07



RoHS
Compliant

[9] The inputs and outputs are mixed on both sides.
 [10] When mounting relay RXM2**** on socket RXZE2M****, the thermal current must not exceed 10 A.
 [11] Thermal current lth: 10 A
 [12] The inputs and outputs are on separate sides.
 [13] Thermal current lth: 12 A
 [14] Test button and lock-down door become inaccessible.
 [15] When used with the appropriate RXZ socket.

Zelio™ RPM Plug-In Relays

Zelio RPM plug-in relays and sockets provide a complete system solution for the most demanding applications up to 15 A. Some of the features include:

- Test button with removable lock-down door for testing the contacts (depending on model)
- Green LED indication of relay status (depending on model)
- Mechanical indication of relay status (standard)
- Optional modules to protect against electrical spikes

Refer to [Online Relay Configurator](#).



RPZF4 Socket
+RPM42P7 Relay



RPM13BD



RPM23P7



RPM33BD



RPM43BD

Table 23.25: Relays: without LED, with Test Button and Lock-Down Door (sold in lots of 10)

Coil Voltage	Number and type of contacts - Thermal current (Ith)			
	SPDT (1 C/O) - 15 A Res.	DPDT (2 C/O) - 15 A Res.	3PDT (3 C/O) - 15 A Res.	4PDT (4 C/O) - 15 A Res.
	Catalog Number	Catalog Number	Catalog Number	Catalog Number
12 Vdc	RPM11JD	RPM21JD	RPM31JD	RPM41JD
24 Vdc	RPM11BD	RPM21BD	RPM31BD	RPM41BD
48 Vdc	RPM11ED	RPM21ED	RPM31ED	RPM41ED
110 Vdc	RPM11FD	RPM21FD	RPM31FD	RPM41FD
24 Vac	RPM11B7	RPM21B7	RPM31B7	RPM41B7
48 Vac	RPM11E7	RPM21E7	RPM31E7	RPM41E7
120 Vac	RPM11F7	RPM21F7	RPM31F7	RPM41F7
230 Vac	RPM11P7	RPM21P7	RPM31P7	RPM41P7

Table 23.26: Relays: with LED, with Test Button and Lock-Down Door (sold in lots of 10)

Coil Voltage	Number and type of contacts - Thermal current (Ith)			
	SPDT (1 C/O) - 15 A Res.	DPDT (2 C/O) - 15 A Res.	3PDT (3 C/O) - 15 A Res.	4PDT (4 C/O) - 15 A Res.
	Catalog Number	Catalog Number	Catalog Number	Catalog Number
12 Vdc	RPM12JD	RPM22JD	RPM32JD	RPM42JD
24 Vdc	RPM12BD	RPM22BD	RPM32BD	RPM42BD
48 Vdc	RPM12ED	RPM22ED	RPM32ED	RPM42ED
110 Vdc	RPM12FD	RPM22FD	RPM32FD	RPM42FD
24 Vac	RPM12B7	RPM22B7	RPM32B7	RPM42B7
48 Vac	RPM12E7	RPM22E7	RPM32E7	RPM42E7
120 Vac	RPM12F7	RPM22F7	RPM32F7	RPM42F7
230 Vac	RPM12P7	RPM22P7	RPM32P7	RPM42P7

Table 23.27: Relays: with LED, without Test Button and Lock-Down Door (sold in lots of 10)

Coil Voltage	Number and type of contacts - Thermal current (Ith)			
	SPDT (1 C/O) - 15 A Res.	DPDT (2 C/O) - 15 A Res.	3PDT (3 C/O) - 15 A Res.	4PDT (4 C/O) - 15 A Res.
	Catalog Number	Catalog Number	Catalog Number	Catalog Number
12 Vdc	RPM13JD	RPM23JD	RPM33JD	RPM43JD
24 Vdc	RPM13BD	RPM23BD	RPM33BD	RPM43BD
48 Vdc	RPM13ED	RPM23ED	RPM33ED	RPM43ED
110 Vdc	RPM13FD	RPM23FD	RPM33FD	RPM43FD
125 Vdc	—	—	—	—
24 Vac	RPM13B7	RPM23B7	RPM33B7	RPM43B7
48 Vac	RPM13E7	RPM23E7	RPM33E7	RPM43E7
120 Vac	RPM13F7	RPM23F7	RPM33F7	RPM43F7
230 Vac	RPM13P7	RPM23P7	RPM33P7	RPM43P7

Sockets and Accessories for Zelio™ RPM Relays

Table 23.28: Sockets (sold in lots of 10)

Contact Terminal Arrangement	Connection	For Use with Relays	Catalog Number
Mixed ^[16]	Screw terminals	RPM1***	RPZF1
		RPM2***	RPZF2
		RPM3***	RPZF3
		RPM4***	RPZF4



RPZF2

Table 23.29: Protection Modules (sold in lots of 10)

Description	Voltage	Compatibility	Catalog Number
Diode	6–250 Vdc	RXZ sockets (RXM series) RPZF1, RPZF2	RXM040W
		RPZF3 RPZF4	RUW240BD
RC circuit	24–60 Vac	RXZ sockets (RXM series) RPZF1, RPZF2	RXM041BN7
	110–240 Vac		RXM041FU7
	110–240 Vac		RUW241P7
Varistor	6–24 Vac/Vdc	RXZ sockets (RXM series) RPZF1, RPZF2	RXM021RB
	24–60 Vac/Vdc		RXM021BN
	110–240 Vac/Vdc		RXM021FP
	24 Vac/Vdc		RUW242B7
	240 Vac/Vdc		RUW242P7



RXM041BN7

Table 23.30: Timer Module^[17] (sold in lots of 1)

Description	Voltage	Compatibility	Catalog Number
On-delay timer, interval timer, repeat cycle timer/starting on-delay, repeat cycle timer/starting off-delay, off-delay timer, one-shot timer, timing on de-energization, on-delay timer	24–240 Vac/Vdc	RPZF3 RPZF4	RUW101MW



RUW241P7



RUW101MW

Table 23.31: Accessories (sold in lots of 10)

Description	Compatibility	Catalog Number	
Metal hold-down clip (for single-pole relays)	RPZF1	RPZR235	
	RPM1***	RPZ1DA	
	RPM2***	RXZE2DA	
	RPM3***	RPZ3DA	
DIN rail mounting adapter ^[18]	RPM4***	RPZ4DA	
	Panel mounting adapter ^[19]	RPM1***	RPZ1FA
		RPM2***	RXZE2FA
		RPM3***	RPZ3FA
RPM4***		RPZ4FA	
ID tags (sheet of 108 tags)	RXM series relays, RPM series relays, RUM series relays	RXL520	



RPZ1DA



RPZ3FA

Approvals for RPM Relays



Approvals for RPZ Sockets

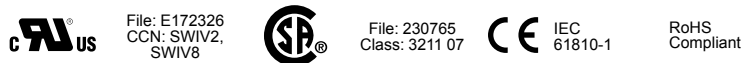

[16] The inputs and outputs are mixed on both sides.
 [17] See timer module description (selection of functions and time delays) in catalog DIA3ED2090304EN-US.
 [18] Test button and lock-down door become inaccessible
 [19] Test button and lock-down door become inaccessible
 [20] When used with the appropriate RPZ socket.

New!

Zelio™ RUM Plug-In Relays

Zelio RUM plug-in relays and sockets provide a complete system solution for the most demanding applications up to 10 A. Some of the features include:

- Test button with lock-down door for testing the contacts (depending on model)
- Green LED indication of relay status (depending on model)
- Mechanical indication of relay status (standard)
- Optional protection modules to protect against electrical spikes
- Bus jumpers for connecting multiple terminals reduce installation time.

Refer to [Online Relay Configurator](#).



RUZSF3M Socket + RUMF32BD Relay



RUMC31F7



RUMF22BD



RUMC23F7

Table 23.32: Relays: without LED, with Test Button, and Lock-Down Door (sold in lots of 10)

Pins	Coil Voltage	Number and type of contacts - Thermal current (Ith)	
		DPDT (2 C/O) -10 A Res.	3PDT (3 C/O) -10 A Res.
		Catalog Number	Catalog Number
Octal	12 Vdc	RUMC21JD	RUMC31JD
	24 Vdc	RUMC21BD	RUMC31BD
	48 Vdc	RUMC21ED	RUMC31ED
	60 Vdc	—	RUMC31ND
	110 Vdc	RUMC21FD	RUMC31FD
	125 Vdc	—	RUMC31GD
	220 Vdc	—	RUMC31MD
	24 Vac	RUMC21B7	RUMC31B7
	48 Vac	RUMC21E7	RUMC31E7
	120 Vac	RUMC21F7	RUMC31F7
Blade	230 Vac	RUMC21P7	RUMC31P7
	12 Vdc	RUMF21JD	RUMF31JD
	24 Vdc	RUMF21BD	RUMF31BD
	48 Vdc	RUMF21ED	RUMF31ED
	110 Vdc	RUMF21FD	RUMF31FD
	24 Vac	RUMF21B7	RUMF31B7
	48 Vac	RUMF21E7	RUMF31E7
	120 Vac	RUMF21F7	RUMF31F7
	230 Vac	RUMF21P7	RUMF31P7

Table 23.33: Relays: with LED, Test Button, and Lock-Down Door (sold in lots of 10)

Pins	Coil Voltage	Number and type of contacts - Thermal current (Ith)	
		DPDT (2 C/O) -10 A Res.	3PDT (3 C/O) -10 A Res.
		Catalog Number	Catalog Number
Octal	12 Vdc	RUMC22JD	RUMC32JD
	24 Vdc	RUMC22BD	RUMC32BD
	48 Vdc	RUMC22ED	RUMC32ED
	60 Vdc	—	RUMC32ND
	110 Vdc	RUMC22FD	RUMC32FD
	125 Vdc	—	RUMC32GD
	24 Vac	RUMC22B7	RUMC32B7
	48 Vac	RUMC22E7	RUMC32E7
	120 Vac	RUMC22F7	RUMC32F7
	230 Vac	RUMC22P7	RUMC32P7
Blade	12 Vdc	RUMF22JD	RUMF32JD
	24 Vdc	RUMF22BD	RUMF32BD
	48 Vdc	RUMF22ED	RUMF32ED
	110 Vdc	RUMF22FD	RUMF32FD
	24 Vac	RUMF22B7	RUMF32B7
	48 Vac	RUMF22E7	RUMF32E7
	120 Vac	RUMF22F7	RUMF32F7
	230 Vac	RUMF22P7	RUMF32P7

Table 23.34: Relays: with LED, without Push Button, and Lock-Down Door (sold in lots of 10)

Pins	Coil Voltage	Number and type of contacts - Thermal current (Ith)	
		DPDT (2 C/O) -10 A Res.	3PDT (3 C/O) -10 A Res.
		Catalog Number	Catalog Number
Octal	12 Vdc	RUMC23JD	RUMC33JD
	24 Vdc	RUMC23BD	RUMC33BD
	48 Vdc	RUMC23ED	RUMC33ED
	60 Vdc	—	RUMC33ND
	110 Vdc	RUMC23FD	RUMC33FD
	125 Vdc	—	RUMC33GD
	24 Vac	RUMC23B7	RUMC33B7
	48 Vac	RUMC23E7	RUMC33E7
	120 Vac	RUMC23F7	RUMC33F7
	230 Vac	RUMC23P7	RUMC33P7
Blade	12 Vdc	RUMF23JD	RUMF33JD
	24 Vdc	RUMF23BD	RUMF33BD
	48 Vdc	RUMF23ED	RUMF33ED
	110 Vdc	RUMF23FD	RUMF33FD
	125 Vdc	—	—
	24 Vac	RUMF23B7	RUMF33B7
	48 Vac	RUMF23E7	RUMF33E7
	120 Vac	RUMF23F7	RUMF33F7
	230 Vac	RUMF23P7	RUMF33P7

Sockets and Accessories for Zelio™ RUM Relays
Refer to [Online Relay Configurator](#).



RUC2M



RUW241P7



RUW101MW



RUZS2



RUC200

Table 23.35: Sockets (sold in lots of 10)

Contact Terminal Arrangement	Connection	For Use with Relays	Catalog Number
Mixed [21]	Box lug connector (screw terminals)	RUMC2****	RUZC2M
		RUMC3****	RUZC3M
		RUMC2****	RUZSC2M
RUMC3****		RUZSC3M	
Separate [22]		RUMF2****	RUZSF3M
		RUMF3****	

Table 23.36: Protection Modules (sold in lots of 10)

Description	Compatibility	Voltage	Catalog Number
Diode	RUZ... sockets (RUM series)	6–250 Vdc	RUW240BD
RC circuit		110–240 Vac	RUW241P7
Varistor		24 Vac/Vdc	RUW242B7
		240 Vac/Vdc	RUW242P7

Table 23.37: Timer Module [23] (sold in lots of 1)

Description	Compatibility	Voltage	Catalog Number
On-delay timer, interval timer, repeat cycle timer/starting on-delay, repeat cycle timer/starting off-delay, off-delay timer, one-shot timer, timing on de-energization, on-delay timer.	RUZ... sockets (RUM series)	24–240 Vac/Vdc	RUW101MW

Table 23.38: Accessories (sold in lots of 10)

Description	Compatibility	Catalog Number
Metal hold-down clip	RUZ sockets (RUM series)	RUZC200
Bus jumper, 2-pole (lth: 5 A)	RUZS sockets (RUM series)	RUZS2
Relay ID tags (sheet of 108 tags)	RXM series relays, RPM series relays, RUM series relays	RXZL520
Socket ID tags	RXZ sockets (RXM series, except RXZE2M114), RUZS sockets (RUM series).	RUZL420

Approvals for RUM Relays



Approvals for RUZ Sockets

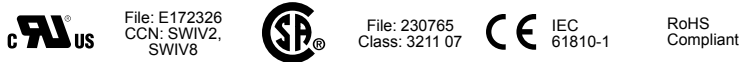

[21] The inputs and outputs are mixed on both sides.
 [22] The inputs and outputs are on separate sides.
 [23] See timer module description (selection of functions and time delays) in catalog DIA3ED2090304EN-RUM-US.
 [24] When used with the appropriate RUZ socket.



RPF2AP7



RPF2BBD

Zelio™ RPF Power Relays

Zelio RPF power relays respond to the most demanding applications up to 30 A. Features include:

- UL Listed
- Sealed construction
- Motor load ratings: 1 hp @ 120 Vac / 3 hp @ 240 Vac (N/O contacts only)
- DIN rail and panel mounting capability
- Short circuit rating of 5,000 A rms @ 3 hp, 240 Vac (N/O contacts only)

Refer to [Online Relay Configurator](#).

Table 23.39: Relays (sold in lots of 10)

Coil Voltage	Number and type of contacts - Thermal current (Ith)	
	DPST (2 N/O) - 30 A at 277 Vac, 20 A at 28 Vdc	DPDT (2 C/O) - 30 A at 277 Vac, 20 A at 28 Vdc, 3A (NC)
	Catalog Number	Catalog Number
12 Vdc	RPF2AJD	RPF2BJD
24 Vdc	RPF2ABD	RPF2BBD
24 Vac	RPF2AB7	RPF2BB7
120 Vac	RPF2AF7	RPF2BF7
230 Vac	RPF2AP7	RPF2BP7

Approvals for RPF Relays



File: E43641
CCN: NLDX, NLDX7



File: 040787
Class: 3211-07



IEC 61810-1
RoHS Compliant

- For mounting track (DIN rail), see [Mounting Track, End Clamps, Jumpers, Fanning Strips](#), page 24-19.

New!

Square D™ Universal Relays

8501K relays are designed for multipole switching applications at 240 Vac or lower. These relays have industry standard wiring and pin terminal arrangements which allow for their use as replacements for many competitive relays without wiring or hardware modifications.

- 10 A relays
- DPDT or 3PDT
- Green pilot light option
- Motor load (hp) ratings
- DPDT latching models available
- AC or DC operation
- RoHS Compliant



8501KPDR12V60



8501KFR13V20



8501KUDR12P14V60



8501NR61



8501NR52



8501NR82



8501NR52 Socket
+8501KPR13P14V2 Relay



8501NR82 Socket
+8501KUDR12P14V Relay

Table 23.40: Relays: Standard Cover, without LED

Pins	Coil Voltage	Number and Type of Contacts - Thermal current (Ith)	
		DPDT (2 C/O) - 10 A	3PDT (3 C/O) - 10 A
		Catalog Number	Catalog Number
Octal	12 Vdc	8501KPDR12V51	8501KPDR13V51
	24 Vdc	8501KPDR12V53	8501KPDR13V53
	48 Vdc	8501KPDR12V56	8501KPDR13V56
	110 Vdc	8501KPDR12V60	8501KPDR13V60
	24 Vac	8501KPR12V14	8501KPR13V14
	120 Vac	8501KPR12V20	8501KPR13V20
Blade	240 Vac	8501KPR12V24	8501KPR13V24
	12 Vdc	8501KUDR12V51	8501KUDR13V51
	24 Vdc	8501KUDR12V53	8501KUDR13V53
	48 Vdc	8501KUDR12V56	8501KUDR13V56
	110 Vdc	8501KUDR12V60	8501KUDR13V60
	24 Vac	8501KUR12V14	8501KUR13V14
	120 Vac	8501KUR12V20	8501KUR13V20
	240 Vac	8501KUR12V24	8501KUR13V24

Table 23.41: Relays: Flange Mount Cover

Pins	Coil Voltage	Number and Type of Contacts - Thermal current (Ith)	
		DPDT (2 C/O) - 10 A	3PDT (3 C/O) - 10 A
		Catalog Number	Catalog Number
Blade	12 Vdc	8501KFDR12V51	8501KFDR13V51
	24 Vdc	8501KFDR12V53	8501KFDR13V53
	48 Vdc	8501KFDR12V56	8501KFDR13V56
	110 Vdc	8501KFDR12V60	8501KFDR13V60
	24 Vac	8501KFR12V14	8501KFR13V14
	120 Vac	8501KFR12V20	8501KFR13V20
	240 Vac	8501KFR12V24	8501KFR13V24

Table 23.42: Relays: Standard Cover, with LED

Pins	Coil Voltage	Number and Type of Contacts - Thermal current (Ith)	
		DPDT (2 C/O) - 10 A	3PDT (3 C/O) - 10 A
		Catalog Number	Catalog Number
Octal	12 Vdc	8501KPDR12P14V51	8501KPDR13P14V51
	24 Vdc	8501KPDR12P14V53	8501KPDR13P14V53
	48 Vdc	8501KPDR12P14V56	8501KPDR13P14V56
	110 Vdc	8501KPDR12P14V60	8501KPDR13P14V60
	24 Vac	8501KPR12P14V14	8501KPR13P14V14
	120 Vac	8501KPR12P14V20	8501KPR13P14V20
Blade	240 Vac	8501KPR12P14V24	8501KPR13P14V24
	12 Vdc	8501KUDR12P14V51	8501KUDR13P14V51
	24 Vdc	8501KUDR12P14V53	8501KUDR13P14V53
	48 Vdc	8501KUDR12P14V56	8501KUDR13P14V56
	110 Vdc	8501KUDR12P14V60	8501KUDR13P14V60
	24 Vac	8501KUR12P14V14	8501KUR13P14V14
	120 Vac	8501KUR12P14V20	8501KUR13P14V20
	240 Vac	8501KUR12P14V24	8501KUR13P14V24

Table 23.43: Sockets

Contact Terminal Arrangement	Connection	For Use with Relays	Sold in Lots of	Catalog Number ^[1]
Mixed	Screw Connector	8501KPR12*** 8501KPDR12***	1	8501NR51
		8501KPR12*** 8501KPDR12***	10	8501NR51B
		8501KPR13*** 8501KPDR13***	1	8501NR61
		8501KPR13*** 8501KPDR13***	10	8501NR61B
		8501KPR12*** 8501KPDR12***	1	8501NR52
		8501KPR12*** 8501KPDR12***	10	8501NR52B
Separate	Screw Connector	8501KPR13*** 8501KPDR13***	1	8501NR62
		8501KPR13*** 8501KPDR13***	10	8501NR62B
		8501KUR12*** 8501KUDR12***	1	8501NR82
		8501KUR12*** 8501KUDR12***	10	8501NR82B
		8501KUR13*** 8501KUDR13***	1	8501NR82

[1] Please note that the B suffix only designates quantities of 10 and is not printed on the socket.

Table 23.43 Sockets (cont'd.)

Contact Terminal Arrangement	Connection	For Use with Relays	Sold in Lots of	Catalog Number ^[1]
		8501KUR13... 8501KUDR13...	10	8501NR82B

Table 23.44: Accessories (Sold in Lots of 10)

Description	For Use With	Sold in Lots of	Catalog Number
Metal Restraining Strap	8501NR51 sockets	1	8501NH7
	8501NR52 sockets		
	8501NR62 sockets		
	8501NR82 sockets		
Metal Hold-Down Clip	8501NR52 sockets	10	8501NH52
	8501NR62 sockets		8501NH82
	8501NR82 sockets		

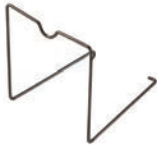

Approvals for 8501 KPR, KUR, and KFR Relays



File: E3190
CCN: NLDX,
NLDX7^[2]



File: E3190
CCN:
NLDX2,
NLDX8



File:
260367
Class:
3211 07



RoHS
Compliant

Approvals for 8501NR Sockets



File: E66924
CCN: SWIV2,
SWIV8



File: 211268
Class: 3211 07



RoHS
Compliant

^[1] Please note that the B suffix only designates quantities of 10 and is not printed on the socket.

^[2] When used with the appropriate 8501NR socket.



8501RS41P14V20



8501RSD42P14V51



8501RS43P14V20



8501RS44P14V20



8501NR41 Socket
+8501RS41P14V20 Relay



8501NR42 Socket
+8501RSD42P14V51 Relay



8501NR43 Socket
+8501RS43P14V20 Relay



8501NR34 Socket
+8501RS44P14V20 Relay

Square D™ Plug-in Relays

8501R miniature plug-in relays have a 15 A resistive rating. The compact size of these relays makes them ideal for downsizing equipment and applications where space is at a premium.

- SPDT through 4PDT
- AC or DC operated
- Horsepower rated
- Socket compatible
- Green LED pilot light option
- Silver alloy contacts

Table 23.45: Relays: Standard Cover, without LED

Coil Voltage	Number and Type of Contacts - Thermal current (lth)			
	SPDT (1 C/O) - 15 A	DPDT (2 C/O) - 15 A	3PDT (3 C/O) - 15 A	4PDT (4 C/O) - 15 A
	Catalog Number	Catalog Number	Catalog Number	Catalog Number
12 Vdc	8501RSD41V51	8501RSD42V51	8501RSD43V51	8501RSD44V51
24 Vdc	8501RSD41V53	8501RSD42V53	8501RSD43V53	8501RSD44V53
110 Vdc	8501RSD41V60	8501RSD42V60	8501RSD43V60	8501RSD44V60
12 Vac	8501RS41V36	8501RS42V36	8501RS43V36	8501RS44V36
24 Vac	8501RS41V14	8501RS42V14	8501RS43V14	8501RS44V14
120 Vac	8501RS41V20	8501RS42V20	8501RS43V20	8501RS44V20
240 Vac	8501RS41V24	8501RS42V24	8501RS43V24	8501RS44V24

Table 23.46: Relays: Standard Cover, with LED

Coil Voltage	Number and Type of Contacts - Thermal current (lth)			
	SPDT (1 C/O) - 15 A	DPDT (2 C/O) - 15 A	3PDT (3 C/O) - 15 A	4PDT (4 C/O) - 15 A
	Catalog Number	Catalog Number	Catalog Number	Catalog Number
12 Vdc	8501RSD41P14V51	8501RSD42P14V51	8501RSD43P14V51	8501RSD44P14V51
24 Vdc	8501RSD41P14V53	8501RSD42P14V53	8501RSD43P14V53	8501RSD44P14V53
110 Vdc	8501RSD41P14V60	8501RSD42P14V60	8501RSD43P14V60	8501RSD44P14V60
12 Vac	8501RS41P14V36	8501RS42P14V36	8501RS43P14V36	8501RS44P14V36
24 Vac	8501RS41P14V14	8501RS42P14V14	8501RS43P14V14	8501RS44P14V14
120 Vac	8501RS41P14V20	8501RS42P14V20	8501RS43P14V20	8501RS44P14V20
240 Vac	8501RS41P14V24	8501RS42P14V24	8501RS43P14V24	8501RS44P14V24

Table 23.47: Sockets

Contact Terminal Arrangement	Connection	For Use with Relays	Sold in Lots of	Catalog Number ^[3]
Separate ^[4]	Screw Connector	8501RS41***	1	8501NR41
		8501RSD41***	10	8501NR41B
		8501RS42***	1	8501NR42
		8501RSD42***	10	8501NR42B
		8501RS43***	1	8501NR43
		8501RSD43***	10	8501NR43B
		8501RS44***	1	8501NR34
		8501RSD44***	10	8501NR34B

Table 23.48: Accessories (Sold in Lots of 10)

Description	For Use With	Sold in Lots of	Catalog Number
Plastic ID Clip	8501NR41 socket	Supplied with socket	—
	8501NR42 socket		
Metal Hold-Down Clip	8501NR43 socket	10	8501NH42
	8501NR34 socket		

Approvals for 8501 RS41, RSD41, RS42, RSD42, RS43, RSD43, RS44, and RSD44



File: E3190
CCN: NLDX,
NLDX7^[5]



File: E3190
CCN:
NLDX2,
NLDX8



File:
260367
Class:
3211 07



RoHS
Compliant

Approvals for 8501NR Sockets



File: E66924
CCN: SWIV2,
SWIV8



File: 211268
Class: 3211 07



RoHS
Compliant

[3] Please note that the B suffix only designates quantities of 10 and is not printed on the socket.

[4] The inputs and outputs are on separate sides.

[5] When used with the appropriate 8501NR socket.

Square D™ Miniature Control Relays

8501R relays are suited for use as logic elements and power switching output devices. The short stroke motion of the armature provides long mechanical life required for high speed operation of control systems. Different contact compositions allow these relays to be used in a variety of applications. Bifurcated crossbar (gold overlay silver) is suitable for high contact reliability and low level switching requirements. Silver alloy is best suited for inductive loads. Class I Division II sealed relays can be used in specified hazardous locations.

- 4PDT
- Complete socket line
- Horsepower rated
- AC or DC operation
- Green pilot light option



8501NR45 Socket
+8501RS14V20 Relay



8501RS14V14



8501RSD24P14V60



8501RSD34V51

Table 23.49: Relays: Standard Cover, without LED

Coil Voltage	Number and Type of Contacts — Thermal current (Ith)	
	4PDT (4 C/O) — 6 A	4PDT (4 C/O) — 3 A
	Catalog Number	Catalog Number
12 Vdc	8501RSD14V51	8501RSD24V51
24 Vdc	8501RSD14V53	8501RSD24V53
48 Vdc	8501RSD14V56	8501RSD24V56
110 Vdc	8501RSD14V60	8501RSD24V60
24 Vac	8501RS14V14	8501RS24V14
120 Vac	8501RS14V20	8501RS24V20
240 Vac	8501RS14V24	8501RS24V24

Table 23.50: Relays: Standard Cover, with LED

Coil Voltage	Number and Type of Contacts — Thermal current (Ith)	
	4PDT (4 C/O) — 6 A	4PDT (4 C/O) — 3 A
	Catalog Number	Catalog Number
12 Vdc	8501RSD14P14V51	8501RSD24P14V51
24 Vdc	8501RSD14P14V53	8501RSD24P14V53
48 Vdc	8501RSD14P14V56	8501RSD24P14V56
110 Vdc	8501RSD14P14V60	8501RSD24P14V60
24 Vac	8501RS14P14V14	8501RS24P14V14
120 Vac	8501RS14P14V20	8501RS24P14V20
240 Vac	8501RS14P14V24	8501RS24P14V24

Table 23.51: Relays: Hermetically Sealed Miniature Control Relays

Coil Voltage	Number and Type of Contacts — Thermal current (Ith)	
	4PDT (4 C/O) — 5 A	
	Catalog Number	
6 Vdc	8501RSD34V50	
12 Vdc	8501RSD34V51	
24 Vdc	8501RSD34V53	
48 Vdc	8501RSD34V56	
110 Vdc	8501RSD34V60	
6 Vac	8501RS34V35	
12 Vac	8501RS34V36	
24 Vac	8501RS34V14	
48 Vac	8501RS34V17	
110 Vac	8501RS34V20	
240 Vac	8501RS34V24	



8501NR45



8501NH45

Table 23.52: Sockets

Contact Terminal Arrangement	Connection	For Use With Relays	Sold in Lots of	Catalog Number ^[6]
Separate ^[7]	Screw Clamp Terminals	8501RS(D)14*** 8501RS(D)24*** 8501RS(D)34***	1	8501NR45
		8501RS(D)14*** 8501RS(D)24*** 8501RS(D)34***	10	8501NR45B
		8501RS(D)14*** 8501RS(D)24*** 8501RS(D)34***	10	RXZE2S114S

Table 23.53: Accessories (Sold in Lots of)

Description	For Use With	Sold in Lots of	Catalog Number
Metal hold-down clip	8501NR45 socket	10	8501NH45
Clip-in ID tags	RXZE2S114S socket	10	RSZL300

Approvals for 8501 RS14, RSD14, RS24, and RSD24 Relays



File: E3190
CCN: NLDX,
NLDX7^[8]



File: E3190
CCN:
NLDX2,
NLDX8



File:
260367
Class:
3211 07



RoHS
Compliant

Approvals for 8501 RS34 and RSD34 Relays



File: E123950
CCN: NLDX,
NLDX7^[8]
ANSI/ISA
12.12.01



File:
E196809
CCN:
NQMJ2,
NQMJ8



File:
211268
Class:
3218 06



RoHS
Compliant

Approvals for 8501NR Sockets



File: E66924
CCN: SWIV2,
SWIV8



File: 211268
Class: 3211 07



RoHS
Compliant

[6] Please note that the B suffix only designates quantities of 10 and is not printed on the socket.

[7] The inputs and outputs are on separate sides.

[8] When used with the appropriate 8501NR socket.



8501CDO6V51

Square D™ Power Relays

8501C relays are ideally suited for controlling single-phase motors, electric heaters, pumps, conveyors, material handling equipment, and other applications.

- 40 A contact rating
- Motor load (hp) ratings
- Durable open-frame construction
- UL Listed
- CSA certified
- CE approved
- RoHS compliant

Table 23.54: Relays: AC Rated Contacts, 40 A at 277 V (sold in lots of 1)

Coil Voltage	Number and type of contacts - Thermal current (lth)				
	SPST: 1 NO / 0 NC	DPST: 2 NO / 0 NC	SPST: 0 NO / 1 NC	SPDT: 1 NO / 1 NC	DPDT: 2 NO / 2 NC
	Catalog Number	Catalog Number	Catalog Number	Catalog Number	Catalog Number
6 Vdc	8501CDO6V50	8501CDO7V50	8501CDO8V50	8501CDO15V50	8501CDO16V50
12 Vdc	8501CDO6V51	8501CDO7V51	8501CDO8V51	8501CDO15V51	8501CDO16V51
24 Vdc	8501CDO6V53	8501CDO7V53	8501CDO8V53	8501CDO15V53	8501CDO16V53
110 Vdc	8501CDO6V60	8501CDO7V60	8501CDO8V60	8501CDO15V60	8501CDO16V60
6 Vac	8501CO6V35	8501CO7V35	8501CO8V35	8501CO15V35	8501CO16V35
12 Vac	8501CO6V36	8501CO7V36	8501CO8V36	8501CO15V36	8501CO16V36
24 Vac	8501CO6V14	8501CO7V14	8501CO8V14	8501CO15V14	8501CO16V14
120 Vac	8501CO6V20	8501CO7V20	8501CO8V20	8501CO15V20	8501CO16V20
208 Vac	8501CO6V08	8501CO7V08	8501CO8V08	8501CO15V08	8501CO16V08
240 Vac	8501CO6V24	8501CO7V24	8501CO8V24	8501CO15V24	8501CO16V24
277 Vac	8501CO6V04	8501CO7V04	8501CO8V04	8501CO15V04	8501CO16V04
480 Vac	8501CO6V29	8501CO7V29	8501CO8V29	8501CO15V29	8501CO16V29

Table 23.55: Relays: DC Rated Contacts, 20 A at 110 V (sold in lots of 1)

Coil Voltage	Number and type of contacts - Thermal current (lth)
	SPST: 1 NO / 0 NC Catalog Number
6 Vdc	8501CDO21V50
12 Vdc	8501CDO21V51
24 Vdc	8501CDO21V53
110 Vdc	8501CDO21V60
6 Vac	8501CO21V35
12 Vac	8501CO21V36
24 Vac	8501CO21V14
120 Vac	8501CO21V20
208 Vac	8501CO21V08
240 Vac	8501CO21V24
277 Vac	8501CO21V04
480 Vac	8501CO21V29

Table 23.56: Relays: DC Rated Contacts, 10 A at 110 V (sold in lots of 1)

Coil Voltage	Number and type of contacts - Thermal current (lth)
	DPDT: 1 NO / 0 NC Catalog Number
6 Vdc	8501CDO22V50
12 Vdc	8501CDO22V51
24 Vdc	8501CDO22V53
110 Vdc	8501CDO22V60
6 Vac	8501CO22V35
12 Vac	8501CO22V36
24 Vac	8501CO22V14
120 Vac	8501CO22V20
208 Vac	8501CO21V08
240 Vac	8501CO22V24
277 Vac	8501CO22V04
480 Vac	8501CO22V29

Approvals for Square D Power Relays



File: E78351
CCN: NLDX,
NLDX7



File: 218139
Class: 3211 04



IEC 60947-4-1



CAD32

TeSys™ D IEC Style Instantaneous Control Relays

These 600 V relays are approved for use around the world. TeSys D relays are usually mounted on 35 mm DIN track, but can also be mounted directly to a panel. The contacts have NEMA A600 and Q600 ratings, in addition to the standard IEC ratings, making them suitable for use in most any control circuit. Low consumption versions are available for use with low level DC control signals from a computer or a PLC. Adder decks can be added to a basic five pole relay to make it up to an 11 pole relay. The serrated silver-nickel contacts with wiping action provide excellent reliability in 12 or 24 V control circuits. Special auxiliary contacts are available for switching low power down to 5 V at 10 mA. Timer and mechanical latch attachments are available.

Table 23.57: Instantaneous Control Relays

Terminal Type	Number of Contacts	Contact Composition		Catalog Number ^[1]
		Normally Open	Normally Closed	
Screw Clamp	5	5	0	CAD50
		3	2	CAD32
Spring Terminal	5	5	0	CAD503
		3	2	CAD323
Ring Tongue	5	5	0	CAD506
		3	2	CAD326

Table 23.58: Coil Voltage Codes:
12–240 Vac, 12–72 Vdc, 5–72 Vdc Low Consumption^[2]

AC 50/60 Hz Coil (for additional voltage code options see page 7 of Catalog 8501CT0101).						
Volts	12	24	48	120	208	240
Code	J7	B7	E7	G7	LE7	U7
DC Coil (coils have built in suppression as standard)						
Volts	12	24	36	48	60	72
Code	JD	BD	CD	ED	ND	SD
DC Low Consumption Coil (coils have built in suppression as standard)						
Volts	5	12	24	48	72	
Code	AL	JL	BL	EL	SL	

Table 23.59: Coil Voltage Codes (cont.):
277–600 Vac, 110–440 Vdc^[2]

AC 50/60 Hz Coil (for additional voltage code options see page 7 of Catalog 8501CT0101).					
Volts	277	480	600		
Code	W7	T7	X7		
DC Coil (coils have built in suppression as standard)					
Volts	110	125	220	250	440
Code	FD	GD	MD	UD	RD

Table 23.60: Instantaneous Auxiliary Contact Blocks (for use in normal operation environments)

Number of Contacts	Maximum Number per Device Clip-on Mounting		Termination Type	Contact Composition		Catalog Number
	Front	Left Side Only		Normally Open	Normally Closed	
2	1	—	Screw Clamp	2	0	LADN20
				1	1	LADN11
			0	2	LADN02	
	Spring Terminal	2	0	LADN203		
		1	1	LADN113		
		0	2	LADN023		
—	Not for DC devices	Screw Clamp	2	0	LAD8N20	
			1	1	LAD8N11	
			0	2	LAD8N02	
		Spring Terminal	4	0	LADN40	
			3	1	LADN31	
			2	2	LADN22	
4 ^[3]	1	—	Screw Clamp	1	3	LADN13
				0	4	LADN04
				4	0	LADN403
			Spring Terminal	3	1	LADN313
				2	2	LADN223
				1	3	LADN133
4 ^[3]	1	—	Screw Clamp	2 ^[4]	2 ^[4]	LADC22
			Spring Terminal	2 ^[4]	2 ^[4]	LADC223

Table 23.61: Instantaneous Auxiliary Contacts with Dust and Damp Protected Contacts (for use in harsh industrial environments)

Number of Contacts	Maximum Number per Device	Contact Composition					Catalog Number
		Sealed	[5]	Normal			
2	1	2	—	—	—	—	LA1DX20
		—	2	—	—	—	LA1DX02
		2	—	2	—	—	LA1DY20
4 ^[3]	1	2	—	—	2	—	LA1DZ40
		2	—	—	1	1	LA1DZ31

Approvals for TeSys D IEC Style Instantaneous Control Relays



File: E164353
CCN: NKCR



File: LR43364
Class: 3211 03



- For replacement AC coils, see [TeSys™ D and F Overload Relay Accessories, page 18-22](#). DC coils are not replaceable.

[1] Add the proper voltage code from [Table 23.58](#) or [Table 23.59](#) to the end of the catalog number. For example, CAD50B7.
 [2] Add the proper voltage code to the end of catalog number.
 [3] Auxiliary contact blocks with four contacts cannot be used on relays with low consumption coils.
 [4] Includes 1 N.O. and 1 N.C. overlapping contact.
 [5] Grounding terminal points (2 terminals jumpered together; see diagram on page 8 of Catalog 8501CT0101).

TeSys™ D IEC Style Contact Blocks and Accessories

Table 23.62: Time Delay Auxiliary Contact Blocks

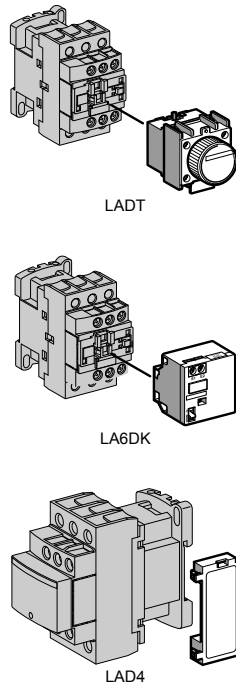

Number and Type of Contacts	Maximum Number per Device	Time Delay Type	Termination Type	Range	Catalog Number
	Front Mounting				
1 N.C. and 1 N.O.	1	On-Delay	Screw Clamp	0.1–3 s [6]	LADT0
				0.1–30 s	LADT2
				10–180 s	LADT4
			Spring Terminal	1–30 s [7]	LADS2
				0.1–3 s [6]	LADT03
				0.1–30 s	LADT23
		Off-Delay	Screw Clamp	10–180 s	LADT43
				1–30 s [7]	LADS23
				0.1–3 s [6]	LADR0
			Spring Terminal	0.1–30 s	LADR2
				10–180 s	LADR4
				0.1–3 s [6]	LADR03
			0.1–30 s	LADR23	
			10–180 s	LADR43	

NOTE: For Lockout Cover, see page 7 of catalog 8501CT0101.

Table 23.63: Mechanical Latch Blocks [8]

Unlatching Control	Maximum Number per Device	Catalog Number[9]
	Front Mounting	
Manual or electrical	1	LAD6K10

Table 23.64: Coil Suppressor Modules

These modules clip onto the right hand side of the control relay and the electrical connection is instantly made. Adding an input module is still possible.

RC Circuits (Resistor-Capacitor)

- Effective protection for circuits highly sensitive to "high frequency" interference.
- Voltage limited to 3 Uc maximum and oscillating frequency limited to 400 Hz maximum.
- Slight increase in drop-out time (1.2 to 2 times the normal time).

For Mounting On:	Operational Voltage	Catalog Number
CAD (Vac)	24 to 48 Vac	LAD4RCE
	110 to 240 Vac	LAD4RCU

Varistors (Peak Limiting)

- Protection provided by limiting the transient voltage value to 2 Uc maximum.
- Maximum reduction of transient voltage peaks.
- Slight increase in drop-out time (1.1 to 1.5 times the normal time).

CAD (Vac)	24 to 48 Vac	LAD4VE
	50 to 127 Vac	LAD4VG
	110 to 250 Vac	LAD4VU

Bidirectional Peak Limiting Diode

- Protection provided by limiting the transient voltage value to 2 Uc maximum.
- Maximum reduction of transient voltage peaks.

CAD (Vac)	24 Vac	LAD4TB
	72 Vac	LAD4TS

Table 23.65: Coil Voltage Codes

Volts (Vac/Vdc)	24	32/36	42/48	60/72	100	110/127	220/240
Code	B	C	E	EN	K	F	M

Table 23.66: Dimensions (See Figures at Left)

CAD (Vac Coil)	in. (mm)		CAD (Vdc Coil or Low Consumption Vdc Coil)	in. (mm)			
	32 50	323 503		32 50	323 503		
b	3.03 (77)	3.90 (99)	b	3.03 (77)	3.90 (99)		
c	Without cover or add-on blocks	3.31 (84)	3.31 (84)	Without cover or add-on blocks	3.66 (93)	3.66 (93)	
	With cover, without add-on blocks	3.39 (86)	3.39 (86)	With cover, without add-on blocks	3.74 (95)	3.74 (95)	
c1	with LADN or C (2 or 4 contacts)	4.61 (117)	4.61 (117)	c1	with LADN or C (2 or 4 contacts)	4.96 (126)	4.96 (126)
c2	with LA6DK10	5.08 (129)	5.08 (129)	c2	with LA6DK10	5.43 (138)	5.43 (138)
c3	with LADT, R, S	5.39 (137)	5.39 (137)	c3	with LADT, R, S	5.75 (146)	5.75 (146)
	with LADT, R, S and sealing cover	5.55 (141)	5.55 (141)		with LADT, R, S and sealing cover	5.91 (150)	5.91 (150)

Dimensions (in./mm)

CAD (Vac Coil)

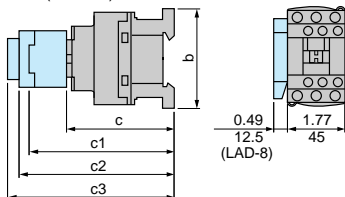

CAD (Vdc Coil or Low Consumption Vdc Coil)

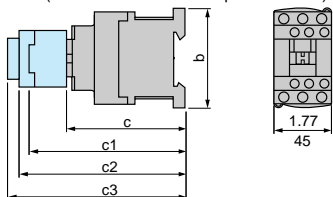

[6] With extended scale from 0.1 to 0.6 s.

[7] With switching time of 40 ms ± 15 ms between opening of the N.C. contact and closing of the N.O. contact.

[8] Power should not be simultaneously applied or maintained to the mechanical latching block and the CAD relay. The duration of the control signal to the mechanical latching block and the CAD relay should be greater than or equal to 100 ms.

[9] Complete the catalog number by adding the coil voltage code from Table 23.65. For example, LADK10B.

TeSys™ D IEC Style Accessories

Table 23.67: Cabling Accessory

Description		Catalog Number
Mounting Adapter For adapting existing wiring to a new product	Without coil suppression	LAD4BB
	With coil suppression	24 to 48 Vac
		50 to 127 Vac
	110 to 250 Vac	LAD4BBVU

Table 23.68: Electronic Serial Timer Modules [10]

On-Delay Type		
Mounted using adaptor LAD4BB, to be ordered separately, see listing above.		
Operational Voltage	Time Delay	Catalog Number
24 to 250 Vac	0.1 to 2 s	LA4DT0U
	1.5 to 30 s	LA4DT2U
	25 to 500 s	LA4DT4U

Table 23.69: Auto-Man-Stop Control Modules

For local override operation tests with two-position "Auto-Man" switch and "O-I" switch	
Mounted using adaptor LAD4BB, to be ordered separately, see listing above.	
Operational Voltage	Catalog Number
24 to 100 Vac	LA4DMK

Table 23.70: Accessories (ordered separately)

Description	For Mounting On:	Must be Ordered in Multiples of:	Catalog Number
For Marking			
Sheet of 64 self-adhesive blank labels 8 x 33	CAD, LAD (4 contacts), LAD6DK	10	LAD21
Sheet of 112 self-adhesive blank labels 8 x 12	LAD (2 contacts), LADT	10	LAD22
For Protection			
Lockout cover	LADT, LADR	1	LA9D901
Relay cover preventing access to the moving contact carrier	CAD	1	LAD9ET1

Table 23.71: Application Data

Type	CAD (Vac)	CAD (Vdc)	CAD (Vdc) Low Consumption
Rated Insulation Voltage (Ui)	Conforming to IEC 60947-1-1 Overvoltage category III and degree of pollution 3	690 V	690 V
	Conforming to UL, CSA	600 V	600 V
Rated Impulse Withstand Voltage (Uimp)	Conforming to IEC 60947-1-1	6 kV	6 kV
Separation of Electrical Circuits	To IEC 536 and VDE 0106	Reinforced insulation up to 400 V	
Conforming to Standards	IEC 60947-1-1, N-F C 63-140, VDE 0660, BS 4794, EN 60947-5-15		
Approvals	UL: File: E164353 CSA: File: LR43364 CE	CCN: NKCR Class: 3211 03	
Protective Treatment	Conforming to IEC 60068	"TH" (Tropical Finish). See page 23 of Catalog 8501CT0101 for details.	
Degree of Protection	Conforming to VDE 0106	Front face protected against direct finger contact IP 2X	Protection against direct finger contact

[10] For 24 V operation, the relay must be fitted with a 21 V coil (code Z7).

TeSys™ K IEC Style Control Relays

- Mounting on 35 mm DIN 3 track or 4 screw direct mounting.
- Screws in open “ready-to-tighten” position
- NEMA A600, Q600
- IEC AC15, DC13



CA2KN22



CA2KN403



CA4KN405



CA3KN407

Table 23.72: Control Relays





Control Circuit		Type of Termination	Contact Configuration		Catalog Number [11]	
						
Supply	Consumption		N.O.	N.C.		
AC	4.5 VA	Screw clamp	4	0	CA2KN40 ••	
			3	1	CA2KN31 ••	
			2	2	CA2KN22 ••	
			4	0	CA2KN403 ••	
			3	1	CA2KN313 ••	
			2	2	CA2KN223 ••	
		Spring Termination	Faston 1 x 6.35 or 2 x 2.8	4	0	CA2KN407 ••
				3	1	CA2KN317 ••
				2	2	CA2KN227 ••
				4	0	CA2KN405 ••
				3	1	CA2KN315 ••
				2	2	CA2KN225 ••
DC	3 W	Screw clamp	4	0	CA3KN40 ••	
			3	1	CA3KN31 ••	
			2	2	CA3KN22 ••	
			4	0	CA3KN403 ••	
			3	1	CA3KN313 ••	
			2	2	CA3KN223 ••	
		Spring Termination	Faston 1 x 6.35 or 2 x 2.8	4	0	CA3KN407 ••
				3	1	CA3KN317 ••
				2	2	CA3KN227 ••
				4	0	CA3KN405 ••
				3	1	CA3KN315 ••
				2	2	CA3KN225 ••

Table 23.73: Low Consumption Control Relays

Compatible with programmable controller outputs.

- LED indicator incorporated.
- Wide range coil (70 to 130% U_c), suppressor fitted as standard.
- Mounting on 35 mm DIN 3 track or 4 screw direct mounting.
- Screws in open “ready-to-tighten” position.

Control Circuit		Type of Termination	Contact Configuration		Catalog Number [12]	
						
Supply	Consumption		N.O.	N.C.		
DC	1.8 W	Screw clamp	4	0	CA4KN40 •••	
			3	1	CA4KN31 •••	
			2	2	CA4KN22 •••	
			4	0	CA4KN403 •••	
			3	1	CA4KN313 •••	
			2	2	CA4KN223 •••	
		Spring Termination	Faston 1 x 6.35 or 2 x 2.8	4	0	CA4KN407 •••
				3	1	CA4KN317 •••
				2	2	CA4KN227 •••
				4	0	CA4KN405 •••
				3	1	CA4KN315 •••
				2	2	CA4KN225 •••

[11] Complete the catalog number by adding the proper voltage code from Table 23.74, Table 23.75, Table 23.76, or Table 23.77. For example, CA2KN40G7.

[12] Complete the catalog number by adding the proper voltage code from Table 23.78. For example, CA4KN40BW3.

Table 23.74: Coil Voltage Codes for CA2K Control Relays (0.8–1.15 Uc) (0.85–1.10 Uc)—12 to 220/230 Vac 50/60 Hz

Voltage	12 Vac	24 Vac	36 Vac	42 Vac	48 Vac	110 Vac	120 Vac	127 Vac	208 Vac	220/230 Vac
Code	J7	B7	C7	D7	E7	F7	G7	FC7	L7	M7

NOTE: Up to and including 240 V, coil with integral suppression device available: add 2 to the code required. Example: **J72**.

Table 23.75: Coil Voltage Codes for CA2K Control Relays (0.8–1.15 Uc) (0.85–1.10 Uc)—230 to 660/690 Vac 50/60 Hz

Voltage	230 Vac	230/240 Vac	380/400 Vac	400 Vac	400/415 Vac	440 Vac	480 Vac	500 Vac	660/690 Vac
Code	P7	U7	Q7	V7	N7	R7	T7	S7	Y7

NOTE: Up to and including 240 V, coil with integral suppression device available: add 2 to the code required. Example: **J72**.

Table 23.76: Coil Voltage Codes for CA3K Control Relays (0.8–1.15 Uc)—12 to 72 Vdc

Voltage	12 Vdc	20 Vdc	24 Vdc	36 Vdc	48 Vdc	60 Vdc	72 Vdc
Code	JD	ZD	BD	CD	ED	ND	SD

NOTE: Coil with integral suppression device available: add 3 to the code required. Example: **JD3**.

Table 23.77: Coil Voltage Codes for CA3K Control Relays (0.8–1.15 Uc)—100 to 250 Vdc

Voltage	100 Vdc	110 Vdc	125 Vdc	200 Vdc	220 Vdc	230 Vdc	240 Vdc	250 Vdc
Code	KD	FD	GD	LD	MD	MPD	MUD	UD

NOTE: Coil with integral suppression device available: add 3 to the code required. Example: **JD3**.

Table 23.78: Coil Voltage Codes for CA4K, Low Consumption Control Relays (Wide Range Coil: 0.7–1.3 Uc)

Voltage	12 Vdc	24 Vdc	48 Vdc	72 Vdc
Code	JW3	BW3	EW3	SW3

Approvals for TeSys K IEC Style Control Relays

File: E164353
CCN: NKCR



File: LR43364
Class: 3211 03



TeSys™ K IEC Style Contact Blocks and Accessories

Table 23.79: Instantaneous Auxiliary Contact Blocks [13][14]

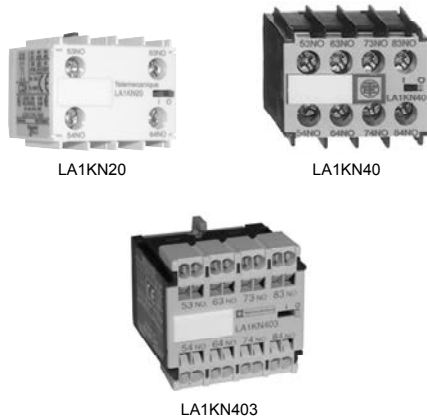

Approximate Dimensions for LA2KT Electronic Time Delay Contact Blocks (in./mm)

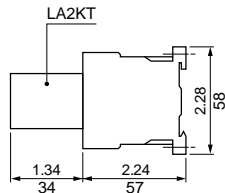
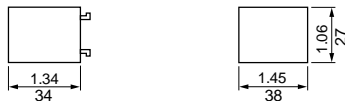

Approximate Dimensions for CA2, CA3, CA4K Control Relays (in./mm) On Panel

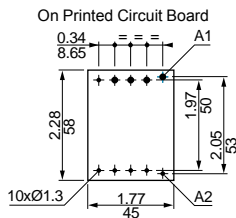
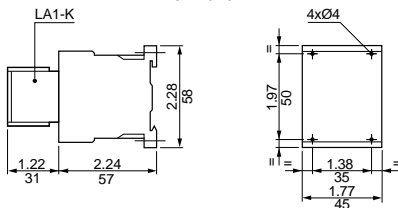

Type of Connection	Contact Configuration		Catalog Number	
	N.O.	N.C.		
	Clip-on Front Mounting, 1 Block Per Control Relay			
Screw Clamp	2	0	LA1KN20	
	0	2	LA1KN02	
	1	1	LA1KN11	
	4	0	LA1KN40[15]	
	3	1	LA1KN31[15]	
	2	2	LA1KN22[15]	
	1	3	LA1KN13[15]	
	0	4	LA1KN04[15]	
	Spring Termination	2	0	LA1KN203
		1	1	LA1KN13
0		2	LA1KN023	
4		0	LA1KN403[15]	
3		1	LA1KN313[15]	
2		2	LA1KN223[15]	
1		3	LA1KN133[15]	
0		4	LA1KN043[15]	
Faston 1 x 6.35 or 2 x 2.8		2	0	LA1KN207
		0	2	LA1KN027
	1	1	LA1KN117	
	4	0	LA1KN407[15]	
	3	1	LA1KN317[15]	
	2	2	LA1KN227[15]	
	1	3	LA1KN137[15]	
	0	4	LA1KN047[15]	

Table 23.80: Clip-On Front Mounting, 1 Block per Control Relay

Voltage	Type	Timing Range (s)	Composition C.O.	Catalog No.
AC or DC: 24 to 48	On-delay	1 to 30 s	1	LA2KT2E
AC: 110 to 240	On-delay	1 to 30 s	1	LA2KT2U

Table 23.81: Electronic Time Delay Contact Blocks

Relay output, with common point changeover contact	240 Vac/Vdc, 2 A maximum
Control voltage	0.85–1.1 Uc
Maximum switching capacity	250 VA or 150 W
Operating temperature	-10 to +60°C (+14° F to 140° F)
Reset time	1.5 s during the time delay period, 0.5 s after the time delay.

NOTE: For other electronic timers, see Type JCK60 and JCK70 Timers, page 23-43.

Table 23.82: Accessories (supplied separately)

Marker holder [16]	Description	Sold in lots of	Catalog No.
Clips on front of relay		100	LA9D90
Clip-on markers [16]	4 maximum per device	25	AB1R [16]
	Strip of 10 identical numbers, 0 to 9		AB1G [16]
Suppressor modules with locating device. No tools required for connection.	Strip of 10 identical capital letters A to Z	5	LA4KE1B [17]
	For 12 to 24 Vac and Vdc (varistor)		LA4KE1E [17]
	For 32 to 48 Vac and Vdc (varistor)		LA4KE1FC [17]
	For 50 to 129 Vac and Vdc (varistor)		LA4KE1UG [17]
	For 130 to 250 Vac and Vdc (varistor)		LA4KC1B [18]
	For 12 to 24 Vdc (diode + Zener diode)		LA4KE1E [18]
For 32 to 48 Vdc (diode + Zener diode)	LA4KA1U [19]		
For 220 to 250 Vac (RC)			

Table 23.83: Environment

Conforming to Standards		IEC 947, NF C 63-140, VDE 0660, BS 5424, CE
Approvals		UL, CSA, DEMKO, NEMKO, SEMKO, FI
Protective treatment	Conforming to IEC 68 (DIN 50016)	"TC" (Climateproof)
Degree of protection	Conforming to VDE 0106	Protection against direct finger contact
Ambient air temperature	Storage	-58 to 176 °F (-50 to 80°C)
	Operation	-13 to 122 °F (-25 to 50°C)
Max. operating altitude	Without derating	6562 ft (2000 m)

[13] Clip-on front mounting, 1 block per control relay.

[14] Auxiliary contact module not suitable for safety circuits.

[15] Not to be used on CA4K relays.

[16] See "Clip-in Marker Strips" in Catalog 8501CT0101 for information on completing the catalog number.

[17] Protection by the limitation of the transient voltage to 2 Uc maximum. Maximum reduction of the transient voltage peaks. Slight time delay on drop-out (1.1 to 1.5 times normal).

[18] No overvoltage or oscillation frequency. Polarized component. Slight time delay on drop-out (1.1 to 1.5 times normal).

[19] Protection by limitation of the transient voltage to 3 Uc max. and limitation of the oscillation frequency. Slight time delay on drop-out (1.2 times to twice normal).

TeSys™ SK IEC Style Control Relays

- Miniature size saves space.
- Up to 4 poles.
- Mounts on 35 mm DIN 3 track.



CA2SK11G7



LA1SK11



CA2SKE20

Table 23.84: IEC Style Industrial Control Relays

Control Circuit Supply	Consumption	Type of Termination	Contact Configuration		Catalog Number [20]
			N.O.	N.C.	
AC	4.2 VA	Screw clamp	1	1	CA2SK11 ••
			2	0	CA2SK20 ••
DC	2.2 W		1	1	CA3SK11 ••
			2	0	CA3SK20 ••

Table 23.85: Contact Adder Decks (for CA2SK20 only)

Type of Termination	Contact Configuration		Catalog Number
	N.O.	N.C.	
Screw clamp	2	0	LA1SK20
	1	1	LA1SK11
	0	2	LA1SK02

Transient Suppressor Module dampens the voltage spike that may occur when the relay coil is de-energized. The spike may adversely affect solid state equipment near the relay. The transient suppressor module snaps into a cavity located in the side of the relay. These modules can be used with CA2SK and CA3SK relays.

Table 23.86: Transient Suppressor Module

Control Circuit Voltage	Catalog Number
24–48 Vac 50/60 Hz, 24–48 Vdc	LA4SKEIE
110–250 Vac 50/60 Hz, 110–250 Vdc	LA4SKEIU

Table 23.87: Coil Voltage Codes for Control Relays

Voltage	12	24	36	48	72	110	120	220	230	240	277	380	400	480
50/60 Hz	—	B7 [21]	—	E7 [21]	—	F7	G7 [21]	M7 [21]	P7	U7 [21]	UE7	Q7	V7	T7 [21]
DC	JD	BD	CD	ED	SD	—	—	—	—	—	—	—	—	—

IEC Style Alternating Relays are used to alternate the use of 2 motor circuits. When the coil is energized the first time, one contact closes and will open when the coil is de-energized. When the coil is energized again, the other contact will close and will open when the coil is de-energized. The contacts from these alternators are to be used in the control circuit of the starters that are controlling pump or compressor motors.

Table 23.88: Alternating Relays

Coil Voltage (Voltage-Hz)	Type
24–50/60	CA2SKE20 •• [22]

Table 23.89: Contact Ratings for CA2SK, CA3SK, and CA2SKE20 Relays

V	AC						DC		
	NEMA Rating	Inductive 35% PF				Continuous Amperes		Resistive 75% PF	
		Make	Break	Make, Break and Continuous Amperes	Make, Break and Continuous Amperes				
120	A600	60	7200	6	720	10	10	24	3
240		30		3				60	2
480		15		1.5				110	0.8
600		12		1.2				240	0.2

Approximate Dimensions for CA2SKE Relay

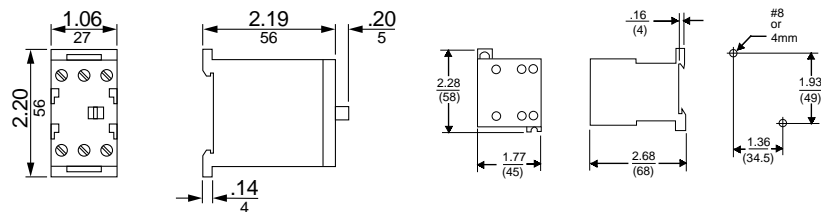

Dual Dimensions: INCHES / Millimeters

Approvals for TeSys SK IEC Style Relays



File: E164353
CCN: NKCR



File: LR43364
Class: 3211 03



[20] Use the appropriate voltage code from Table 23.87 to complete the catalog number. For example, CA2SK11G7.

[21] Alternating relays CA2SKE available in these voltages only. No other voltages are available.

[22] Use the appropriate voltage code from Table 23.87 to complete the catalog number (for example, CA2SK11G7). Only available with voltages indicated in this table.



8501XO40V02 AC Control Relay



8501XMO40V02 AC Master Relay

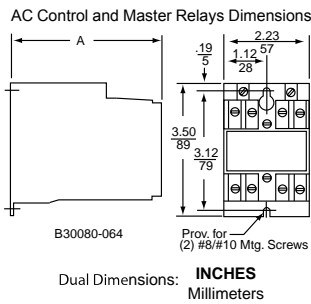

8501XO40XTE1V02 AC Timing Relay

Square D™ NEMA Style AC Relays

Class 8501 Type X relays combine a rugged, heavy-duty design with modular construction for greater flexibility. They are ideal for applications where long life, high reliability, and ease of maintenance are important. The Type X family offers a complete line of relays and accessories for most control applications. The 8501X relay consists of a standard 4 pole base to which it is possible to add additional contacts, timer, and latch functionality. Instantaneous and Master contacts are converted from N.O. to N.C. by flipping the contact cartridge within the base. The 8501X relay can either be built from individual part numbers or ordered pre-assembled.

AC Control Relays

- Straight-through wiring
- Plug-in contact cartridges for easy contact conversion and replacement
- Contact conversion without removing terminal screws or wires
- Self-lifting pressure wire connectors
- Replaceable coil

Table 23.90: AC Control Relays (lots of 1)

No. of N.O. 10 A Convertible Instantaneous Contacts ^[1]	Type ^{[1][2]}
0	XO00
2	XO20
3	XO30
4	XO40
6	XO60
8	XO80
10	XO1000
12	XO1200

AC Master Relays

- 20 ampere contact rating due to use of master contact cartridges.^[3]
- Provisions for standard cartridges to be used in contact cavities not occupied by master cartridges in 2-8 pole AC relay.

Table 23.91: AC Master Relays

No. of N.O. 20 A Convertible Contacts	Type ^{[2][4]}
2	XMO20
4	XMO40
6	XMO60

Table 23.92: Dimension A (See Figure at Left) and Weights

No. of Poles	Dim. A		Shipping Weight, lb
	in.	mm	
0-4	3.95	100	2.0
6-8	5.16	131	2.3
10-12	6.36	162	2.7

AC Timing Relays

- Easily convertible On or Off Delay
- Two adjustable timing ranges
- Repeat accuracy well above ±10%
- Convertible 1 N.O. and 1 N.C. timed contacts
- Large knob for easy adjustment of time delay
- Off Delay mode times out even after loss of power

Table 23.93: AC Timing Relays (lots of 1)

Timing Mode	No. of N.O. 10 A Convertible Instantaneous Contacts	Timed Convertible Contacts		Timing Relay	
		N.O.	N.C.	0.2-60 s	5-180 s
				Type ^[2]	Type ^[2]
On Delay	0	1	1	XO00XTE1	XO00XTE2
	2	1	1	XO20XTE1	XO20XTE2
	4	1	1	XO40XTE1	XO40XTE2
Off Delay	0	1	1	XO00XTD1	XO00XTD2
	2	1	1	XO20XTD1	XO20XTD2
	4	1	1	XO40XTD1	XO40XTD2

[1] A maximum of 8 N.C. contacts is allowed on 9-12 pole relays.

[2] Voltage code must be specified to order these products. Refer to Table 23.97 and insert the code as shown in Table 23.98.

[3] Maximum of six 8501 Type XC4 master cartridges may be used on only 7 and 8 pole AC devices.

[4] Attachments not permitted on this relay.



8501XO40XLV02 Latching Relay

AC Latching Relays

- Mechanical latch holds all contacts switched even after removal of power from replaceable latching coil.
- Provides sequence memory in the event of power loss. Ideal for press control, process control, and punch presses.
- Replaceable unlatch coil to switch contacts back to original state.

Table 23.94: AC Latching Relays (lots of 1)

N.O. 10 A Convertible Instantaneous Contacts	Latching Relay
	Type [5]
2	XO20XL
3	XO30XL
4	XO40XL
6	XO60XL
8	XO80XL

Table 23.95: Dimension A (See Figure at Left) and Weights

No. of Poles	Dim. A		Shipping Weight, lb
	in.	mm	
2-4	6.54	166	2.8
6-8	7.74	197	3.1

- For replacement coils, see Table 23.112.

Table 23.96: AC Contact Ratings

Type of Cartridge	V	NEMA Rating	Inductive 35% Power Factor				Continuous Amperes	Resistive 75% Power Factor Make, Break and Continuous Amperes
			Make		Break			
			A	VA	A	VA		
Standard or Overlapping	120	A600	60	7200	6	720	10	10
	240		30		3			
	480		15		1.5			
	600		12		1.2			
Master [6]	—	A600	Same as standard cartridge above except substitute 20 A for the continuous ampere rating					
Logic Reed	—	—	150 Vac, 150 mA, 8 W Maximum					

- For DC ratings, see Table 23.102.

Table 23.97: Voltage Codes

AC Voltages - Hz	Code
12-60	V11
24-60	V01
24-50	V12
48-60	V18
48-50	V16
120-60/110-50	V02
208-60	V08
240-60/220-50	V03
277-60	V04
480-60/440-50	V06
600-60/550-50	V07

Table 23.98: How to Order

To Order Specify:	Catalog Number		
• Class Number	Class	Type	Voltage Code
• Type Number	8501	XO40	V02
• Voltage Code			

Approvals for Square D NEMA Style Relays



File: E78403
CCN: NKCR



File: 060905
Class: 3211 03



IEC 60947-1

23 RELAYS AND TIMERS

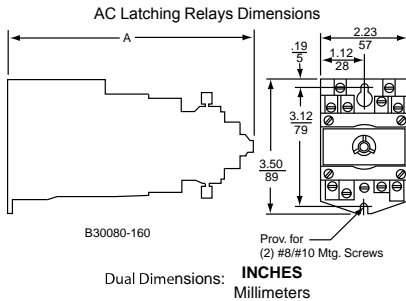

[5] Voltage code must be specified to order these products. Refer to Table 23.97 and insert the code as shown in Table 23.98.

[6] Maximum of six 8501 Type XC4 master cartridges may be used on only 7 and 8 pole AC devices.

Square D™ NEMA Style DC Relays

DC Control Relays

- Replaceable, highly reliable pure DC power plant: no economizing resistors, overlapping contacts or dual-wound coil.
- Uses the same Type XB adder decks and attachments as the AC version.
- Offers all the features of the AC relay.
- Available in up to 8 poles.
- All contact poles are usable since no overlapping contacts are needed.



8501XDO40V53 Control Relay

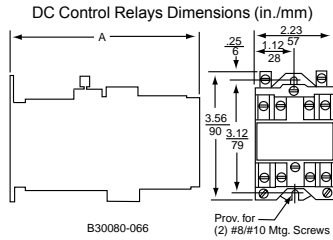

B30080-066



8501XDO40XTE2V53 Timing Relay

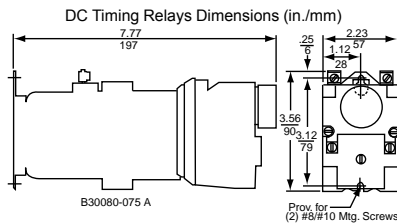

B30080-075 A

Table 23.99: DC Control Relays

Normally Open 5 A Convertible Instantaneous Contacts	Control Relay	
	Type ^[7]	
0	XDO00	
2	XDO20	
4	XDO40	
6	XDO60	
8	XDO80	

Table 23.100: Dimension A (See Figure at Left) and Weights

No. of Poles	Dim. A		Shipping Weight lb.
	in.	mm	
0-4	5.17	131	3.1
6-8	6.37	162	3.4
10-12	7.60	193	3.8

DC Timing Relays

- Easily convertible On Delay or Off Delay.
- Two adjustable timing ranges.
- Repeat accuracy well above ±10%.
- Convertible 1 N.O. and 1 N.C. timed contacts.
- Large knob for easy adjustment of time delay.
- Off Delay mode times out even after loss of power.

Table 23.101: DC Timing Relays

Timing Mode	Normally Open 5 A Convertible Instantaneous Contacts	Timed Convertible Contacts		Timing Relay ^[7]	
		N.O.	N.C.	0.2-60 s	
				Type	Type
On Delay	0	1	1	XDO00XTE1	XDO00XTE2
	2	1	1	XDO20XTE1	XDO20XTE2
	4	1	1	XDO40XTE1	XDO40XTE2
Off Delay	0	1	1	XDO00XTD1	XDO00XTD2
	2	1	1	XDO20XTD1	XDO20XTD2
	4	1	1	XDO40XTD1	XDO40XTD2

Table 23.102: DC Contact Ratings

Type of Cartridge	DC Ratings					
	Volts	Inductive			Resistive	
		NEMA Rating	Make and Break Amperes 138 VA Max.	Continuous Amperes	Make and Break Amperes	Continuous Amperes
Standard	125 250	P600	1.1 0.55	5 5	4 0.8	5 5
Overlapping	125	P150	1.1	5	4	5
Logic Reed	—	—	30 Vdc, 60 mA	—	—	—

- For AC ratings, see Table 23.96.

NOTE: Do not use any 8501 Type XC4 Master Cartridges on any DC-operated device.

[7] Voltage code must be specified to order these products. Refer to Table 23.106 and insert the appropriate code as shown in Table 23.107.



8501XDO40XDLV53 Latching Relay

DC Latching Relays Dimensions (in./mm)

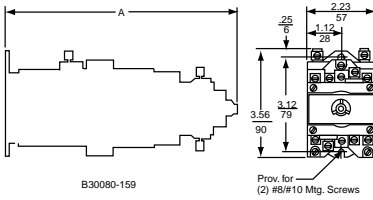

B30080-159

Prov. for
(2) #8/#10 Mtg. Screws



8501XUDO40V53 Utility Relay

DC Latching Relays

- Mechanical latch holds all contacts switched even after removal of power from replaceable latching coil.
- Provides sequence memory in the event of power loss.
- Ideal for sequencing applications such as press control, process control and punch presses.
- Replaceable unlatch coil to switch contacts back to original state.

Table 23.103: DC Latching Relays

Normally Open 5 A Convertible Instantaneous Contacts	Latching Relay [8]	
	Type	
2	XDO20XDL	
4	XDO40XDL	
6	XDO60XDL	
8	XDO80XDL	

NOTE: Unlatch coil is rated for intermittent duty and should be connected through a N.O. contact of the relay if the input signal is maintained. Order one more N.O. contact than the application requires to use as a coil clearing contact.

Table 23.104: Dimension A (See Figure at Left) and Weights

No. of Poles	Dim. A		Shipping Weight, lb.
	in.	mm	
2-4	7.76	197	3.9
6-8	8.98	228	4.2

DC Utility Relays

Ideal for utility plant applications where reliable performance and a pure DC power plant is required. In addition to the Type XDO relay features, the Type XUDO provides:

- Up to 12 poles N.O. or N.C.
- Nominal 125 Vdc coil, capable of handling 140 Vdc continuously and picking up at 105 Vdc after having been operated at 140 Vdc continuously. Other voltages with comparable operating characteristics are available.
- Enclosed device capable of operating in 145°F ambient.

Table 23.105: DC Utility Relays

Number of 5 A Convertible Contacts		Open Type[8]
N.O.	N.C.	Type
4	0	XUDO40
0	4	XUDO04
8	0	XUDO80
0	8	XUDO08
12	0	XUDO1200
0	12	XUDO0012

Table 23.106: Voltage Codes—8501 XUDO and XDO Relays

DC Voltages for 8501 XUDO Relays ONLY	Code	DC Voltages for 8501 XDO Relays	Code
6	V50	6	V50
12	V51	12	V51
24	V53	24	V53
48	V56	32	V54
125	V63	48	V56
250	V67	72	V58
—	—	90	V59
—	—	115/125	V62
—	—	230/250	V66

Table 23.107: How to Order

To Order Specify:	Catalog Number		
	Class	Type	Voltage Code
<ul style="list-style-type: none"> • Class Number • Type Number • Voltage Code 	8501	XDO40	V53

- For replacement coils, see [Table 23.111](#).
- For UL and CSA approvals, see [Square D NEMA Style AC Relays](#).

[8] Voltage code must be specified to order these products. Refer to [Table 23.106](#) and insert the appropriate code as shown in [Table 23.107](#).

Attachments and Accessories for Square D™ NEMA Style Relays

Table 23.108: Type X™ Relays



	Description	Type
	Mechanical Latch Attachment —Mounts on any 2 through 8-pole relay (except XMO master relay). The Type XL and XDL latch attachments are identical in size and mounting provisions. The Type XLAC latch attachment has a continuous-duty-rated coil which is replaceable. The Type XDLDC latch attachment has an intermittent-rated coil (replaceable) and should be connected through a N.O. contact of the basic relay if the input signal is maintained to the unlatch coil. AC Latch Attachment DC Latch Attachment	XL [9] XDL[9]
	Pneumatic Timer Attachment —Mounts only on any 0 through 4-pole AC or DC relays (except XMO master relay). It provides 1 N.O. and 1 N.C. convertible timed contacts, which are the same Type XC1 cartridges used on the basic relay. Two timing ranges are available, and conversion from On Delay to Off Delay or vice versa is easy. Off Delay 0.2–60 seconds 5–180 seconds On Delay 0.2–60 seconds 5–180 seconds	XTD1 XTD2 XTE1 XTE2
	Timer Lockout Cover —Fits over the time delay adjustment knob of any Type XT timing attachment. The Lockout Cover is designed to protect the time setting against accidental adjustment. It mounts directly to the timing attachment with two included screws.	XJ1
	Adder Decks —Adder decks are used to expand the number of poles on a relay. The basic 4-pole relay can be easily converted to an 8-pole or 12-pole relay by installing one or two adder decks. The Class 8501 Type XB20 comes with 2 convertible contact cartridges and will accept 2 additional convertible contact cartridges. The Class 8501 Type XB40 comes with 4 convertible contact cartridges. The same Type XB adder deck is used for both the middle and upper decks of the AC or DC relay.	
	With 2 N.O. contact cartridges	XB20
	With 4 N.O. contact cartridges	XB40
	Contact Cartridges —The Type X relay offers 4 Types of contact cartridges. All are color-coded for visual identification of each Type.	
	Standard Cartridge —The standard cartridge, used for most applications, has a black case.	XC1
	Overlapping Cartridge —Same NEMA Type A600 AC rating as standard cartridge and a NEMA Type P150 DC rating. When it is used in the N.O. mode it will close early and when used in the N.C. mode it will open late. If two or more are used together, the N.O. contacts will close before the N.C. contacts open as the relay picks up. Overlap also occurs during dropout. Overlapping cartridge has a red case. May be ordered factory installed: <ul style="list-style-type: none"> Substitute 1 N.O. and 1 N.C. overlapping cartridges for 2 standard cartridges. Substitute 2 N.O. and 2 N.C. overlapping cartridges for 4 standard cartridges. Substitute 3 N.O. and 3 N.C. overlapping cartridges for 6 standard cartridges. Substitute 4 N.O. and 4 N.C. overlapping cartridges for 8 standard cartridges. 	XC2
	Master Cartridge —Features the same contact ratings as the Type XC1 standard cartridge except it has a 20 ampere continuous current rating instead of 10 amperes. It can be used in circuits where a master relay is required. Master cartridge has a blue case. Maximum of 6 master cartridges may be used on any 7 and 8-pole AC relays. Do not use any master cartridges on 9-12-pole AC or any DC-operated devices. Note: If master cartridges are added to a standard relay, attachments (latch mechanism, timers, etc.) cannot be used.	XC4
	Mounting Track —The mounting track has pre-punched mounting holes to simplify mounting the track on the control panel. The relay mounting screws are factory installed on the track so that the relays can be hung prior to tightening the screws. 9 in. long for 4 relays 18 in. long for 8 relays 27 in. long for 12 relays 36 in. long for 16 relays	XM4 XM8 XM12 XM16
	Manual Test Tool —Provides a means of manually switching the contacts of a basic relay or timing relay and holding all contacts in their switched state until the tool is removed. This simplifies the checking of control circuits without power on the coil or contacts.	XA1
	Transient Suppressor —Consists of an R-C circuit designed to suppress coil generated transients to approximately 200 percent of peak voltage. It is particularly useful when switching the Type X relay near solid state equipment. It is designed for use on coils up to 120 Vac.	XS1
	NEMA 1 Enclosure —Formed from sheet steel to provide strength and rigidity. Two conduit knockouts are located in both the top and bottom of the enclosure. The enclosure is furnished with self tapping screws for mounting the relay inside the enclosure. Accommodates a single 4 or 8-pole AC or DC relay, 12-pole AC relay, 4-pole AC latching relay, and 4-pole AC timing relay. NOTE: The 4-pole DC latching relay, 4-pole DC timing relay, 8-pole AC and DC latching relays and 12-pole utility auxiliary relay will not fit.	Class 9991 Type UE7

Table 23.109: Mechanical Latch Attachment Voltage Codes

AC Voltage	Code	DC Voltage	Code
24–60	V01	6	V50
24–50	V12	12	V51
120–60/110–50	V02	18	V99
208–60	V08	24	V53
240–60/220–50	V03	48	V56
277–60	V04	72	V58
480–60/440–50	V06	90	V59
600–60/550–50	V07	115/125	V62
		230/250	V66

Table 23.110: How to Order

To Order Specify:	Catalog Number	
<ul style="list-style-type: none"> Class Number Type Number Voltage Code for mechanical latch attachment Form for factory installed overlapping contacts 	Class	Type
	8501	XTE1

[9] See Table 23.109.

Table 23.111: DC Relay Coil Selection

Equipment To Be Serviced		Coil Prefix, or Class and Type	Hz	Suffix (The complete coil number consists of prefix or the Class and Type, followed by suffix.)													Coil Burden Watts
Class	Type			6 V	12 V	18 V	24 V	32 V	48 V	64 V	72 V	90 V	110 V	115/125 V	220 V	230/250 V	
8501	XD	9998 XD	—	19	28	34	37	40	46	49	52	55	—	58	—	67	18
	XDL	9998 XDL	—	19	28	34B	37B	40B	46B	49B	52B	55B	—	58B	—	67B	50
	XUD	9998 XUD	—	19	28	—	37	—	46	—	—	—	—	58 [10]	—	67 [11]	16

Table 23.112: AC Relay Coil Selection

Equipment To Be Serviced		Coil Prefix or Class and Type	Suffix (The complete coil number consists of prefix or the Class and Type, followed by suffix.)												Coil Volt-Amperes		
Class	Type		—	24 V	110-115 V	120 V	208 V	220 V	240 V	277 V	380 V	440 V	480 V	550 V	600 V	In-rush	Sealed
8501	XO, XMO	9998 X [12]	60	23	—	44	51	52	53	55	—	—	62	—	65	148	23
			50	24	44	—	52	53	—	—	—	—	62	—	65	—	143

[10] 125 Vdc only

[11] Not dual rated—250 Vdc only

[12] To order an unlatch coil, add the letter L to the type number and the letter B to the suffix number. Example: for a 120 V 60 Hz unlatch coil, order a Class 9998 Type XL44B.

New!

Zelio™ SSL Relays

Zelio SSL solid state relays offer the advantages of several input and output configurations for both AC and DC switching applications. Their compact size and modular design reduces space and allows easy mounting on the socket. Key features include:

- Available with zero voltage switching for resistive load and random switching for inductive load applications.
- Socket with reverse polarity protection circuit and LED indicator for easy identification of control status.

Refer to [Online Relay Configurator](#).

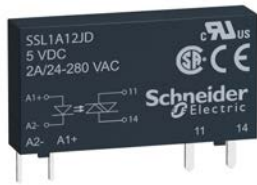

SSL1A12JD



SSLVA1



RSL Z2



RSL Z3

Table 23.113: Relays (sold in lots of 12)

Switching	Input Voltage	Output Voltage	Contact Configuration	Load Current Range	SPDT (1 C/O)
					Catalog Number
DC switching	3–12 Vdc	1–24 Vdc	SPST N.O. (1 N/O)	3.5 A	SSL1D03JD
		1–48 Vdc	SPST N.O. (1 N/O)	0.1 A	SSL1D101JD
	15–30 Vdc	1–24 Vdc	SPST N.O. (1 N/O)	3.5 A	SSL1D03BD
		1–48 Vdc	SPST N.O. (1 N/O)	0.1 A	SSL1D101BD
	38–72 Vdc	1–24 Vdc	SPST N.O. (1 N/O)	3.5 A	SSL1D03ND
		1–48 Vdc	SPST N.O. (1 N/O)	0.1 A	SSL1D101ND
Zero voltage switching	3–12 Vdc	24–280 Vac	SPST N.O. (1 N/O)	2 A	SSL1A12JD
	15–30 Vdc	24–280 Vac	SPST N.O. (1 N/O)	2 A	SSL1A12BD
	38–72 Vdc	24–280 Vac	SPST N.O. (1 N/O)	2 A	SSL1A12ND
Random switching	3–12 Vdc	24–280 Vac	SPST N.O. (1 N/O)	2 A	SSL1A12JDR
	15–30 Vdc	24–280 Vac	SPST N.O. (1 N/O)	2 A	SSL1A12BDR
	38–72 Vdc	24–280 Vac	SPST N.O. (1 N/O)	2 A	SSL1A12NDR

Table 23.114: Sockets (sold in lots of 10)

Control Voltage	For Use with Relays	Socket Type	
		Screw Connector	Spring Terminal
		Catalog Number	Catalog Number
5 Vdc	SSL1D03JD SSL1D101JD SSL1A12JD SSL1A12JDR	SSLZVA1	SSLZRA1
24 Vdc	SSL1D03BD SSL1D101BD SSL1A12BD SSL1A12BDR	SSLZVA1	SSLZRA1
60 Vdc	SSL1D03ND SSL1D101ND SSL1A12ND SSL1A12NDR	SSLZVA2	SSLZRA2
110 Vac/Vdc	SSL1D03ND SSL1D101ND SSL1A12ND SSL1A12NDR	SSLZVA3	SSLZRA3
230 Vac/Vdc	SSL1D03ND SSL1D101ND SSL1A12ND SSL1A12NDR	SSLZVA4	SSLZRA4

Table 23.115: Accessories

Description	Compatibility	Catalog Number
ID tags (2 sheets of 64 tags)		RSLZ5
Bus jumper (10 x 20-pole jumper)	RSL series sockets, SSL series sockets	RSLZ2
Butterfly isolator (10 isolators)		RSLZ3

Approvals for SSL Relays



File:
E173076
CCN:
NRNT2,
NRNT8



File:
257594
Class:
3211 07



IEC 60950–1 RoHS Compliant

Approvals for SSLZ Sockets



File:
E172326
CCN:
SWIV2



File:
254977
Class:
3211 07



IEC 60950–1 RoHS Compliant

New!

Zelio™ SSM Relays

Zelio SSM solid state relays are ready-to-use modular relays with SCR/MOSFET outputs for greater switching density. The unique IP20 housing design and integrated heat sink with no exposed metal surface offers compactness and enhances operating conditions of the relay. SSM relays are DIN rail mounted and available with zero voltage switching for resistive load and random switching for inductive load applications. The SSM relay range comprises:

- SSM1: Single channel, single-phase relays with 6 A and 12 A ratings
- SSM2: Dual channel, single-phase relays with 6 A rating

Refer to [Online Relay Configurator](#).



SSM1A36BD



SSM1A312BD

Table 23.116: SSM1 Single Channel Solid State Relays (sold in lots of 1)

Switching	Input Voltage	Output Voltage	Contact Configuration	Load Current Range	Motor Load Rating	Catalog Number	
DC switching	4–32 Vdc	1–60 Vdc	SPST N.O. (1 N/O)	6 A	–	SSM1D26BD	
			SPST N.O. (1 N/O)	12 A	–	SSM1D212BD	
		1–100 Vdc	SPST N.O. (1 N/O)	6 A	–	SSM1D36BD	
			SPST N.O. (1 N/O)	12 A	–	SSM1D312BD	
Zero voltage switching	4–32 Vdc	24–280 Vac	SPST N.O. (1 N/O)	6 A	1/6 hp @ 240 Vac	SSM1A16BD	
			SPST N.O. (1 N/O)	12 A	1/3 hp @ 240 Vac	SSM1A112BD	
		48–600 Vac	SPST N.O. (1 N/O)	6 A	1/6 hp @ 240 Vac	SSM1A36BD	
			SPST N.O. (1 N/O)	12 A	1/3 hp @ 240 Vac	SSM1A312BD	
	18–36 Vac	24–280 Vdc	SPST N.O. (1 N/O)	6 A	1/6 hp @ 240 Vac	SSM1A16B7	
			SPST N.O. (1 N/O)	12 A	1/3 hp @ 240 Vac	SSM1A112B7	
		48–600 Vac	SPST N.O. (1 N/O)	12 A	1/3 hp @ 240 Vac	SSM1A312B7	
			SPST N.O. (1 N/O)	6 A	1/6 hp @ 240 Vac	SSM1A16F7	
	90–140 Vac	24–280 Vac	SPST N.O. (1 N/O)	12 A	1/3 hp @ 240 Vac	SSM1A112F7	
			SPST N.O. (1 N/O)	12 A	1/3 hp @ 240 Vac	SSM1A312F7	
		48–600 Vac	SPST N.O. (1 N/O)	6 A	1/6 hp @ 240 Vac	SSM1A16P7	
			SPST N.O. (1 N/O)	12 A	1/3 hp @ 240 Vac	SSM1A112P7	
	200–265 Vac	24–280 Vac	SPST N.O. (1 N/O)	12 A	1/3 hp @ 240 Vac	SSM1A312P7	
			SPST N.O. (1 N/O)	6 A	1/6 hp @ 240 Vac	SSM1A16BDR	
		4–32 Vdc	24–280 Vac	SPST N.O. (1 N/O)	12 A	1/3 hp @ 240 Vac	SSM1A112BDR
				SPST N.O. (1 N/O)	6 A	1/6 hp @ 240 Vac	SSM1A36BDR
48–600 Vac	SPST N.O. (1 N/O)		12 A	1/3 hp @ 240 Vac	SSM1A312BDR		
	SPST N.O. (1 N/O)		6 A	1/6 hp @ 240 Vac	SSM1A16B7R		
Random switching	18–36 Vac	24–280 Vac	SPST N.O. (1 N/O)	12 A	1/3 hp @ 240 Vac	SSM1A112B7R	
			SPST N.O. (1 N/O)	12 A	1/3 hp @ 240 Vac	SSM1A312B7R	
		48–600 Vac	SPST N.O. (1 N/O)	6 A	1/6 hp @ 240 Vac	SSM1A16F7R	
			SPST N.O. (1 N/O)	12 A	1/3 hp @ 240 Vac	SSM1A112F7R	
	90–140 Vac	24–280 Vac	SPST N.O. (1 N/O)	12 A	1/3 hp @ 240 Vac	SSM1A312F7R	
			SPST N.O. (1 N/O)	6 A	1/6 hp @ 240 Vac	SSM1A16P7R	
		48–600 Vac	SPST N.O. (1 N/O)	12 A	1/3 hp @ 240 Vac	SSM1A112P7R	
			SPST N.O. (1 N/O)	12 A	1/3 hp @ 240 Vac	SSM1A312P7R	



SSM2A36BD

Table 23.117: SSM2 Dual Channel Solid State Relays (sold in lots of 1)

Switching	Input Voltage	Output Voltage	Contact Configuration	Load Current Range	Catalog Number [1]
Zero voltage switching	4–32 Vdc	24–280 Vac	DPST N.O. (2 N/O)	6	SSM2A16BD
		48–600 Vac	DPST N.O. (2 N/O)	6	SSM2A36BD
Random switching	4–32 Vdc	24–280 Vac	DPST N.O. (2 N/O)	6	SSM2A16BDR
		48–600 Vac	DPST N.O. (2 N/O)	6	SSM2A36BDR

Approvals for SSM Relays



File: E359576
CCN: NMFT2,
NMFT8



File: 257594
Class: 3211 04



IEC
60950-1

RoHS
Compliant

[1] 4-pin connector for dual channel output only. Mating connector: MOLEX 050579404 or equivalent.



SSRPCDS25A1



SSRDCDS10A1



SSRDCDS45A1



SSRAH1

Zelio™ SSRP and SSRD Relays

Zelio SSRP and SSRD relays do not have any moving parts to wear out. Combined with vibration resistance, arc-less switching and the lack of acoustical noise, solid state relays are the ideal product for switching applications that demand reliable execution. For added reliability, the Zelio SSRP and SSRD solid state relays use Direct Copper Bonding (DCB) technology to decrease internal temperatures and improve the overall quality of the product. The SSR solid state relay range comprises:

- Relays for DIN rail mounting: SSRD
- Relays for panel mounting: SSRP

Key features include:

- Input voltage range 3–32 Vdc, 90–280 Vac
- Breaking capacities up to 125 A
- Zero voltage turn on, low EMI/RFI
- No moving parts
- Shock and vibration resistant
- No acoustical noise
- Fast response
- Arc-less switching
- Long life (>10⁹ operations typical)

Refer to [Online Relay Configurator](#).

Table 23.118: SSRP Single Channel Solid State Relays (sold in lots of 1)

Switching	Input Voltage	Output Voltage	Contact Configuration	Load Current Range	Catalog Number [2]
DC switching	3.5–32 Vdc	0–100 Vdc	SPST N.O. (1 N/O)	12	SSRPCDM12D5
			SPST N.O. (1 N/O)	25	SSRPCDM25D5
			SPST N.O. (1 N/O)	40	SSRPCDM40D5
Zero voltage switching	3–32 Vdc	24–280 Vac	SPST N.O. (1 N/O)	10	SSRPCDS10A1
			SPST N.O. (1 N/O)	25	SSRPCDS25A1
			SPST N.O. (1 N/O)	50	SSRPCDS50A1
	4–32 Vdc	48–530 Vac	SPST N.O. (1 N/O)	75	SSRPCDS75A2
			SPST N.O. (1 N/O)	90	SSRPCDS90A3
			SPST N.O. (1 N/O)	125	SSRPCDS125A3
	90–280 Vdc	24–280 Vac	SPST N.O. (1 N/O)	10	SSRPP8S10A1
			SPST N.O. (1 N/O)	25	SSRPP8S25A1
		48–530 Vac	SPST N.O. (1 N/O)	50	SSRPP8S50A1
			SPST N.O. (1 N/O)	75	SSRPP8S75A2
		48–660 Vac	SPST N.O. (1 N/O)	90	SSRPP8S90A3
			SPST N.O. (1 N/O)	125	SSRPP8S125A3

Table 23.119: SSRD Single Channel Solid State Relays (sold in lots of 1)

Switching	Input Voltage	Output Voltage	Contact Configuration	Load Current Range	Catalog Number
Zero voltage switching	90–280 Vac	24–280 Vac	SPST N.O. (1 N/O)	10	SSRDP8S10A1
			SPST N.O. (1 N/O)	20	SSRDP8S20A1
			SPST N.O. (1 N/O)	30	SSRDP8S30A1
	90–140 Vac	24–280 Vac	SPST N.O. (1 N/O)	45	SSRDF8S45A1
	4–32 Vdc	24–280 Vac	SPST N.O. (1 N/O)	10	SSRDCDS10A1
			SPST N.O. (1 N/O)	20	SSRDCDS20A1
			SPST N.O. (1 N/O)	30	SSRDCDS30A1
	3–32 Vdc	24–280 Vac	SPST N.O. (1 N/O)	45	SSRDCDS45A1

Approvals for SSRP and SSRD Relays



File: E258297
CCN: NRNT2,
NRNT8



File: 230765
Class: 3211 07



RoHS
Compliant

[2] See Table 23.121 for accessories.

New!

Zelio™ SSP Relays

Zelio SSP solid state relays are three-phase panel mounted relays with IP20 housing. The SCR outputs allow them to be used in various power switching applications. These power relays with 25 A and 50 A current rating are EMC compliant. SSP relays are integrated with an R-C snubber circuit and TVS (Transient Voltage Suppression). They are available with zero voltage switching for resistive load and random switching for inductive load applications.

Refer to [Online Relay Configurator](#).



SSP3A225P7

Table 23.120: SSP Three-Phase Solid State Relays (sold in lots of 1)

Switching	Input Voltage	Output Voltage	Contact Configuration	Load Current Range	Motor Load Rating	Catalog Number [3]	
Zero voltage switching	4–32 Vdc	48–530 Vac	3PST N.O. (3 N/O)	25 A	3/4 hp @ 120 Vac 1 hp @ 240 Vac 3 hp @ 480 Vac 4.4 hp @ 530 Vac	SSP3A225BD	
				50 A	1.5 hp @ 120 Vac 3 hp @ 240 Vac 7.5 hp @ 480 Vac 8.8 hp @ 530 Vac	SSP3A250BD	
	18–36 Vac	48–530 Vac	3PST N.O. (3 N/O)	25 A	3/4 hp @ 120 Vac 1 hp @ 240 Vac 3 hp @ 480 Vac 4.4 hp @ 530 Vac	SSP3A225B7	
				50 A	1.5 hp @ 120 Vac 3 hp @ 240 Vac 7.5 hp @ 480 Vac 8.8 hp @ 530 Vac	SSP3A250B7	
	90–140 Vac	48–530 Vac	3PST N.O. (3 N/O)	25 A	3/4 hp @ 120 Vac 1 hp @ 240 Vac 3 hp @ 480 Vac 4.4 hp @ 530 Vac	SSP3A225F7	
				50 A	1.5 hp @ 120 Vac 3 hp @ 240 Vac 7.5 hp @ 480 Vac 8.8 hp @ 530 Vac	SSP3A250F7	
	180–280 Vac	48–530 Vac	3PST N.O. (3 N/O)	25 A	3/4 hp @ 120 Vac 1 hp @ 240 Vac 3 hp @ 480 Vac 4.4 hp @ 530 Vac	SSP3A225P7	
				50 A	1.5 hp @ 120 Vac 3 hp @ 240 Vac 7.5 hp @ 480 Vac 8.8 hp @ 530 Vac	SSP3A250P7	
	Random switching	4–32 Vdc	48–530 Vac	3PST N.O. (3 N/O)	25 A	3/4 hp @ 120 Vac 1 hp @ 240 Vac 3 hp @ 480 Vac 4.4 hp @ 530 Vac	SSP3A225BDR
					50 A	1.5 hp @ 120 Vac 3 hp @ 240 Vac 7.5 hp @ 480 Vac 8.8 hp @ 530 Vac	SSP3A250BDR
		18–36 Vac	48–530 Vac	3PST N.O. (3 N/O)	25 A	3/4 hp @ 120 Vac 1 hp @ 240 Vac 3 hp @ 480 Vac 4.4 hp @ 530 Vac	SSP3A225B7R
					50 A	1.5 hp @ 120 Vac 3 hp @ 240 Vac 7.5 hp @ 480 Vac 8.8 hp @ 530 Vac	SSP3A250B7R
90–140 Vac		48–530 Vac	3PST N.O. (3 N/O)	25 A	3/4 hp @ 120 Vac 1 hp @ 240 Vac 3 hp @ 480 Vac 4.4 hp @ 530 Vac	SSP3A225F7R	
				50 A	1.5 hp @ 120 Vac 3 hp @ 240 Vac 7.5 hp @ 480 Vac 8.8 hp @ 530 Vac	SSP3A250F7R	
180–280 Vac		48–530 Vac	3PST N.O. (3 N/O)	25 A	3/4 hp @ 120 Vac 1 hp @ 240 Vac 3 hp @ 480 Vac 4.4 hp @ 530 Vac	SSP3A225P7R	
				50 A	1.5 hp @ 120 Vac 3 hp @ 240 Vac 7.5 hp @ 480 Vac 8.8 hp @ 530 Vac	SSP3A250P7R	

[3] Add a T to the end of the part number to order the SSP with a thermal pad interface.

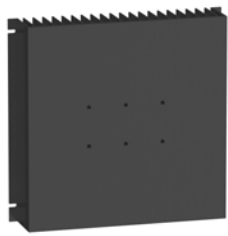

SSRHP02

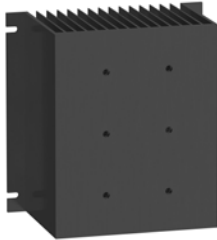

SSRHP05

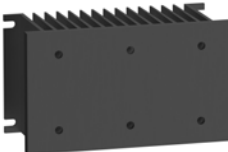

SSRHP10



SSRAT1

Table 23.121: Accessories

Description	Compatibility	Thermal Resistance	Catalog Number
Heat sink panel mount (lot of 10)	1 x SSP 1 x SSRP 2 x SSRP 3 x SSRP	0.2 °C/W	SSRHP02
	1 x SSP 1 x SSRP 2 x SSRP 3 x SSRP	0.5 °C/W	SSRHP05
	1 x SSP 1 x SSRP 2 x SSRP	1 °C/W	SSRHP10
	1 x SSRP 2 x SSRP	1.7 °C/W	SSRHP17
	1 x SSRP	2.5 °C/W	SSRHP25
	1 x SSRP 2 x SSRP	0.9 °C/W	SSRAH1
Heat sink DIN rail mount (lot of 1)	1 x SSP 1 x SSRP 2 x SSRP	1 °C/W	SSRHD10
Thermal pad interface (lot of 10)	SSRPP8S**** SSRPCDS**** SSRPCDM****	—	SSRAT1

Approvals for SSP Relays



File: E359576
CCN: NMFT2,
NMFT8



File: 257594
Class: 3211 04



IEC
60950-1

RoHS
Compliant

Zelio™ RE17 Modular Timers

The Zelio RE17 modular timer range is comprised of both 8 A relay and 0.7 A solid state outputs. Thanks to its space saving 17.5 mm design, this relay is ideal for applications that require a lot of control in a small foot print. The RE17 series is designed to attach to a 35 mm DIN rail.

- Multifunction, dual function, or single function
- Multi-range (7 selectable ranges)
- Multivoltage
- Solid state or relay output options

Table 23.122: RE17 Series Timers

Supply Voltage	Timing Ranges	Output Type	Rated Current	Functions	Function Descriptions [1]	Catalog Number
24–240 Vac/ Vdc	0.1 s to 100 h	SPST Solid State	0.7 A	A	Power On delay	RE17LAMW
24–240 Vac	0.1 s to 100 h	SPST Solid State	0.7 A	H	Interval	RE17LHBM
				C	Off delay with control signal	RE17LCBM
				L, Li	Asymmetrical flasher	RE17LLBM
				A, At, B, C, H, Ht, D, Di, Ac, Bw	Multi-function	RE17LMBM
24 Vdc, 24–240 Vac	0.1 s to 100 h	SPDT Relay	8 A	B	Interval with control signal	RE17RBMU
				C	Off delay with control signal	RE17RCMU
				A, At	Power on delay	RE17RAMU
				H, Ht	Interval	RE17RHMU
				L, Li	Asymmetrical flasher	RE17RLMU
				A, At, B, C, H, Ht, D, Di, Ac, Bw	Multi-function	RE17RMMU
				Ad, Ah, N, O, P, Pt, T, Tt, W	Multi-function	RE17RMXMU
				A, At, B, C, H, Ht, D, Di	Multi-function	RE17RMEMU
				L, Li	Asymmetrical flasher	RE17RLJU
				A, At, B, C, H, Ht, D, Di, Ac, Bw	Multi-function	RE17RMJU
12 Vdc	0.1 s to 100 h	SPDT Relay	8 A	L, Li	Asymmetrical flasher	RE17RLJU
12–240 Vac	0.1 s to 100 h	SPDT Relay	8 A	A, At, B, C, H, Ht, D, Di, Ac, Bw	Multi-function	RE17RMMW
12–240 Vac	0.1 s to 100 h	SPDT Relay	8 A	A, At, B, C, H, Ht, D, Di, Ac, Bw	Multi-function	RE17RMMWS



RE17LAMW



RE17LMBM



RE17RLMU

Approvals for RE17 Timers



File: E173076
CCN: NRNT, NRNT7



File: 248382
Class: 3211-06



IEC
61812-1

RoHS
Compliant

[1] For detailed function definitions, see Table 23.128.



RE48ATM12MW



RE48AMH13MW



RUZC3M



RE48ASOC11AR



RE48ASOC8SOLD



RE48ASOC11SOLD



RE48ASETMOV



RE48AIPCOV

Zelio™ RE48 Panel Mount Timers

The Zelio RE48 panel mount timer range is comprised of 5 A relay outputs. The unit can be mounted either on a panel or on a DIN rail with the optional octal socket. Thanks to the large selector knob, the user can quickly and easily see the current value selected and change it if needed.

- Time unit selector knob
- Multifunction, single function, or dual function
- 1.2 second to 300 hour timing range
- Wide input voltage range
- 5 A relay outputs
- Panel-mounted or plug-in
- LED indication

Table 23.123: RE48 Series Timers

Supply Voltage	Timing Ranges	Pin Configuration	Output Type	Rated Current	Functions	Function Descriptions [2]	Catalog Number
24–240 Vac/Vdc	1.2 s to 300 h	8–Pin Octal	DPDT Relay	5 A	A	Power On delay	RE48ATM12MW
					A1, A2, H1, H2	Delay On Energization, Pulse-on Energization	RE48AMH13MW
24–240 Vac/Vdc	1.2 s to 300 h	11–Pin Octal	DPDT Relay	5 A	L, Li	Asymmetrical flasher	RE48ACV12MW
					A, B, C, Di	Multi-function	RE48AML12MW

Table 23.124: Sockets (sold in lots of 10)

Description	Connection	Compatibility	Catalog Number
Mixed 8–Pin DIN Rail Mountable Socket	Box lug connector, DIN rail mount	RE48ATM12MW, RE48AMH13MW	RUZC2M
Mixed 11–Pin DIN Rail Mountable Socket		RE48ACV12MW, RE48AML12MW	RUZC3M
Mixed 11–Pin Mountable Socket	Box lug connector	RE48ACV12MW, RE48AML12MW	RE48ASOC11SOLD
Mixed 8–Pin Solder Connector	Solder connectors	RE48ATM12MW, RE48AMH13MW	RE48ASOC8SOLD
Mixed 11–Pin Solder Connector	Solder connectors	RE48ACV12MW, RE48AML12MW	RE48ASOC11SOLD

Table 23.125: Accessories (sold in lots of 10)

Description	Compatibility	Catalog Number
Setting protective cover	RE48 Series Timers	RE48ASETMOV
Protective cover IP64		RE48AIPCOV

Approvals for RE48 Timers



File: E173076
CCN: NRNT2, NRNT8



File: 248382
Class: 3211 07



IEC 61812-1

RoHS Compliant

[2] For detailed function definitions, see Table 23.128.

Zelio™ REXL Miniature Plug-In Timers

The Zelio REXL miniature plug-in timer range is comprised of DPDT and 4PDT single On-delay function timers. The unit is designed to be mounted in a socket in a panel. Thanks to the large selector knob, the user can quickly and easily see the current value selected and change it if needed. Features include:

- Miniature and plug-in (21 x 27 mm / 0.827 x 1.062 in.)
- Single function: function A = delay on energization
- Rated current at 5 A
- 7 timing ranges (0.1 s to 100 h)
- Multivoltage
- Excellent immunity to interference
- Power on and relay energized indication by 2 LEDs



REXL2TM



REXL4TM



RXZE2M114M



RXZE2S114M

Table 23.126: REXL Series Timers

Supply Voltage	Timing Ranges	Pin Configuration	Output Type	Rated Current	Functions	Function Descriptions [3]	Catalog Number
12 Vdc	0.1 s to 100 h	8-Pin Quick Connect (Blade)	DPDT Relay	5 A	A	Power On delay	REXL2TMJD
24 Vdc	0.1 s to 100 h	8-Pin Quick Connect (Blade)	DPDT Relay	5 A	A	Power On delay	REXL2TMBD
24 Vac	0.1 s to 100 h	8-Pin Quick Connect (Blade)	DPDT Relay	5 A	A	Power On delay	REXL2TMB7
120 Vac	0.1 s to 100 h	8-Pin Quick Connect (Blade)	DPDT Relay	5 A	A	Power On delay	REXL2TMF7
230 Vac	0.1 s to 100 h	8-Pin Quick Connect (Blade)	DPDT Relay	5 A	A	Power On delay	REXL2TMP7
12 Vdc	0.1 s to 100 h	14-Pin Quick Connect (Blade)	4PDT Relay	5 A	A	Power On delay	REXL4TMJD
24 Vdc [4]	0.1 s to 100 h	14-Pin Quick Connect (Blade)	4PDT Relay	5 A	A	Power On delay	REXL4TMBD
24 Vac [4]	0.1 s to 100 h	14-Pin Quick Connect (Blade)	4PDT Relay	5 A	A	Power On delay	REXL4TMB7
120 Vac	0.1 s to 100 h	14-Pin Quick Connect (Blade)	4PDT Relay	5 A	A	Power On delay	REXL4TMF7
230 Vac	0.1 s to 100 h	14-Pin Quick Connect (Blade)	4PDT Relay	5 A	A	Power On delay	REXL4TMP7

Table 23.127: Sockets (sold in lots of 10)

Contact Terminal Arrangement	Connection	For Use with Relays	Catalog Number
Mixed	Box lug connector	REXL2TM** REXL4TM**	RXZE2M114M
	Box lug connector	REXL2TM**	RXZES108M
Separate	Box lug connector	REXL4TM**	RXZE2S114M

Approvals for REXL Timers



File: E173076
CCN: NRNT2,
NRNT8



File: 248382
Class: 3211 07



IEC 61812-1

RoHS
Compliant

Table 23.128: Timer Function Description

Function	Function Description [5]	Timer
A	Power on delay relay	RE17, RE48, REXL
A1, A2	Delay on energization	RE48
Ac	On-delay and off-delay relay with control signal	RE17
Ad	Pulse delayed relay with control signal	RE17
At	Power on delay relay (summation) with control signal	RE17
B	Interval relay with control signal	RE17, RE48
Bw	Double interval relay with control signal	RE17
C	Off-delay relay with control signal	RE17, RE48
D	Symmetrical flasher relay (starting pulse off)	RE17
Di	Symmetrical flasher relay (starting pulse on)	RE17, RE48
H	Interval relay	RE17
H1, H2	Pulse-on energization	RE48
Ht	Interval relay (summation) with control signal	RE17
L	Asymmetrical flasher relay (starting pulse off)	RE17, RE48
Li	Asymmetrical flasher relay (starting pulse on)	RE17, RE48
N	Retriggerable interval relay with control signal on	RE17
O	Retriggerable interval delayed relay with control signal on	RE17
P	Pulse delayed relay with fixed pulse length	RE17
Pt	Pulse delayed relay (summation and fixed pulse length) with control signal off	RE17
T	Bistable relay with control signal on	RE17
Tt	Retriggerable bistable relay with control signal on	RE17
W	Interval relay with control signal off	RE17

[3] For detailed function definitions, see Table 23.128.

[4] For 48 Vdc supply, additional resistor 560 ohms 2 W / 24 Vdc. For 48 Vac, additional resistor 390 ohms 4 W / 24 Vac.

[5] See catalog 9050CT0001 for timing diagrams and detailed descriptions.



9050JCK46V20

Square D™ JCK General Purpose Plug-In Timers

Square D 9050JCK timing relays are designed to provide low-cost timing in a plug-in housing. The Types JCK11 through 59 provide ±1% repeat accuracy. The Types JCK60 and 70 offer ±0.1% repeat accuracy. These timers are directly interchangeable with many other 8 and 11 pin octal base timers.

- Up to ±0.1% repeat accuracy
- Timing from 0.05 seconds to 999 hours
- Available in 7 timing modes
- DPDT contacts (2 N.O. and 2 N.C.)
- 10 A contact rating
- Transient protected
- Hold down spring available
- Variable or fixed time delay
- Horsepower rated
- RoHS compliant

Table 23.129: Variable Time Delay

Knob Adjustable Timing Range	On Delay ^[1]	Off Delay ^[2] ^[1]	Off Delay Power Trigger ^[1]	Interval ^[1]	One Shot ^[2] ^[1]	One Shot Power Trigger ^[1]	Repeat Cycle ^[3] ^[1]
0.1–10 seconds	JCK11	JCK21	JCK21PT	JCK31	JCK41	JCK41PT	JCK51
0.3–30 seconds	JCK12	JCK22	JCK22PT	JCK32	JCK42	JCK42PT	JCK52
0.6–60 seconds	JCK13	JCK23	JCK23PT	JCK33	JCK43	JCK43PT	JCK53
1.2–120 seconds	JCK14	JCK24	JCK24PT	JCK34	JCK44	JCK44PT	JCK54
1.8–180 seconds	JCK15	JCK25	JCK25PT	JCK35	JCK45	JCK45PT	JCK55
0.1–10 minutes	JCK16	JCK26	JCK26PT	JCK36	JCK46	JCK46PT	JCK56
0.3–30 minutes	JCK17	JCK27	JCK27PT	JCK37	JCK47	JCK47PT	JCK57
0.6–60 minutes	JCK18	JCK28	JCK28PT	JCK38	JCK48	JCK48PT	JCK58
1.2–120 minutes	JCK19	JCK29	JCK29PT	JCK39	JCK49	JCK49PT	JCK59

Table 23.130: Fixed Time Delay

Timing Mode	Type ^[1] ^[4] ^[5]	Timing Range (seconds)
On Delay	JCK1F(XXXX)	0.1 to 180
		181 to 3600
Off Delay ^[2]	JCK2F(XXXX)	0.1 to 180
		181 to 3600
Off Delay with Power Trigger	JCK2F(XXXX)PT	0.1 to 180
		181 to 3600
Interval	JCK3F(XXXX)	0.1 to 180
		181 to 3600
One Shot ^[2]	JCK4F(XXXX)	0.1 to 180
		181 to 3600
One Shot with Power Trigger	JCK4F(XXXX)PT	0.1 to 180
		181 to 3600
Repeat Cycle	JCK5F(XXXX)	0.1 to 180
		181 to 3600

Table 23.131: Voltage Codes

Voltage	Code
12 Vdc	V36
24 Vac/Vdc	V14
48 Vac/Vdc	V17
120 Vac/110 Vdc	V20
240–50/60 Vac	V24

Table 23.132: How to Order

To Order Specify:	Catalog Number		
	Class	Type	Voltage Code
<ul style="list-style-type: none"> • Class Number • Type Number • Voltage Code 	9050	JCK11	V20

[1] Voltage code must be specified to order this product. Refer to the standard voltage codes listed in Table 23.131 and insert as shown in Table 23.132.

[2] Initiating contact can be up to 50 feet from the timer.

[3] Two dials are provided for independently adjustable repeat cycle timing ranges.

[4] (XXXX) denotes the timing period in seconds.

Example: Class 9050 Type JCK1F60 is an On Delay timer fixed at 60 seconds.

[5] Fixed repeat cycle timers can be supplied with the same or different On-Time and Off-Time.

Type JCK60 and JCK70 Timers

Type JCK60

This On-Delay timer uses four push button thumbwheels to set the time delay. One switch is used for the range. The remaining three are used for the time setting.



9050JCK60V14



9050JCK70V14

Table 23.133: Selection

Timing Modes	Timing Ranges		Type
On Delay	0.01s	0.05–9.99 seconds	JCK60 ^[6]
	0.1s	00.1–99.9 seconds	
	S	001–999 seconds	
	0.1m	00.1–99.9 minutes	
	M	001–999 minutes	
	0.1h	00.1–99.9 hours	
H	001–999 hours		

Type JCK70

This multifunction multirange time delay relay uses five push button thumbwheel switches. Three switches are used for the time delay, one switch is used for the timing range, and the other switch is used to select the timing mode.

Table 23.134: Selection

Timing Modes	Timing Ranges	Type
On Delay Interval Off Delay One Shot Repeat Cycle-Off ^[7] Repeat Cycle-On On/Off Delay 1 Shot Falling Edge Watchdog Trigger On Delay	Same as JCK60	JCK70 ^[6]

Table 23.135: Sockets

Contact Terminal Arrangement	Connection	For Use with Relays	Sold in Lots of	Catalog Number ^[8]
Mixed ^[9]	Screw Connector	JCK11–19 JCK31–39 JCK51–59 JCK60 JCK1 F JCK3 F JCK5 F	1	8501NR51
		JCK21–29 JCK41–49 JCK70 JCK2F JCK4F	10	8501NR51B
		JCK21–29 JCK41–49 JCK70 JCK2F JCK4F	1	8501NR61
		JCK21–29 JCK41–49 JCK70 JCK2F JCK4F	10	8501NR61B
Separate ^[10]	Screw Connector	JCK11–19 JCK31–39 JCK51–59 JCK60 JCK1 F JCK3 F JCK5 F	1	8501NR52
		JCK21–29 JCK41–49 JCK70 JCK2F JCK4F	10	8501NR52B
		JCK21–29 JCK41–49 JCK70 JCK2F JCK4F	1	8501NR62
		JCK21–29 JCK41–49 JCK70 JCK2F JCK4F	10	8501NR62B



8501NR61



8501NR52

Table 23.136: Accessories (sold in lots of 10)

Description	For Use With	Sold in Lots of	Catalog Number
Metal Restraining Strap	8501NR51 sockets	1	8501NH7
	8501NR52 sockets		
	8501NR61 sockets		
	8501NR62 sockets		



8501NH7

Approvals for 9050JCK Timers

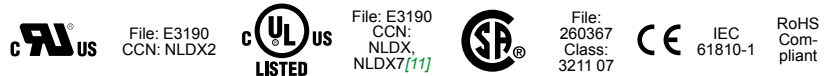

[6] Voltage code must be specified to order this product. Refer to the standard voltage codes listed in Table 23.131 and insert as shown in Table 23.132.
 [7] The repeat cycle mode uses the same on-time and off-time.
 [8] Please note that the B suffix only designates quantities of 10 and is not printed on the socket.
 [9] The inputs and outputs are mixed on both sides.
 [10] The inputs and outputs are on separate sides.
 [11] When used with the appropriate 8501NR socket.

New!

Zelio™ RTC48 Temperature Controllers

The cost-effective Zelio RTC48 temperature controllers combine simplicity, performance, and value. With the Modbus open communication option, they easily interface with solid-state relays, plug-in relays, tower lights, PLCs, and HMIs. The units' three color, 5-digit LED display intelligently adapts to any variation in the process value and can be easily read from a distance. The free configuration software simplifies setup via USB connection to any laptop or PC. These temperature controllers are indispensable in the execution of critical processes, such as in food and beverage, extrusion equipment, injection machines, mold presses, thermo-forming, and horticulture and livestock facilities. The Zelio RTC48 offer comprises a standard 48 x 48 mm (1/16-inch DIN) format and provides the optimal balance of price and functionality, featuring the desirable PID control with auto-tuning, outputs, and alarms.

Key features include:

- PID control algorithm with auto-tuning function
- Universal input types
- Adaptive display
- Modbus communication for easy data exchange with other automation products
- Optional programming cable for use with Zelio Temperature Control Soft configuration software



RTC48PUN1RNLU



RTCCBL



RTCCOV



RTCACC

Table 23.137: Catalog Numbers

Input Type	Supply Voltage	Output 1	Output 2	Alarms	Communication on Modbus	Catalog Number
Thermo-couple: J, K, R, B, S, T, E, N, PL-2, C (W/Re 5-26)	110–240 Vac	Relay	–	1	–	RTC48PUN1RNHU
		SSR	–	1	–	RTC48PUN1SNHU
		Relay	–	1	RS485	RTC48PUNCRNHU
		SSR	–	1	RS485	RTC48PUNCSNHU
		Relay	Relay	1	–	RTC48PUN1RRHU
		SSR	Relay	1	–	RTC48PUN1SRHU
		Relay	–	2	–	RTC48PUN2RNHU
		SSR	–	2	–	RTC48PUN2SNHU
		Relay	Relay	1	RS485	RTC48PUNCRRHU
		SSR	Relay	1	RS485	RTC48PUNCSRHU
		Relay	SSR	1	–	RTC48PUN1RSHU
		SSR	SSR	1	–	RTC48PUN1SSHU
RTD: Pt100, JPt100, 3-wire system	110–240 Vac	Relay	–	1	–	RTC48PUN1RNLU
		SSR	–	1	–	RTC48PUN1SNLU
		Relay	–	1	RS485	RTC48PUNCRNLU
		SSR	–	1	RS485	RTC48PUNCSNLU
		Relay	Relay	1	–	RTC48PUN1RRLU
		SSR	Relay	1	–	RTC48PUN1SRLU
		Relay	–	2	–	RTC48PUN2RNLU
		SSR	–	2	–	RTC48PUN2SNLU
		Relay	Relay	1	RS485	RTC48PUNCRRLU
		SSR	Relay	1	RS485	RTC48PUNCSR LU
		Relay	SSR	1	–	RTC48PUN1RSLU
		SSR	SSR	1	–	RTC48PUN1SSLU
DC Current: 0–20 mA, 4–20 mA	24 Vac/Vdc	Relay	–	1	–	RTC48PUN1RNLU
		SSR	–	1	–	RTC48PUN1SNLU
		Relay	–	1	RS485	RTC48PUNCRNLU
		SSR	–	1	RS485	RTC48PUNCSNLU
		Relay	Relay	1	–	RTC48PUN1RRLU
		SSR	Relay	1	–	RTC48PUN1SRLU
DC Voltage: 0–1 Vdc, 0–5 Vdc, 1–5 Vdc, 0–10 Vdc	24 Vac/Vdc	Relay	–	2	–	RTC48PUN2RNLU
		SSR	–	2	–	RTC48PUN2SNLU
		Relay	Relay	1	RS485	RTC48PUNCRRLU
		SSR	Relay	1	RS485	RTC48PUNCSR LU
		Relay	SSR	1	–	RTC48PUN1RSLU
		SSR	SSR	1	–	RTC48PUN1SSLU
DC Voltage: 0–1 Vdc, 0–5 Vdc, 1–5 Vdc, 0–10 Vdc	24 Vac/Vdc	Relay	–	1	–	RTC48PUN1RNLU
		SSR	–	1	–	RTC48PUN1SNLU
		Relay	–	1	RS485	RTC48PUNCRNLU
		SSR	–	1	RS485	RTC48PUNCSNLU
		Relay	Relay	1	–	RTC48PUN1RRLU
		SSR	Relay	1	–	RTC48PUN1SRLU

Table 23.138: RTC48 Temperature Controller Accessories

Catalog Number	Description	For Use with Temperature Controllers
RTCCBL	USB Communications Cable	RTC48*****
RTCCOV	Terminal Cover	
RTCACC	Spare Parts Pack (Gasket, Shunt and Mounting Frame)	

Approvals for RTC48 Temperature Controllers



File: E327516
CCN: XAPX2



File: 257850
Class: 4813 02



RoHS Compliant

Zelio™ REG Temperature Controllers

Zelio REG temperature controllers offer seamless interfacing with solid state relays, electromechanical relays, PLCs, variable speed drives and HMI displays make them a key component to controlling the temperature in your process.

Offer includes 3 versions:

- A 24x48 mm (1/32 DIN) cost effective solution for basic temperature control needs.
- A 48x48 mm (1/16 DIN) balanced version for optimal price and functionality.
- A 96x48 mm (1/8 DIN) full-featured version for complete performance and function.

Key features include:

- Modbus communication for easy data exchange with other automation products
- Simple parameter settings
- IP66 certification enables dust resistance
- Flash memory (saves configurations)
- Compatible with a wide range of sensors
- Advanced Functions (standard): PID, fuzzy logic, auto-tuning, soft start
- Optimized programming
 - Common software for all products in the temperature relay range (freely downloadable from www.schneider-electric.us).
 - A single cable enables connection to both a computer and PLCs.
 - Simple adjustment of parameters.
 - Saving of configurations.



REG24PTP1RHU



REG48PUN1RHU

Table 23.139: Zelio Temperature Controllers—24 x 48 Size — 1/32 DIN Standard

Input Type	Supply Voltage	Output 1	Output 2	Alarms	Comm. on Modbus	Catalog Number
Thermocouple: J,K,R,B,S,T, E,N,PL2, RTD: PT100	100/240 Vac	Relay	–	–	Yes	REG24PTP1RHU
		Relay	–	1	Yes	REG24PTP1ARHU
		SSR	–	–	Yes	REG24PTP1LHU
		SSR	–	1	–	REG24PTP1ALHU
24 Vac/Vdc	Relay	–	–	Yes	REG24PTP1RLU	
	SSR	–	–	Yes	REG24PTP1LLU	
DC Voltage: 1–5 Vdc, 0–5 Vdc, 0–10 Vdc, 2–10 Vdc, 0–100 mVdc	100/240 Vac	Relay	–	–	Yes	REG24PUJ1RHU
		SSR	–	–	Yes	REG24PUJ1LHU
		Relay	–	–	Yes	REG24PUJ1RLU
DC Current: 0–20 mA, 4–20 mA	24 Vac/Vdc	SSR	–	–	Yes	REG24PUJ1LLU

Table 23.140: Zelio Temperature Controllers—48 x 48 Size — 1/16 DIN Standard

Input Type	Supply Voltage	Output 1	Output 2	Alarms	Comm. on Modbus	Catalog Number
Thermocouple: J,K,R,B,S,T, E,N,PL2, RTD: PT100,	100/240 Vac	Relay	–	2	Yes	REG48PUN1RHU
		Relay	–	2	–	REG48PUN1LRHU
		Relay	Relay	2	Yes	REG48PUN2RHU
		SSR	SSR	2	Yes	REG48PUN1LHU
		SSR	SSR	2	–	REG48PUN1LHU
		SSR	Relay	2	Yes	REG48PUN2LRHU
		Analog (4-20 mA)	–	2	Yes	REG48PUN1JHU
DC Voltage: 1–5 Vdc, 0–5 Vdc, 0–10 Vdc, 2–10 Vdc, 0–100 mVdc	24 Vac/Vdc	SSR	Analog (4-20 mA)	2	Yes	REG48PUN2LJHU
		Relay	–	2	Yes	REG48PUN1RLU
		Relay	Relay	2	Yes	REG48PUN2RLU
		Relay	–	2	Yes	REG48PUN1LLU
		SSR	Relay	2	Yes	REG48PUN2LRLU
		Analog (4-20 mA)	–	2	Yes	REG48PUN1JLU
DC Current: 0–20 mA, 4–20 mA	24 Vac/Vdc	SSR	Analog (4-20 mA)	2	Yes	REG48PUN2LJLU



REG96PUN1RHU

Table 23.141: Zelio Temperature Controllers—96 x 48 Size — 1/8 DIN Standard

Input Type	Supply Voltage	Output 1	Output 2	Alarms	Comm. on Modbus	Catalog Number
Thermocouple: J,K,R,B,S,T, E,N,PL2	100/ 240 Vac	Relay	–	3	Yes	REG96PUN1RHU
		Relay	–	3	–	REG96PUNL1RHU
		Relay	Relay	3	Yes	REG96PUN2RHU
		SSR	–	3	Yes	REG96PUN1LHU
		SSR	–	3	–	REG96PUNL1LHU
		SSR	Relay	3	Yes	REG96PUN2LRHU
RTD: PT100	100/ 240 Vac	Analog (4-20 mA)	–	3	Yes	REG96PUN1JHU
		SSR	Analog (4-20 mA)	3	Yes	REG96PUN2LJHU
DC Voltage: 1–5 Vdc, 0–5 Vdc, 0–10 Vdc, 2–10 Vdc, 0–100 mVdc	24 Vac/ Vdc	Relay	–	3	Yes	REG96PUN1RLU
		Relay	Relay	3	Yes	REG96PUN2RLU
		SSR	–	3	Yes	REG96PUN1LLU
		SSR	Relay	3	Yes	REG96PUN2LRLU
		Analog (4-20 mA)	–	3	Yes	REG96PUN1JLU
		Analog (4-20 mA)	SSR	3	Yes	REG96PUN2LJLU
DC Current: 0–20 mA, 4–20 mA	24 Vac/ Vdc	Relay	–	3	Yes	REG96PUN1RLU
		Relay	Relay	3	Yes	REG96PUN2RLU
DC Current: 0–20 mA, 4–20 mA	24 Vac/ Vdc	SSR	–	3	Yes	REG96PUN1LLU
		SSR	Relay	3	Yes	REG96PUN2LRLU
DC Current: 0–20 mA, 4–20 mA	24 Vac/ Vdc	Analog (4-20 mA)	–	3	Yes	REG96PUN1JLU
		Analog (4-20 mA)	SSR	3	Yes	REG96PUN2LJLU

Table 23.142: Temperature Controller Accessories

Description	For Use with Relays	Sold in Lots Of	Catalog Number
Bracket for mounting on DIN rail	24 x 48 mm (1/32 DIN)	4	REG24PSOC
	48 x 48 mm (1/16 DIN)	2	REG48PCOV
Terminal block cover	48 x 48 mm (1/16 DIN)	2	REG48PCOV
	96 x 48 mm (1/8 DIN)	2	REG96COV

Approvals for Zelio REG Temperature Controllers



File: E327516
CCN: XAPX2



File: 245853
Class: 4813 02



RoHS
Compliant

Zelio™ Current Measurement Relays

Zelio Current Measurement Relays are designed to measure under and overcurrent conditions, without external sensors. Current measurement relays enable continuous monitoring of the operation of electrical and mechanical loads such as motors and heaters. They are DIN rail mountable and the control status is indicated by an LED.

RM17JC Current Control Relay

- Monitors AC currents
- Designed to monitor overcurrent
- Equipped with an integrated current transformer

RM35JA Current Control Relays

- Selection between overcurrent or undercurrent
- Automatic DC or AC recognition
- Selectable memory function



RM17JC00MW



RM35JA31MW



RM35JA32MW

Table 23.143: Zelio Current Measurement Relays

Supply Voltage	Measurement Range		Output 5 A	Width		Catalog Number
	Range ^[1]	Terminals		Inches	mm	
24–240 Vac/dc	2–20 A	N/A	1 C/O	0.69	17.50	RM17JC00MW
	2–20 mA	E1-M	2 C/O	1.38	35.00	RM35JA31MW
	10–100 mA	E2-M				
	50–500 mA	E3-M				
	0.15–1.5 A	E1-M				
	0.5–5 A	E2-M				
1.5–15 A	E3-M	RM35JA32MW				

Table 23.144: Output Characteristics and Measurement Circuit Characteristics

Type of Relay	RM17JC00MW	RM35JA31MW	RM35JA32MW
Setting accuracy	Plus or minus 10% of the full scale value		
Repeat accuracy (with constant parameters)	Plus or minus 0.5%		
Hysteresis	15% of the threshold setting, fixed	5 to 50% of the threshold setting, adjustable	
Time delay accuracy (with constant parameters)	N/A	Plus or minus 2%	
Time delay on pick-up	500 ms	300 ms	
Conforming to standards	NF EN 60255-6		
Ambient air temperature around the device	Storage	-40 to 158 degrees F (-40 to +70°C)	
	Operational	-4 to 122 degrees F (-20 to +50°C)	

Approvals for Zelio Current Measurement Relays



File: E173076
CNN: NRNT,
NRNT7



File: 248382
Class: 3211 07



CE: 73/23/EEC
and EMC 89/
336/EEC

GL, C-Tick,
GOST, RoHS

Approximate Dimensions

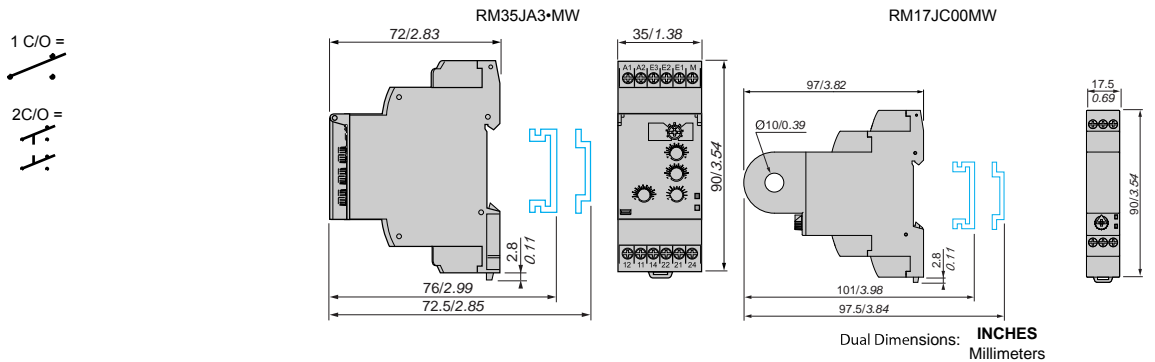

[1] Above 15 A, a current transformer can be connected (for RM35JA3-MW). See page 57 of catalog 8430CT0601 for suggested wiring.

Zelio™ Phase Measurement Relays

Zelio Phase Measurement Relays monitor their own power supply. Relay status is indicated by an LED and they are DIN rail mountable.

RM17TG-0 measurement and control relays are for monitoring of 3-phase supplies for the correct sequencing of phases L1, L2, and L3, as well as the total loss of one or more phases.



RM17TG-0

Table 23.145: 3-Phase Supply Control Relays

Supply Voltage	Detection Threshold	Output 5 A	Width		Catalog Number
			inches	mm	
208–480 Vac	<100 Vac	1 C/O	0.69	17.50	RM17TG00
208–440 Vac		2 C/O			RM17TG20

Table 23.146: Multifunction 3-Phase Supply Control Relays

Supply Voltage	Voltage Range	Output 5 A	Width		Catalog Number
			inch	mm	
208–480 Vac	Selectable voltages: 208, 220, 380, 400, 415, 440, 480	1 C/O	0.69	17.50	RM17TT00
					RM17TA00
					RM17TU00
					RM17TE00

Table 23.147: RM17TT, RM17TA, RM17TU, and RM17TE Multifunction Control Relays monitor the following on 3-phase supplies:

Function	RM17TT	RM17TA	RM17TU	RM17TE
Sequence of phases L1, L2 and L3	Yes	Yes	Yes	Yes
Phase failure with regeneration (0.7 x selected voltage range)	Yes	Yes	Yes	Yes
Asymmetry (phase imbalance)	No	Yes	No	Yes
Undervoltage	No	No	Yes	No
Overvoltage and undervoltage	No	No	No	Yes

Table 23.148: 3-Phase Supply and Motor Temperature Control Relays

Supply Voltage	Measurement Range	Output 5 A	Width		Catalog Number
			inch	mm	
220–480 Vac	208–480 Vac	2 N.O.	1.38	35.00	RM35TM50MW
					RM35TM250MW

Table 23.149: RM35TM Control Relays monitor the following on 3-phase supplies:

Function	RM35TM50MW	RM35TM250MW
Sequence of phases L1, L2 and L3	Yes	Yes
Phase failure	Yes	Yes
Motor temperature via PTC probe	Yes	Yes
Selection (with or without memory)	No	Yes
Test-reset button	No	Yes

RM35TF30 measurement and control relay is for monitoring of phase sequence, phase failure, asymmetry, undervoltage and overvoltage in window mode.

Table 23.150: Multifunction 3-Phase Supply Control Relays

Supply Voltage	Measurement Range	Output 5 A	Width		Catalog Number
			inch	mm	
220–480 Vac	194–528 Vac	2 C/O	1.38	35.00	RM35TF30



RM17TE00



RM17TA00



RM35TM+MW



RM35TF30

Approvals for Zelio Phase Measurement Relays



File: E173076
CNN: NRNT,
NRNT7



File: 248382
Class: 3211 07



CE: 73/23/EEC
and EMC 89/
336/EEC

GL, C-Tick,
GOST, RoHS

Approximate Dimensions

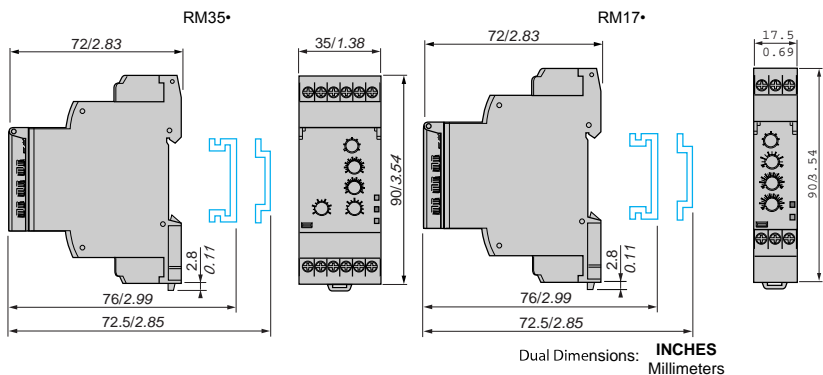
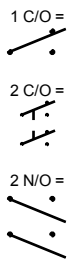

Zelio™ Voltage Measurement Relays

Zelio Voltage Measurement Relays are DIN rail mountable and relay status is indicated by an LED. Single phase and DC voltage measurement and control relays RM17UAS** and RM17UBE** monitor:

- Overvoltage
- Undervoltage
- Overvoltage and undervoltage
- Nominal voltages



RM17UB310

RM17UAS**

Table 23.151: Single-phase and DC voltage control relays

Supply Voltage	Ranges Controlled	Output 5 A	Width		Catalog Number
			in.	mm	
12 Vdc	9–15 Vdc	1 C/O	0.69	17.50	RM17UAS14[2]
24–48 Vac/Vdc	20–80 Vac/Vdc				RM17UAS16[2]
110–240 Vac/Vdc	65–260 Vac/Vdc				RM17UAS15[2]
24–48 Vac/Vdc	20–80 Vac/Vdc				RM17UBE16[3]
110–240 Vac/Vdc	65–260 Vac/Vdc				RM17UBE15[3]

Multifunction voltage control relays RM35UA1•MW monitor both AC and DC voltages.

- Automatic Vdc or Vac recognition
- Selection between overvoltage and undervoltage

Table 23.152: Multifunction voltage control relays

Supply Voltage	Measurement Range		Output 5 A	Width		Catalog Number
	Range[4]	Terminals		in.	mm	
24–240 Vac/Vdc	0.05–0.5 V	E1-M	2 C/O	1.38	35.00	RM35UA11MW
	0.3–3 V	E2-M				
	0.5–5 V	E3-M				
	1–10 V	E1-M				RM35UA12MW
	5–50 V	E2-M				
	10–100 V	E3-M				
	15–150 V	E1-M				
	30–300 V	E2-M				
	60–600 V	E3-M				



RM35UA1•MW

3-phase voltage control relays monitor:

- Failure of one or more phases
- Voltage between phases
- Absence of neutral
- Voltage between phases and neutral
- Overvoltage and undervoltage

Table 23.153: Three-phase voltage control relays

Rated 3-Phase Supply Voltage Vac	Measurement Range	Output 5 A	Width		Catalog Number
			in.	mm	
220–480 phase-phase	195–528 Vac	1 C/O + 1 C/O 1 per threshold	1.38	35.00	RM35UB330[5]
120–277 phase-neutral	183–528 Vac	1 C/O	0.69	17.50	RM17UB310[5]
120–277 phase-neutral	114–329 Vac	1 C/O + 1 C/O 1 per threshold	1.38	35.00	RM35UB3N30[4]



RM35UB3...

Approvals for Zelio Voltage Measurement Relays



File: E173076
CNN: NRNT, NRNT7



File: 248382
Class: 3211 07



CE 73/23/EEC
and EMC 89/336/EEC

GL, C-Tick, GOST, RoHS

Approximate Dimensions

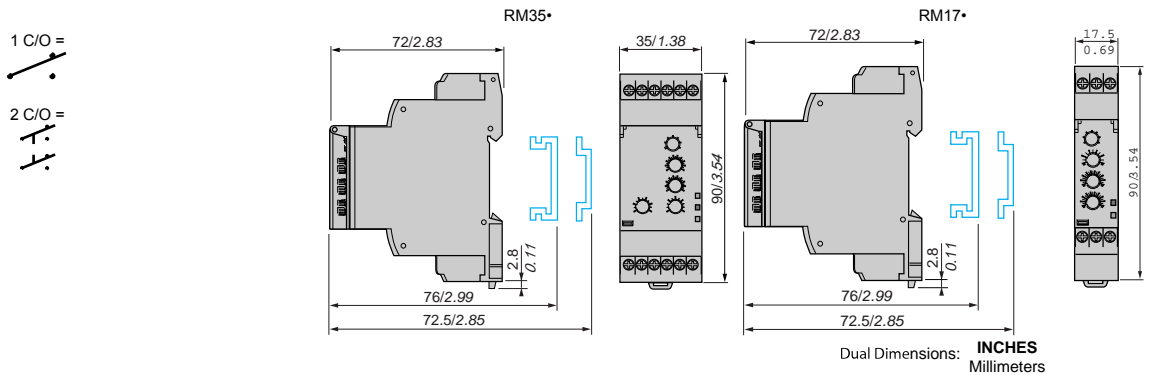

[2] Provides overvoltage or undervoltage protection.
 [3] Provides overvoltage and undervoltage protection in window mode.
 [4] Provides overvoltage and undervoltage protection between phases and neutral and absence of neutral.
 [5] Provides overvoltage and undervoltage protection between phases.



RM35LM33MW



RM35LV14MW



RM79696043



LA9RM201



RM79696006



Zelio™ Level Control Relays and Zelio™ Pump Control Relays

Zelio level control relays control one or two levels with fill or empty function. The settings are protected by a sealable cover, control status is indicated by an LED, and they are DIN rail mountable. RM35LM is designed to control levels of conductive liquid, and RM35LV is designed to control levels of other materials.

Application examples for RM35LM:

- Detecting pump seal failures
- Spring, town, industrial and sea water
- Metallic salt, acid or base solutions
- Liquid fertilizers
- Non-concentrated alcohol (<40%)

Application examples for RM35LV:

- Liquids in the food-processing industry: milk, beer, coffee, etc.
- Chemically pure water
- Fuels, liquid gasses (inflammable)
- Oil, concentrated alcohol (>40%)
- Ethylene, glycol, paraffin, varnish and paints

Table 23.154: Level Control Relays

Time Delay on Crossing the Threshold	Function	Output Relay	Supply Voltage 50/60 Hz	Measurement Ranges	Catalog Number
0.1–5 seconds, 0 + 10%	Detection by resistive probes	2 C/O, 5 A	24–240 Vac/Vdc	250–5 k	RM35LM33MW
				5 k–100 k	
	Detection by discrete sensors	1 C/O, 5 A		50 k–1 M	RM35LV14MW
				—	

Table 23.155: Probes

Application	No. of probes	Operating temperature		Max. Pressure kg/cm ²	Catalog Number
		°F	°C		
Recommended for drink vending machines and where installation space is limited (stainless steel) ^[6]	3	176	80	2	RM79696044
Suitable for boilers, pressure vessels, and under high temperature conditions (1) (304 stainless steel) ^[6]	1	392	25	200	RM79696014

Table 23.156: Probes

Description	Catalog Number
Protected probe for mounting by suspension, protective shell PUC (S7) Electrode: stainless steel	RM79696043
Liquid level control probe, suspended by cable, maximum operating temperature 212 °F (100 °C) ^[7]	LA9RM201

Table 23.157: Electrode Holders

Description	Material	Catalog Number
Electrode for use up to 662°F (350°C)	Stainless steel isolated by ceramic	RM79696006

[6] 3/8 in. BSP mounting thread with hexagonal head. Use a 24 mm spanner for tightening.

[7] 3/8 in. BSP mounting head.



RM35BA10

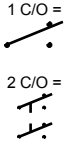

Pump Control Relay

Zelio pump control relay RM35BA10 can operate on a single-phase or 3-phase supply. It incorporates three functions in a signal unit:

- Over and under current measurement
- Phase presence control
- Single or three phase

It has two operating modes which are designed to control a pump via two external signal inputs (Y1 Y2). These two signals are controlled by volt-free contacts. Control inputs Y1 and Y2 can be connected to:

- Level sensor
- Level relay
- Pressure sensor
- Push button

Table 23.158: Pump Control Relay

Description	Current Range Controlled	Supply Voltage	Output	Catalog Number
Pump Control Relay	1–10 A	208–480 Vac, 3 phase	1 C/O 5 A	RM35BA10
		230, single-phase		

Approvals for Zelio Level Control and Pump Control Relays



File: E173076
CNN: NRNT,
NRNT7



File: 248382
Class: 3211 07



CE 73/23/EEC
and EMC 89/
336/EEC

GL, C-Tick,
GOST, RoHS

Approximate Dimensions (mm/in.)

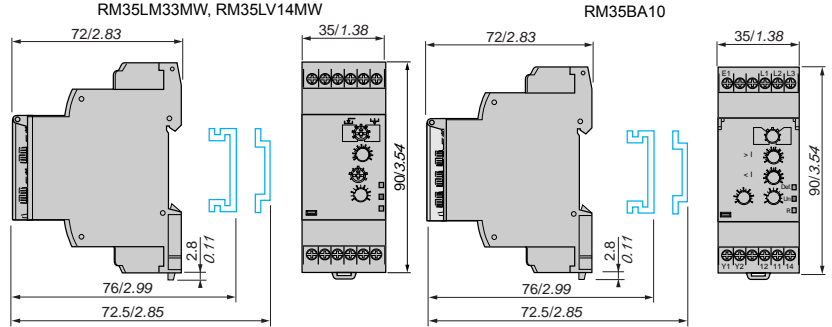

Zelio™ Speed Control Relays, Frequency Control Relays, and Temperature Control Relays

Zelio speed control relay RM35SOMW monitors underspeed and overspeed conditions, with or without memory, with inhibition by an external contact. It operates with either N.O. or N.C. sensors. Adjustable time between impulses is 0.05 s to 10 min. Power-on inhibition time is adjustable from 0.6 to 60 s. Inhibition is controlled by an external contact. Settings are protected by a sealable cover, control status is indicated by an LED, and it is DIN rail mountable.



RM35SOMW

Table 23.159: Speed Control Relay

Function	Time Delay	Measurement Input	Supply	Out-put	Catalog Number
Under-speed	0.05 s to 10 min	3-wire PNP or NPN proximity sensor	24–240 Vac/ Vdc	1 C/O 5A	RM35S0MW
Over-speed		Namur type proximity sensor 0–30 V voltage Volt-free contact			

Zelio frequency control relay RM35HZ monitors its own supply voltage. Settings are protected by a sealable cover, control status is indicated by an LED, and it is DIN rail mountable.



RM35HZ21FM

Table 23.160: Frequency Control Relay

Function	Controlled	Supply Voltage	Output	Catalog Number
Over frequency and under frequency (50 or 60 Hz)	40–60 Hz (50 Hz) / 50–70 Hz (60 Hz)	120–277 Vac	1 C/O + 1 C/O 5A	RM35HZ21FM

Zelio temperature control relays are designed for monitoring the temperature in elevator (lift) rooms, in compliance with directive EN81. For use with PT100 input (customer supplied). Features adjustable control, control status indicated by an LED, and is DIN rail mountable.



RM35AT0MW

Table 23.161: Temperature Control Relays

Function	Supply Voltage	Vac	Output	Catalog Number
Over temperature 93 to 114°F (34 to 46°C)	24–240 Vac/Vdc	—	1 C/O 5A	RM35ATL0MW
Under temperature 30 to 51°F (-1 to 11°C)		—	2 N.O. 5A	RM35ATR5MW
Over temperature 93 to 114 °F (34 to 46°C)		208–480 Vac	2 N.O. 5A	RM35ATW5MW
Under temperature 30 to 51°F (-1 to 11°C)				
Phase sequence				
Phase failure				

Approvals for Zelio Speed, Frequency, and Temperature Control Relays



File: E173076
CNN: NRNT,
NRNT7



File: 248382
Class: 3211 07



CE: 73/23/EEC
and EMC 89/
336/EEC

GL, C-Tick,
GOST, RoHS

Approximate Dimensions (mm/in.)

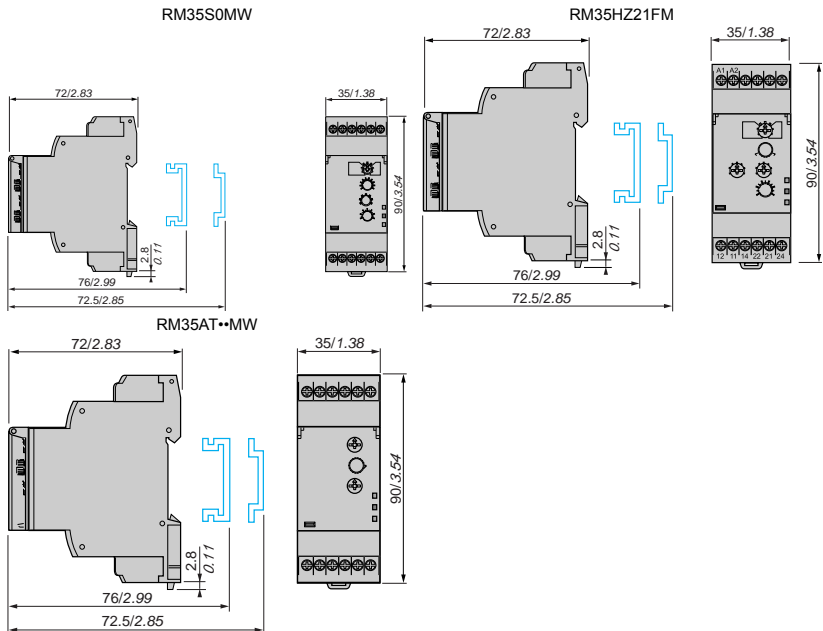
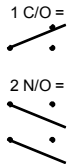



ABL8MEM12020

ABL8REM24030

Phaseo™ DC Power Supply

Phaseo switch mode power supplies are totally electronic and their output voltage is regulated. They offer:

- Compact size
- High degree of output voltage stability

For use with Universal power supplies, see optional function modules in catalog [DIA3ED207041EN-US](#), which offer a set of solutions to meet the needs for continuity of service such as:

- Immunity to microbreaks
- Voltage holding during power outages
- Voltage holding during power supply equipment failure

Table 23.162: Modular, Single Phase

Input Voltage (Vac)	Output Voltage (Vdc)	Nominal Current (I)	Protection Reset	Catalog Number
100–240	5	4	Auto	ABL8MEM05040
	12	2		ABL8MEM12020
	24	0.3		ABL8MEM24003
		0.6		ABL8MEM24006
		1.2		ABL8MEM24012
		2.5		ABL7RM24025

Table 23.163: Optimum, Single Phase

Input Voltage (Vac)	Output Voltage (Vdc)	Nominal Current (I)	Protection Reset	Catalog Number
100–240	12	5	Auto	ABL7RP1205
	24	3		ABL8REM24030
	5	ABL8REM24050		
	2.5	ABL7RP4803		

Table 23.164: Universal, Single Phase

Input Voltage (Vac)	Output Voltage (Vdc)	Nominal Current (I)	Auto-Protection Reset	Catalog Number
100–120 / 200–500	24	3	Auto/Manual	ABL8RPS24030
		5		ABL8RPS24050
		10		ABL8RPS24100
100–120 / 200–240	20	ABL8RPM24200		

Table 23.165: Universal, Three Phase

Input Voltage (Vac)	Output Voltage (Vdc)	Nominal Current (I)	Auto-Protection Reset	Catalog Number
380–500	24	20	Auto/Manual	ABL8WPS24200
		40		ABL8WPS24400

Table 23.166: Dedicated, Single Phase

Input Voltage (Vac)	Output Voltage (Vdc)	Nominal Current (I)	Protection Reset	Catalog Number
100–240 ^[1]	12	5	Auto	ABL1REM12050
	24	2.5		ABL1REM24025
100–120 / 200–240 ^[2]	24	4.2		ABL1REM24042
	24	6.2		ABL1REM24062
100–240 ^[1]	12	8.3	Auto	ABL1RPM12083
	24	4.2		ABL1RPM24042
100–120 / 200–240 ^[2]	24	6.2		ABL1RPM24062
	24	10		ABL1RPM24100



ABL8RPS24100

ABL8WPS24200

ABL1RPM24042

ABL1RPM24100

Approvals for Phaseo DC Power Supply



File: E164867
CCN: NMTR, NMTR7



File: E164867
CCN: NMTR2, NMTR8



File: 238438
Class: 5311-87, 5311-07



RoHS Compliant

- SEMI F47 Compliant for most units
- For additional information, refer to Catalog [DIA3ED207041EN-US](#).

[1] Compatible input voltage 120-370 Vdc not indicated on the product.
[2] Compatible input voltage 180-370 Vdc not indicated on the product.

Zelio™ Analog Interface Modules

The Zelio Analog range of converters is designed to convert signals emitted by sensors or electrical measurement devices into standard electrical signals that are compatible with automation platforms and controllers. They also allow the connection distance between a sensor and a measurement device to be increased, for example, between a thermocouple and a programmable controller

Table 23.167: Converters for Type J and K thermocouples—supply voltage 24 Vdc ± 20%, non-isolated

Type	Temperature Range		Switchable Output Signals	Catalog Number
	°F	°C		
Type J	32–302	0–150	0–10 V, 0–20 mA, 4–20 mA	RMTJ40BD
	32–572	0–300	0–10 V, 0–20 mA, 4–20 mA	RMTJ60BD
	32–1112	0–600	0–10 V, 0–20 mA, 4–20 mA	RMTJ80BD
Type K	32–1112	0–600	0–10 V, 0–20 mA, 4–20 mA	RMTK80BD
	32–2192	0–1200	0–10 V, 0–20 mA, 4–20 mA	RMTK90BD

Table 23.168: Converters for Universal Pt100 probes—supply voltage 24 Vdc ± 20%, non-isolated

Type	Temperature Range		Switchable Output Signals	Catalog Number
	°F	°C		
Pt100 2-wire, 3-wire, and 4-wire	- 40–104	- 40–40	0–10 V, 0–20 mA, 4–20 mA	RMPT10BD
	- 148–212	- 100–100	0–10 V, 0–20 mA, 4–20 mA	RMPT20BD
	32–212	0–100	0–10 V, 0–20 mA, 4–20 mA	RMPT30BD
	32–482	0–250	0–10 V, 0–20 mA, 4–20 mA	RMPT50BD
	32–932	0–500	0–10 V, 0–20 mA, 4–20 mA	RMPT70BD

Table 23.169: Converters for Optimum Pt100 probes^[1]—supply voltage 24 Vdc ± 20%, non-isolated

Type	Temperature Range		Switchable Output Signals	Catalog Number
	°F	°C		
Pt100 2-wire, 3-wire, and 4-wire	- 40–104	- 40–40	0–10 V or 4–20 mA	RMPT13BD
	- 148–212	- 100–100	0–10 V or 4–20 mA	RMPT23BD
	32–212	0–100	0–10 V or 4–20 mA	RMPT33BD
	32–482	0–250	0–10 V or 4–20 mA	RMPT53BD
	32–932	0–500	0–10 V or 4–20 mA	RMPT73BD

Table 23.170: Universal Voltage/Current Converters

Type	Input Signal	Output Signal	Catalog Number
Supply voltage 24 Vdc ± 20%, non-isolated	0–10 V or 4–20 mA	0–10 V or 4–20 mA	RMCN22BD
Supply voltage 24 Vdc ± 20%, isolated	0–10 V, ± 10 V, 0–20 mA, 4–20 mA	Switchable: 0–10 V, ± 10 V, 0–20 mA, 4–20 mA	RMCL55BD
	0–50 V, 0–300 V, 0–500 V DC or AC, 50/60 Hz	Switchable: 0–10 V, 0–20 mA, 4–20 mA	RMCV60BD
	0–1.5 A, 0–5 A, 0–15 A DC or AC, 50/60 Hz	0–10 V, 0–20 mA, 4–20 mA	RMCA61BD

Approvals for Zelio Analog Interface Modules



File: E164353
CCN: NKCR



File: 044087_S_000
Class: 32T1 07



IEC
60947-1

RoHS
Compliant

Table 23.171: How to Order

To Order Specify:	Catalog Number
• Catalog Number	RMCN22BD



RMTJ40BD



RMTK90BD



RMPT70BD



RMPT13BD



RMCN22BD

[1] Converters dedicated to Zelio Logic smart relays.



ABS2EA02EM



ABS2SA01MB

Solid State Interface Modules

ABS solid state relay interface modules are for discrete digital input or output control signals exchanged in automated equipment. Features include:

- High operating rate
- 5 separate character places for marking
- Silent operation
- LED indication of the control signal state
- 35 mm DIN 3 or 32 mm DIN 1 track mountable

Table 23.172: Solid State Interface Input Modules

	Input Module Catalog Number				
Input Module Catalog No.	ABS2EC01EA	ABS2EC01EB	ABS2EC01EE	ABS2EA02EF	ABS2EA02EM
Dimensions (WxDxH)[2]	Inches: 0.37 x 2.78 x 2.91			mm: 9.5 x 70.5 x 74	
Control Circuit Characteristics					
Rated Voltage US	5 Vdc	24 Vdc	48 Vdc	120/127 60Hz	230/240 60Hz
Maximum Voltage	6 (TTL)	28.8 Vdc	57.6 Vdc	140 Vac	264 Vac
Maximum Current at Us	13.6 mA	12 mA	10.5 mA	17 mA	15 mA
Internal Protection Against Reverse Polarity	Yes	Yes	Yes	N/A	N/A
Output Circuit Characteristics					
Rated Operational Voltage Ve	5 to 48 Vdc	5 to 48 Vdc	5 to 48 Vdc	5 to 48 Vdc	5 to 48 Vdc
Min./Max. Voltage	2/60 Vdc	2/60 Vdc	2/60 Vdc	2/60 Vdc	2/60 Vdc
Min./Max. Switching Current	1/50 mA	1/50 mA	1/50 mA	1/50 mA	1/50 mA
Rated Insulation Voltage	Conforming to IEC 60947-1: 300 V Conforming to IEC 0110: 250 V group C				
Approvals	UL E164353, CSA 044087_S_000, IEC 60947-1				

Table 23.173: Solid State Interface Output Modules

	Output Module Catalog Number			
	ABS2SC01EB	ABS2SC02EB	ABS2SA01MB	ABS2SA02MB
Dimensions (W x D x H) [2]	Inches: 0.69 x 2.78 x 2.91		mm: 17.5 x 70.5 x 74	
Control Circuit Characteristics				
Rated Voltage Us	24 Vdc	24 Vdc	24 Vdc	24 Vdc
Maximum Voltage	28.8 Vdc	28.8 Vdc	28.8 Vdc	28.8 Vdc
Maximum Current at Us	12 mA	12 mA	13.6 mA	13.6 mA
Internal Protection against reverse polarity	Yes	Yes	Yes	Yes
Output Circuit Characteristics				
Rated Operational Voltage Ve	5 to 48 Vdc	5 to 48 Vdc	24 to 240 Vac	24 to 240 Vac
Maximum Voltage	57.6 Vdc	57.6 Vdc	264 Vac	264 Vac
Internal Protection against reverse polarity	Yes	Yes	Yes	Yes
External Protection	3.15 A external fuse fast blow (Ik <= 1 kA AC and Ik <= 100 A DC)			
Rated insulation voltage	Conforming to IEC 60947-1: 300 V Conforming to VDE 0110: 250 V group C			
Approvals	UL E164353, CSA 044087_S_000, IEC 60947-1			

- For Mounting Track, see [Mounting Track, End Clamps, Jumpers, Fanning Strips](#), page 24-19.

Table 23.174: How to Order

To Order Specify:	Catalog Number
• Catalog Number	ABS2EC01EA

[2] Dimensions mounted on DIN 3 (7.5 mm high) track.



ABR1E411F



ABR2E112E



ABR1S111F



ABR2S102B

Electromechanical Interface Modules

ABR electromechanical relay modules are for discrete digital input or output control signals exchanged in automated equipment. Features include:

- High contact reliability
- LED indication of the control signal state
- 5 separate character places for marking
- 35 mm DIN 3 or 32 mm DIN 1 track mountable

Table 23.175: Input Modules

Coil Voltage	Options	1 N.O. Contact	1 C.O. Contact	2 N.O. Contacts
		Catalog Number	Catalog Number	Catalog Number
24 Vac/Vdc	Manual Operator and LED Indication	ABR1E118B ^[3]	ABR1E318B ^[3]	ABR1E418B ^[3]
48 Vac/Vdc		ABR1E118E ^[3]	ABR1E318E ^[3]	ABR1E418E ^[3]
110–125 Vdc		ABR1E112F ^[3]	ABR1E312F ^[3]	ABR1E412F ^[3]
110–127 Vac 50/60 Hz		ABR1E111F ^[3]	ABR1E311F ^[3]	ABR1E411F ^[3]
230–240 Vac 50/60 Hz		ABR1E111M ^[3]	ABR1E311M ^[3]	ABR1E411M ^[3]
230–240 Vac 50/60 Hz	Manual Operator	ABR1E101M ^[3]	ABR1E301M ^[3]	—
24 Vdc	LED Indication	ABR2E112B	—	—
48 Vdc		ABR2E112E	—	—
120–127 Vac 60 Hz		ABR2E116F	—	—
230–240 Vac 50/60 Hz		ABR2E111M	—	—
24 Vdc		—	ABR2EB312B	—

Table 23.176: Output Modules

Coil Voltage	Options	1 N.O. Contact	1 C.O. Contact	2 N.O. Contacts	1 N.C. & 1 N.O. Contact
		Catalog Number	Catalog Number	Catalog Number	Catalog Number
24 Vdc	Manual Operator	ABR1S102B ^[3]	ABR1S302B ^[3]	ABR1S402B ^[3]	ABR1S602B ^[3]
24 Vac/Vdc	Manual Operator and LED Indication	ABR1S118B ^[3]	ABR1S318B ^[3]	ABR1S418B ^[3]	ABR1S618B ^[3]
48 Vac/Vdc		ABR1S118E ^[3]	ABR1S318E ^[3]	ABR1S418E ^[3]	ABR1S618E ^[3]
110–127 Vac 50/60 Hz		ABR1S111F ^[3]	ABR1S311F ^[3]	ABR1S411F ^[3]	ABR1S611F ^[3]
24 Vdc	LED Indication	ABR2S112B	—	—	—
48 Vdc		—	ABR2SB312B	—	—
24 Vdc		—	ABR2S102B	—	—

Table 23.177: Coil Data: ABR1E, ABR2E

Relay		ABR1E					ABR2E			
		24 Vac/Vdc	48 Vac/Vdc	127 Vdc	127 Vac	240 Vac	24 Vdc	48 Vdc	127 Vac	240 Vac
Coil Voltage U _e	V	24	48	127	127	240	24	48	127	240
Maximum Voltage	V	30	53	137	140	255	28.8	56	140	264
Pick-up Voltage	V	17	38	97	93	195	16.9	37.3	97	186
Minimum Sealed Current	mA	5.2	5.4	1.5	2.4	2	2	2	2.5	2.5
Maximum Sealed Current	mA	62	36	15	8	7	19.5	11	16	15

Table 23.178: Coil Data: ABR2EB, ABR1S, ABR2S, ABR2SB

Relay		ABR2EB	ABR1S			ABR2S	ABR2SB
		24 Vdc	24 Vdc	48 Vac/Vdc	127 Vac	24	24
Coil Voltage U _e	V	24 Vdc	24 Vdc	48 Vac/Vdc	127 Vac	24	24
Maximum Voltage	V	28.8	30	30	53	140	28.8
Pick-up Voltage	V	16.9	17	17	38	83	16.9
Minimum Sealed Current	mA	2	6.6	6.2	5.4	2.4	2
Maximum Sealed Current	mA	29	62	62	36	8	28

Table 23.179: Contact Ratings

Relay		ABR1E	ABR2E	ABR2EB	ABR1S	ABR2S	ABR2SB
Rated Voltage U _e	Vac	250	115	48	250	230	48
Rated Voltage U _e	Vdc	125	100	48	125	120	48
Thermal Current I _{th}	A	2	1	0.05	5	5	0.05
Break Rating (AC14)	A	1	0.5	1	1	1	—
Break Rating (DC13)	A	1	1	1	1	1.5	—

Table 23.180: Dimensions

Modules	Approximate Dimensions (WxDxH) ^[4]	
	In.	mm
ABR1E, ABR2EB, ABR2SB	0.69 x 2.91 x 2.78	17.5 x 74 x 70.5
ABR2E	0.37 x 2.91 x 2.78	9.5 x 74 x 70.5
ABR2S1	0.47 x 2.91 x 2.78	12 x 74 x 70.5

Approvals	
ABR1E, ABR2E	UL E164353, CSA 044087_S_000, IEC 60947-1
ABR1S, ABR2S	UL E164353, CSA 044087_S_000, IEC 60947-1

- ABR1 relays are RoHS compliant.
- For Mounting Track, see page 24-19.

^[3] RoHS Compliant
^[4] Dimensions mounted on DIN 3 (7.5 mm high) track.