

# H535



# Hawkeye™ 535 Enclosed Relay

### Installer's Specifications

Sensor Power	Induced from the monitored conductor
Amperage Range	0.25 to 15 A
Frequency Range	50-60 Hz
Operating Temperature Range	-15° to 50°C (5° to 122°F)
Operating Humidity Range	0-95%, noncondensing
Wire to Relay Contacts	Use 12 AWG (3.3 mm <sup>2</sup> ) wire or larger*
Relay Switching Capacity at 120 VAC	1 HP
Relay Output	SPST F.S. N.O. or N.C., 15 Amps
Relay Coil	24 VAC/DC; 36 mA nom.
Terminal Block Torque	Relay control terminals: 3.5 in-lb (0.4 N-m) All other terminals: 12 in-lb (1.35 N-m)
Agency Approvals	UL508, Installation Category III

\* For current loads up to 10A, use 75°C rated wire insulation. For loads greater than 10A, use 90°C rated wire insulation.

The product design provides for basic insulation only.



### HAZARD OF ELECTRIC SHOCK, EXPLOSION, OR ARC FLASH

- Follow safe electrical work practices. See NFPA 70E in the USA, or applicable local codes.
- This equipment must only be installed and serviced by qualified electrical personnel.
- Read, understand and follow the instructions before installing this product.
- Turn off all power supplying equipment before working on or inside the equipment.
- Use a properly rated voltage sensing device to confirm power is off.  
DO NOT DEPEND ON THIS PRODUCT FOR VOLTAGE INDICATION
- Only install this product on insulated conductors.

**Failure to follow these instructions will result in death or serious injury.**

## NOTICE

- This product is not intended for life or safety applications.
- Do not install this product in hazardous or classified locations.
- The installer is responsible for conformance to all applicable codes.
- Mount this product inside a suitable fire and electrical enclosure.

### QUICK INSTALL

1. Disconnect power sources prior to installation.
2. Remove the sensor lid and wire the command relay connections and relay controls to the base.
3. Set the relay contact jumper.
4. This device has four wiring options, detailed on page 2-3 of this installation guide. Choose the option appropriate to the application and follow instructions.

### OPERATION

The H535 combines a switching relay and a Hand-Off-Auto (HOA) switch in a single housing. The H535 is connected in series between the power source and the motor device. It operates at amperages up to a maximum of 15 A, and the relay and HOA switch control the on/off functioning of the motor. The H535 requires no additional power source for operation.

### DIMENSIONS

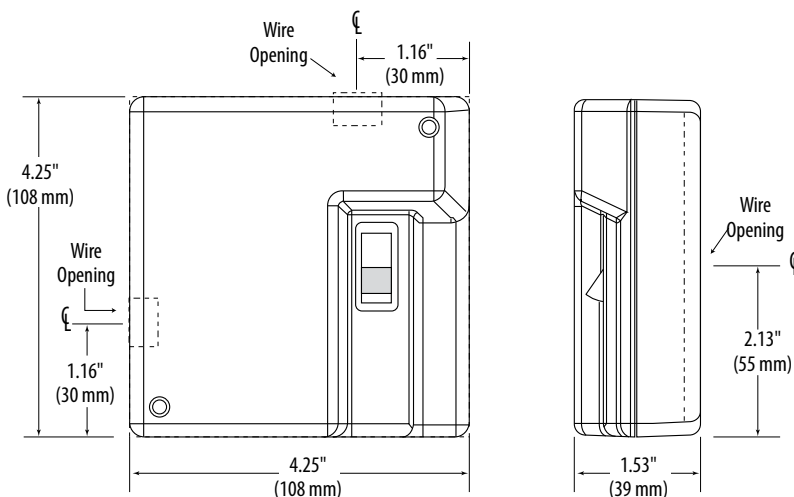

**WIRING BOARD**

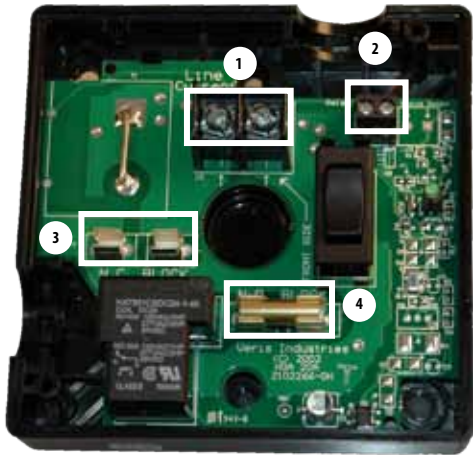

- 1. Line Current Terminals
- 2. 24VAC/DC Relay Control
- 3. N.C. Block
- 4. N.O. Block

4. Select one of the following mounting configurations (a, b, c, or d) to match your installation.

**a.) duplex box:**

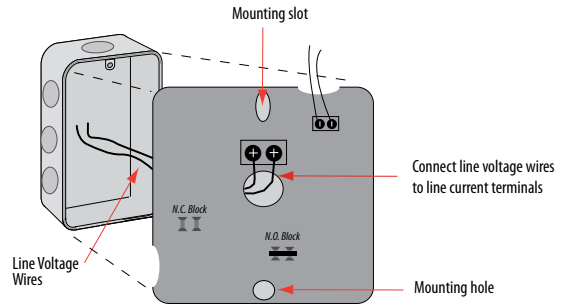

Wire the 12 AWG lines from the controller through the back of the device, to the line current terminals. Tighten line current terminal blocks to 12 in-lb. (1.35 N-m) torque. Use the base as a template for mounting to the wall using the mounting hole and slot shown.

**b.) 45 junction box:**

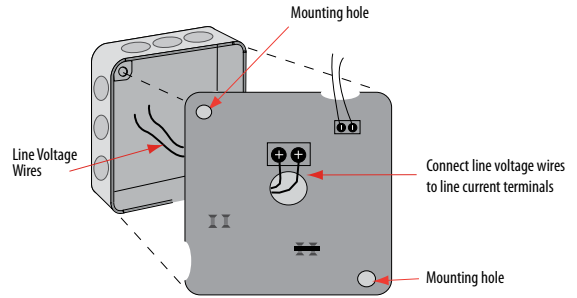

Wire the 12 AWG lines from the controller through the back of the device, to the line current terminals. Tighten line current terminal blocks to 12 in-lb. (1.35 N-m) torque. Use the base as a template for mounting to the wall using the mounting holes shown.

**c.) surface mounting:**

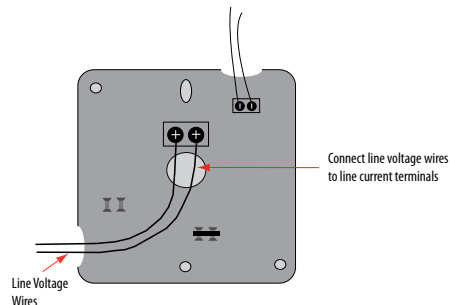

Wire the 12 AWG lines from the controller through the side of the device, onto the line current terminals. Tighten line current terminal blocks to 12 in-lb. (1.35 N-m) torque. Use the base as a template for mounting to the wall using any of the mounting holes shown.

**INSTALLATION**

**Prior to installation, disconnect and lock out all power sources.**

1. Open the device. Set aside the lid and the bag of hardware enclosed.



2. Wire the 24 AC/DC relay control through the top hole of the device. Use only copper conductors for command relay inputs. Tighten terminal blocks to 3.5 in-lb (0.4 N-m) torque. Keep wires away from the N. O. and N. C. jumper blocks.

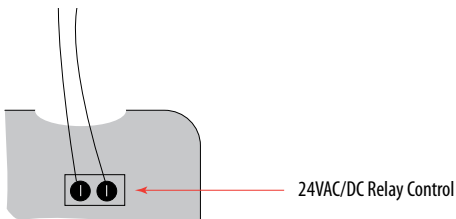

3. Set the relay contact jumper for N.O. or N. C. operation (the device is shipped with the jumper set in the N.O. position).

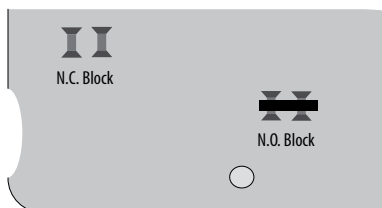

**d.) nipple mount to another enclosure:**

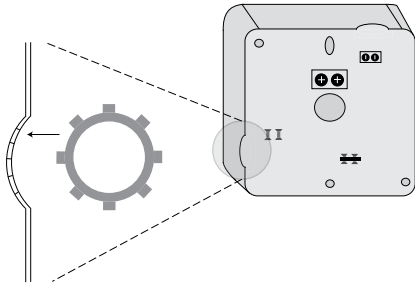

Insert the conduit nuts (provided) into the slots in the side hole of the device for additional weight support.

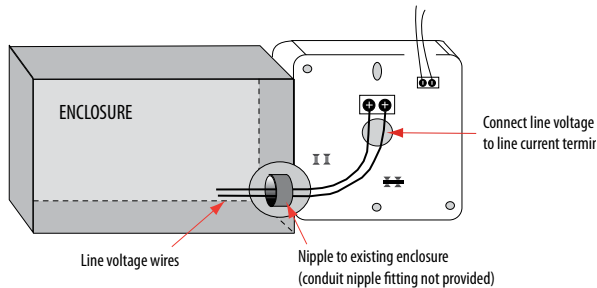

Wire the 12 AWG lines from the controller through the side of the device, from the enclosure to the line current terminals. Tighten line current terminal blocks to 12 in-lb. (1.35 N-m) torque.

5. Use the knockout seal to cover any unused holes in the housing. Attach the cover, securing with the screws provided.

*NOTE: If a conduit is used, connect the conduit to the mounting hub before connecting it to the device. Be sure to support the H535 housing when nipple-mounted to another enclosure, or the unit may shift on opening, potentially causing undue stress on the wiring and the terminals.*

**SETTING CONTACT JUMPER**

The H535 has a jumper for N.O. or N.C. relay function. The jumper affects the relay contacts only when the HOA switch is in AUTO. The product is shipped with the jumper in the N.O. position. To select N.C. function, move to the N.C. jumper block. Always disconnect power to the device before touching the jumper.

**WIRING EXAMPLE**

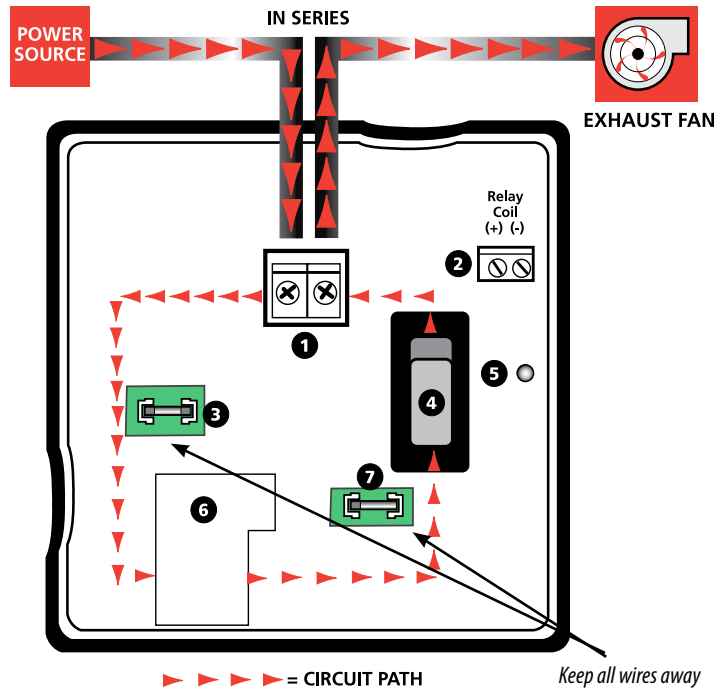

1. **Relay Contacts:** Wire the H535 in series with the load using these terminals.
2. **Relay Coil Terminal Blocks:** Wire the output signal from the control panel to actuate the relay. 24 VAC/DC; 36mA nominal
3. **N.C. Relay Jumper Block:** Insert a jumper here to ensure normally closed relay operation when the switch is in auto position. Disconnect power to the device before touching the jumper.
4. **H.O.A. Switch:** Control the motor locally.
  - HAND – When the switch is in this position, the motor is always on.
  - OFF – When the switch is in this position, the motor is always off.
  - AUTO – When the switch is in this position, the control system commands the motor.
5. **Relay Status LED:** For positive indication of energized coil.
6. **Relay:** Enables actuation of a circuit by a control system.
7. **N.O. Relay Jumper Block:** Insert a jumper here to ensure normally open relay operation when the switch is in auto. Disconnect power to the device before touching the jumper.

**CAUTION!**



Do not rely on status indicators to determine whether or not the relay contacts are connected to a power source. Doing so may result in injury or death from electrical shock.



If the connections to the unit are made through more than one metallic conduit, bond the conduits to prevent the hazard of electric shock. A bonding plate is available (Veris part AH10).