

H540/548



Hawkeye™ 540/548

Fractional HP Motor Status Sensor/ Command Relay

Installer's Specifications

Sensor Power	Induced from the monitored conductor
Amperage Range	H540: 0.25 to 15 A; H548: 0.5 to 15 A
Frequency Range	50-60 Hz
Operating Temperature Range	-15°C to 50°C (5° to 122°F)
Operating Humidity Range	0-95% non-condensing
Wire to Relay Contacts	Use 12 AWG (3.3 mm ²) or larger wire*
Terminal Block Torque	Relay control terminals: 3.5 in-lb (0.4 N-m) All other terminals: 12 in-lb (1.35 N-m)

Relay:

Switching Capacity at 120 VAC	1 HP
Relay Output	SPST F.S. N.O. or N.C.
Relay Coil	24 VAC/DC; 36 mA nom

Current Sensor:

Sensor Supply Voltage	Induced
Status Output Rating	N.O. 1.0 A at 30 VAC/DC
Trip Point	H540: Fixed (on/off status); H548: Adjustable (belt loss detection)
Agency Approvals	UL508, Installation Category III

* For current loads up to 10A, use 75°C rated wire insulation. For loads greater than 10A, use 90°C rated wire insulation.

Specification Note: For CE compliance, insulate conductor according to IEC 61010-1:2001. The product design provides for basic insulation only.

⚠ DANGER ⚡

HAZARD OF ELECTRIC SHOCK, EXPLOSION, OR ARC FLASH

- Follow safe electrical work practices. See NFPA 70E in the USA, or applicable local codes.
- This equipment must only be installed and serviced by qualified electrical personnel.
- Read, understand and follow the instructions before installing this product.
- Turn off all power supplying equipment before working on or inside the equipment.
- Use a properly rated voltage sensing device to confirm power is off.
DO NOT DEPEND ON THIS PRODUCT FOR VOLTAGE INDICATION
- Only install this product on insulated conductors.

Failure to follow these instructions will result in death or serious injury.

NOTICE

- This product is not intended for life or safety applications.
- Do not install this product in hazardous or classified locations.
- The installer is responsible for conformance to all applicable codes.
- Mount this product inside a suitable fire and electrical enclosure.

QUICK INSTALL

1. Disconnect power sources prior to installation.
2. Remove the sensor lid and wire the command relay connections and relay controls to the base.
3. Set the relay contact jumper.
4. This device has four wiring options, detailed on page 2-3 of this installation guide. Choose the option appropriate to the application and follow instructions.

OPERATION

The H540 and H548 devices combine a switching relay, a current status sensor, and a Hand-Off-Auto (HOA) switch into a single housing. The device is connected in series between the power source and the motor device, and the relay and HOA switch control the on/off functioning of the motor. The current switch trip point is fixed at 0.25 A on the H540 and adjustable from 0.5 to 15 A in the H548. The maximum load is 15 A for both devices. The H540 and H548 require no additional power source for operation.

DIMENSIONS

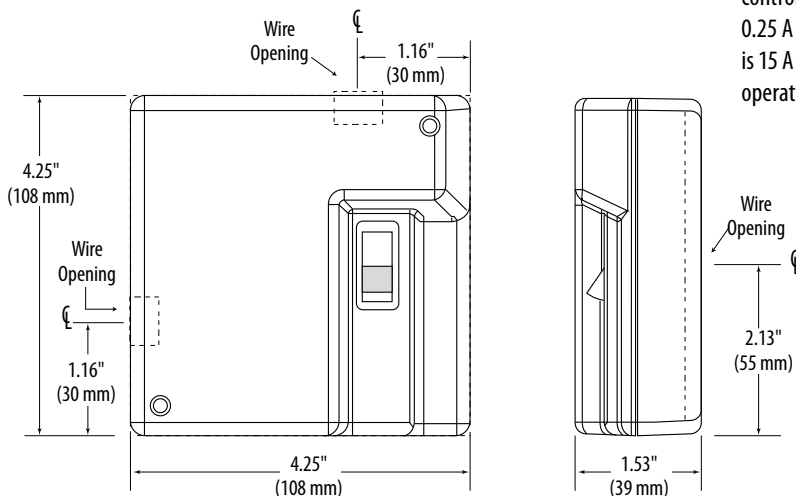

WIRING BOARD

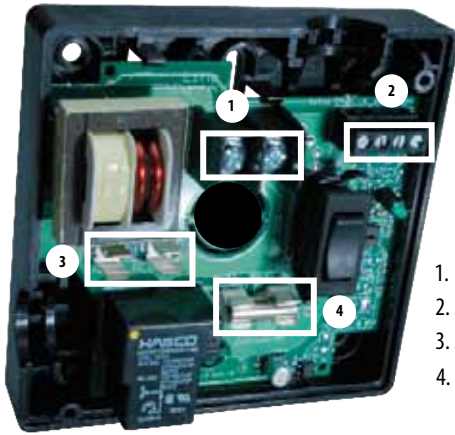

- 1. Line Current Terminals
- 2. 24VAC/DC Relay Control
- 3. N.C. Block
- 4. N.O. Block

4. Select one of the following mounting configurations (a, b, c, or d) to match your installation.

a.) duplex box:

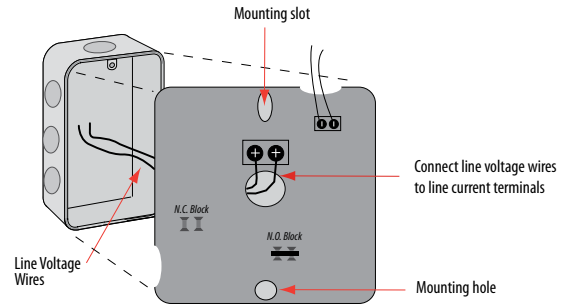

Wire the 12 AWG lines from the controller through the back of the device, to the line current terminals. Tighten line current terminal blocks to 12 in-lb. (1.35 N-m) torque. Use the base as a template for mounting to the wall using the mounting hole and slot shown.

b.) 45 junction box:

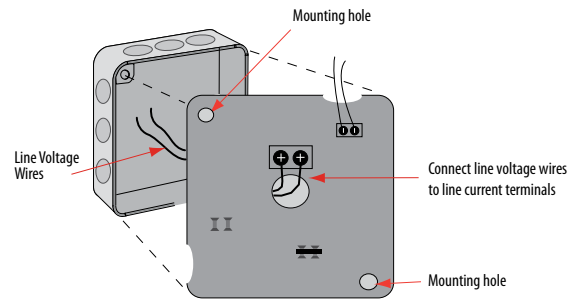

Wire the 12 AWG lines from the controller through the side of the device, onto the line current terminals. Tighten line current terminal blocks to 12 in-lb. (1.35 N-m) torque. Use the base as a template for mounting to the wall using any of the mounting holes shown.

c.) surface mounting:

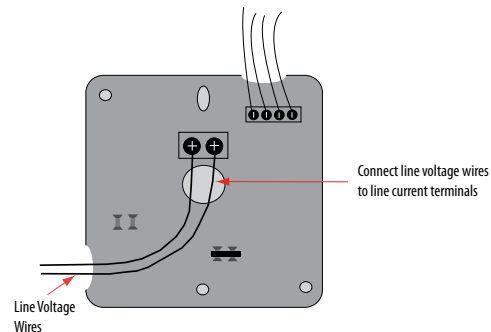

Wire the 12 AWG lines from the controller through the side of the device, onto the line current terminals. Tighten line current terminal blocks to 12 in-lb. (1.35 N-m) torque. Use the base as a template for mounting to the wall using any of the mounting holes shown.

INSTALLATION

Prior to installation, disconnect and lock out all power sources.

1. Open the device. Set aside the lid and the bag of hardware enclosed.



2. Wire the 24 AC/DC relay control through the top hole of the device. Use only copper conductors for command relay inputs. Tighten terminal blocks to 3.5 in-lb (0.4 N-m) torque. Keep wires away from the N. O. and N. C. jumper blocks.

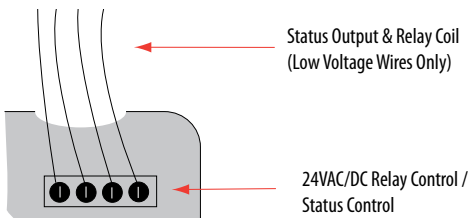

3. Set the relay contact jumper for N.O. or N. C. operation (the device is shipped with the jumper set in the N.O. position).

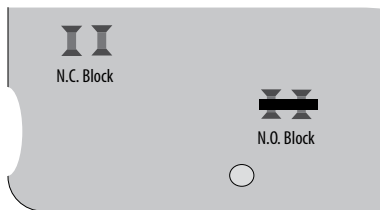

d.) nipple mount to another enclosure:

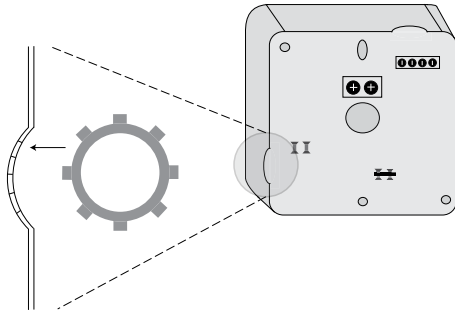

Insert the conduit nuts (provided) into the slots in the side hole of the device for additional weight support.

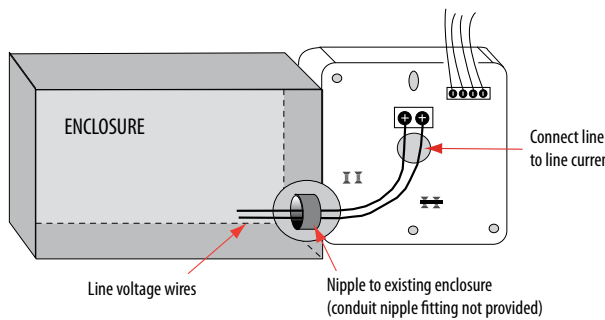

Wire the 12 AWG lines from the controller through the side of the device, from the enclosure to the line current terminals. Tighten line current terminal blocks to 12 in-lb. (1.35 N-m) torque.

5. Use the knockout seal to cover any unused holes in the housing. Attach the cover, securing with the screws provided.

NOTE: If a conduit is used, connect the conduit to the mounting hub before connecting it to the device. Be sure to support the H540/548 housing when nipple-mounted to another enclosure, or the unit may shift on opening, potentially causing undue stress on the wiring and the terminals.

CALIBRATION (H548 ONLY)

Note: Testing the solid-state status output of this sensor with a digital ohmmeter may yield inaccurate, but relative readings of switching (e.g. 6 MΩ) Use an analog V-O-M for readings similar to loop values. Calibration to be done while motor is running normally.

1. For under-current status indication: (Belt loss, fan & pump status)

- Turn the set point screw clockwise until the status closed LED goes out and the status open LED comes on.
- Turn the set point screw counter-clockwise until the status open LED goes out and the status closed LED comes on.
- Turn the set point screw 1/2 turn counter-clockwise.
- The sensor is now calibrated to provide indication of current flow below normal full load amps.

Output Status:

Normal: Output closed

Alarm: Output open

2. For over-current status indication: (Locked rotor)

- Turn the set point screw counter-clockwise until the status open LED goes out and the status closed LED comes on.
- Turn the set point screw clockwise until the status closed LED goes out and the status open LED comes on.
- Turn the set point screw clockwise 1/2 turn
- The sensor is now calibrated to provide indication of current flows above normal full load amps

Output Status:

Normal: Output open

Alarm: Output closed

WIRING EXAMPLE

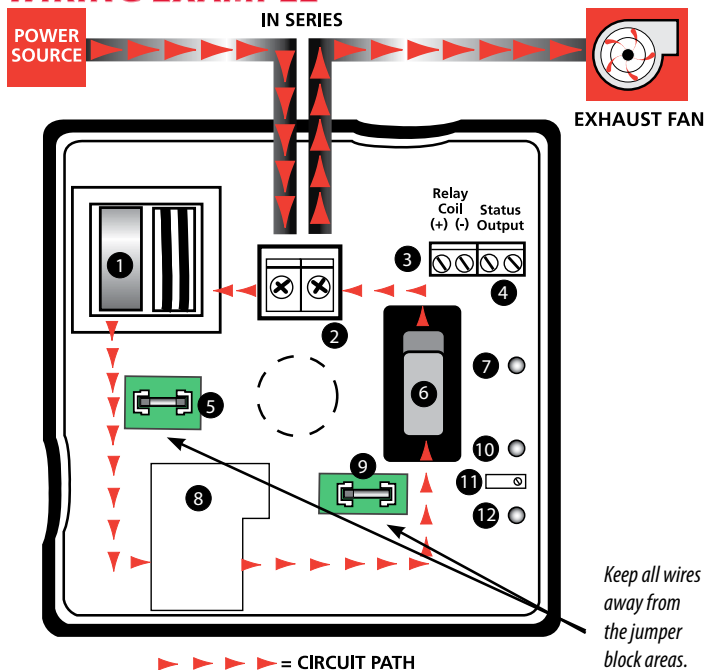

SETTING CONTACT JUMPER

The H540/548 has a jumper for N.O. or N.C. relay function. The jumper affects the relay contacts only when the HOA switch is in AUTO. The product is shipped with the jumper in the N.O. position. To select N.C. function, move to the N.C. jumper block. Always disconnect power to the device before touching the jumper.

1. **Current Sensor:** In-series current sensor for motor status.
2. **Power Terminal Block:** Wire the H540/548 in series with the motor using these terminals.
3. **Relay Coil Terminal Blocks:** Wire the output signal from the control panel to actuate the relay. 24 VAC/DC; 36mA nominal.
4. **Status Terminal Blocks:** Wire the status input back to the control panel.
5. **N.C. Relay Jumper Block:** Insert a jumper here to ensure normally closed relay operation when the switch is in auto. Disconnect power to the device before touching the jumper.
6. **H.O.A. Switch:** Control the motor locally.
 - HAND – When the switch is in this position, the motor is always on.
 - OFF – When the switch is in this position, the motor is always off.
 - AUTO – When the switch is in this position, the control system commands the motor.
7. **Relay Status LED:** For positive indication of energized coil.
8. **Relay:** Enables actuation of circuit by a control system.
9. **N.O. Relay Jumper Block:** Insert a jumper here to ensure normally open relay operation when the switch is in auto. Disconnect power to the device before touching the jumper.
10. **Status Open LED:** Indicates that the current is below the trip point and the status contact is open (used to calibrate the current switch in H548 models only).
11. **Current Switch Set-Point Screw:** Used to adjust the point in the current range at which the current switch will change states (used to calibrate the current switch in H548 models only).
12. **Status Closed LED:** Indicates that the current is above the trip point and the status contact is closed (used to calibrate the current switch in H548 models only).

CAUTION!



Do not rely on status indicators to determine whether or not the relay contacts are connected to a power source. Doing so may result in injury or death from electrical shock.



If the connections to the unit are made through more than one metallic conduit, bond the conduits to prevent the hazard of electric shock. A bonding plate is available (Veris part AH10).